

# GRILLES LOGIQUES

## 83 jeux de grilles

ABC End View	Grades	Portes — Seethrough
ABC Kombi	Gratte-ciel	Rectangles — Sikaku
ABC Path — Chemin ABC	Gyokuseki	Roma
Akari — Light up	Haltères	Ruisseau — Kuriku
Anglers	Hamilton	Salto
Aquarium — Waterfun	Hanare	Serpent — Snake — Tunnel
Arukone — Numberlink	Hidoku	Shirokuro
Bataille navale — Battleship	Hitori	Slant — Gogiken Naname
Binero — Takuzu	Kakkuru	Squaro
Briques	Kakurasu	Star
Burokku	Knossos	Stitches
Catwalk	Kuromasu	Sudoku
Clôture — Slither Link	Magnets	Sukoro
Démineur	Marguerite	Tairupeto
Diamants	Mastermind	Tentes — Tents & Trees
Disconnect Four	Meadows	Tetroid
Dominion	Météo	Thermomètres
Dominos	Mintonette	Toichika
Doughnut	Miroirs	Tra-vers
Entrée-Sortie — Entry-Exit	Morphism	Trace Numbers
Eulero	Nombres en chaîne	Tripletts
Faktorism	Nondango	Voisins — Neighbours
Fillomino	Number Cross	Walls
Fobidoshi	Patchwork — Tatami	Yakuso
Futoshiki — Inégal	Perles — Masyu	Zehnergitter
Fuzuli	Phares	Zipline
Galaxies — Tentai Show	Pipelink	Zwischenknick
Gappy	Ponts — Bridges	

Ce document propose 83 jeux de grilles logiques. Dont le sudoku, si connu, qui n'en est qu'un exemple.

Même si ce sujet voit actuellement de plus en plus de créations et de variantes (je parle bien de créations et non pas de déclinaisons sur l'e-toile), il n'est pas une invention de ces dernières années : Henry Dudeney a publié dans son *Amusements in Mathematics* en 1917 le problème 252, « A Puzzle for Motorists », grille dans laquelle il s'agissait de relier huit clochers et huit maisons sans que les chemins ne se croisent.

À travers ces grilles, des pistes de réflexions pédagogiques apparaissent aux yeux des enseignants. Il est en effet très enrichissant de voir comment les élèves lisent les énoncés, appliquent les consignes, hiérarchisent leurs réponses, procèdent par essais-erreurs, justifient leurs démarches, ... (Une activité en demi-groupe avec quelques grilles est à l'origine de ce document !)

Ce document propose quatre parties dans les pages suivantes.

**Règles** Pour chacun des 83 jeux de grilles sont donnés les règles, le but et un exemple (une grille à résoudre accompagnée de sa solution).

**Grilles** Les jeux de grilles sont rangés par leur ordre alphabétique. Suivant le site ou le livre que l'on parcourt, tel jeu peut avoir telle dénomination. Il n'est donc pas impossible d'avoir, pour un jeu, un nom français, un nom japonais (souvent, le nom original) et un nom anglais.

Chaque jeu de grille est décliné sur deux pages.

Lorsque des niveaux sont indiqués, ils sont déterminés par les auteurs des grilles.

Les tailles des grilles et de la police permettent, si besoin est, une impression au pourcentage de réduction 71 % (A3 → A4) de ces deux pages en une seule.

**Solutions** Chaque grille a une solution unique. Celle-ci est donnée systématiquement. Les numéros des pages d'énoncés et les numéros des pages des solutions sont les mêmes.

**Sources et ressources** Les présentes grilles sont extraites de sites, référencés. (Pour chaque type de grille, un seul site a alors été sélectionné, pour garantir une cohérence dans les niveaux de difficulté proposés.)

D'autres sites sont indiqués (sous forme de liens hypertextes), afin de trouver d'autres grilles. (Par ailleurs, de plus en plus d'applications Android proposent des grilles logiques !)

Grillez bien !

Arnaud Gazagnes (arnaud.gazagnes@ac-lyon.fr)

Groupe « Jeux » de l'IREM de Lyon

Groupe « Jeux et mathématiques » de l'APMEP

# Règles des jeux

## ABC End View

L'objectif est de remplir la grille carrée avec des lettres de sorte que chaque lettre ne figure qu'une seule fois sur chaque ligne et dans chaque colonne.  
 Certaines cases de la grille peuvent être vides.  
 Les lettres qui sont hors de la grille indiquent la première lettre qui apparaît sur la ligne (ou dans la colonne) appropriée depuis cet endroit.  
 L'indication « A → D » signifie qu'il faut utiliser les lettres A, B, C et D.

*Exemple*

		B		C	
C					
A					B
					B
	A		B		

*Grille à résoudre*

A → C

		B		C	
		B		A	C
C		C	B		A
A			A	C	B
		A	C	B	
	A		B		

*Grille solution*

## ABC Kombi

Le but du jeu est de remplir les cases d'une grille par des lettres selon les conditions suivantes :

- un nombre à gauche de la grille indique combien de fois la lettre correspondante, écrite au-dessus de ce nombre, apparaît dans la ligne correspondante ;
- un nombre en haut de la grille indique combien de fois la lettre correspondante, écrite à gauche de ce nombre, apparaît dans la colonne correspondante ;
- deux cases qui ont un côté commun ne peuvent pas contenir la même lettre.

*Exemple*

			<b>A</b>	2	2	2	2
			<b>B</b>	1	0	2	0
<b>A</b>	<b>B</b>	<b>C</b>		1	2	0	2
2	0	2					
2	1	1					
2	0	2					
2	2	0					

*Grille à résoudre*

			<b>A</b>	2	2	2	2
			<b>B</b>	1	0	2	0
<b>A</b>	<b>B</b>	<b>C</b>		1	2	0	2
2	0	2					
2	1	1					
2	0	2					
2	2	0					

A	C	A	C
C	A	B	A
A	C	A	C
B	A	B	A

*Grille solution*

## ABC Path — ABC Path

Le but du jeu est de placer dans chaque case de la grille une lettre (de A à Y), utilisée une fois seulement. Deux cases contenant deux lettres qui se suivent dans l'ordre alphabétique ont un côté ou un coin commun.

Une lettre placée sur le bord extérieur de la grille indique que cette lettre doit être placée dans la ligne, la colonne ou la diagonale correspondante.

*Exemple*

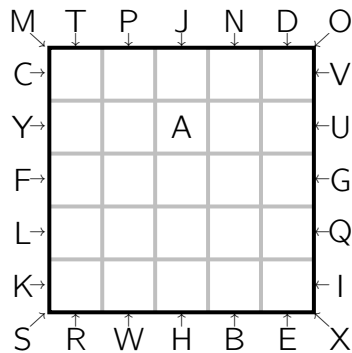

*Grille à résoudre*

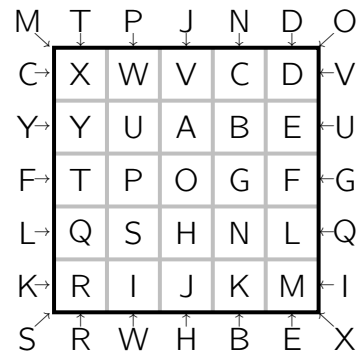

*Grille solution*

## Akari — Light up

La grille contient des cases blanches et des cases noires.

Le but est de placer des ampoules dans la grille afin d'illuminer toutes les cases blanches.

Une cellule est illuminée par une ampoule si celle-ci est placée dans la même colonne ou ligne et qu'il n'y a pas de case noire entre elles. Enfin, aucune ampoule ne peut en éclairer une autre.

Certaines cases noires contiennent un nombre : il indique combien d'ampoules se trouvent au contact de la cellule, horizontalement et verticalement.

*Exemple*

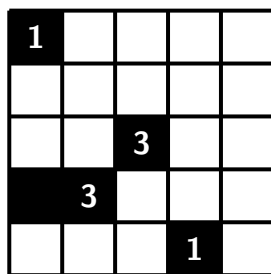

*Grille à résoudre*

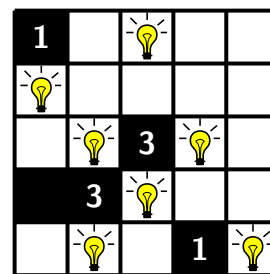

*Grille solution*

## Anglers

Le but du jeu est de relier chaque pêcheur placé dans une case contenant un nombre à un poisson par une ligne de pêche.

La ligne de pêche est une ligne brisée constituée de segments horizontaux ou verticaux.

Le nombre dans une case de pêcheur indique combien de cases sont traversées par la ligne de pêche, y compris les cases contenant le pêcheur et le poisson.

Une ligne ne doit pas se croiser ni, les cas échéant, croiser une autre ligne ; toutes les cases doivent être traversées, une fois et une fois seulement.

*Exemple*

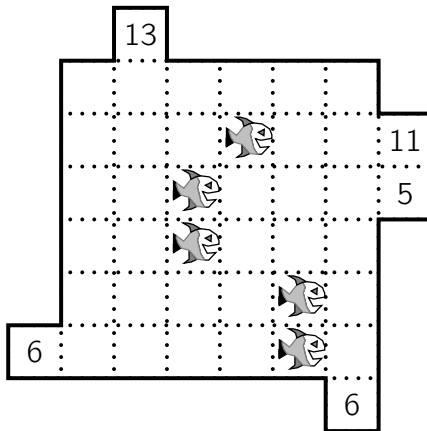

*Grille à résoudre*

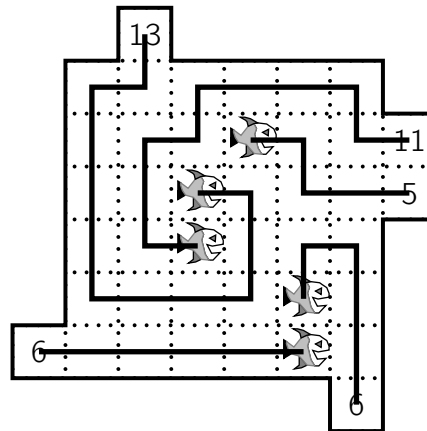

*Grille solution*

## Aquarium – Waterfun

Le jeu se joue sur une grille rectangulaire divisé en zones appelées « aquariums ». Le but est de remplir les aquariums avec de l'eau jusqu'à un certain niveau, ou bien les laisser vides. Le niveau d'eau de chaque aquarium est le même sur tout sa largeur. Les nombres sur les bords indiquent le nombre de cellules remplies, horizontalement et verticalement.

*Exemple*

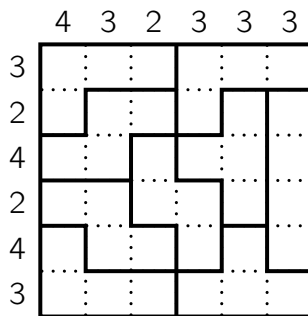

*Grille à résoudre*

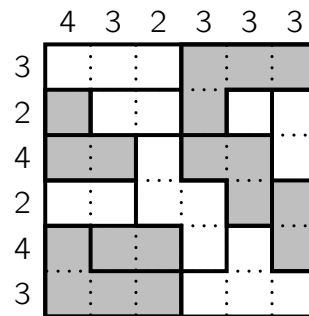

*Grille solution*

## Arukone — Numberlink

Sur une grille carrée quelques cases contiennent des paires de nombres, de 1 à 4. Le but est de relier chaque paire de nombres par une ligne brisée. Les segments tracés sont horizontaux ou verticaux. La ligne ne doit pas s'entrecroiser ou croiser une autre ligne. Toutes les cases de la grille doivent être traversées, une fois et une fois seulement.

*Exemple*

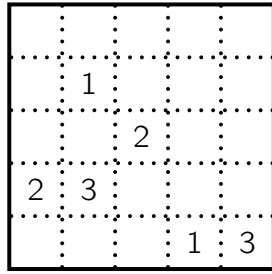

Grille à résoudre

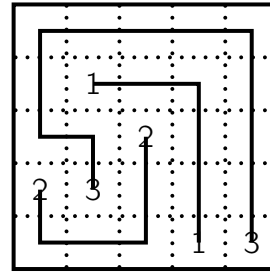

Grille solution

## Bataille navale — Battleship

Une flottille est cachée sur une grille.

Les bateaux qui la composent, représentés en-dessous en taille réelle, sont constitués de plusieurs parties (quatre pour les plus grands), occupant des cases différentes.

Ces bateaux sont placés horizontalement ou verticalement et ne se touchent pas, même en diagonale.

Les informations situées autour de la grille indiquent le nombre de cases de leur rangée occupées par des éléments de bateaux.

Une case marquée du signe  $\approx$  ne comporte que de l'eau.

Exemple

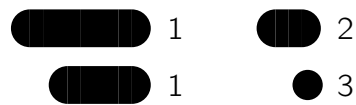
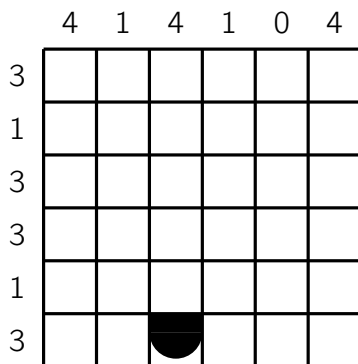

Grille à résoudre

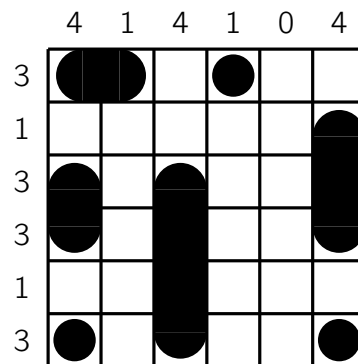

Grille solution

## Binero — Takuzu

Chaque grille ne contient que des 0 et des 1, et doit être complétée en respectant trois règles :

- il y a autant de 1 et de 0 sur chaque ligne et sur chaque colonne ;
- il n'y a pas plus de deux chiffres identiques côte à côte ;
- deux lignes ou deux colonnes ne peuvent être identiques.

Exemple

1	1		
0			0
		1	

Grille à résoudre

1	1	0	0
1	0	0	1
0	1	1	0
0	0	1	1

Grille solution

## Briques

Le but du jeu est d'écrire dans une grille de taille 6 les 6 nombres de 1 à 6 dans chaque ligne et chaque colonne.

Chaque brique doit contenir un nombre pair et un nombre impair.

Deux moitiés de brique sur les extrémités gauche et droite de la grille constituent une seule brique.

Exemple

			1	
	3			
	4			
		1		6
1				
		4		

Grille à résoudre

2	3	6	5	1	4
4	2	3	6	5	1
6	1	4	3	2	5
3	5	2	1	4	6
1	4	5	2	6	3
5	6	1	4	3	2

Grille solution

## Burokku

Le but du jeu est de diviser la grille de taille  $n \times n$  en  $n$  régions ne se chevauchant pas de  $n$  cases chacune. Une région ne doit pas contenir deux cases avec la même lettre.

Des parties de bords de région sont dessinés ; un bord de région ne peut pas passer par un point (situé en milieu de segment unité).

Exemple

B	D	B	A
C	C	C	A
D	D	B	A
A	D	C	B

Grille à résoudre

B	D	B	A
C	C	C	A
D	D	B	A
A	D	C	B

Grille solution

## Catwalk

Le but du jeu est de dessiner un chemin de chaque chat à son propre bol de lait.

Les nombres à gauche et au-dessous de la grille indiquent combien de cases sont traversées par ce chemin, chats et bols compris.

Les chats se promènent seulement horizontalement et verticalement et aucune case n'est visitée plus d'une fois.

*Exemple*

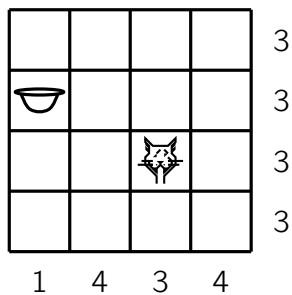

*Grille à résoudre*

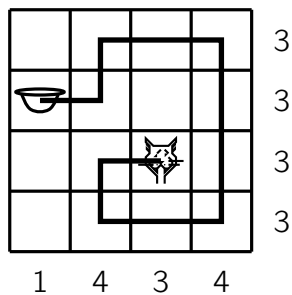

*Grille solution*

## Clôture — Slither Link — Surizarinku — Loop the loop

Le but du jeu est de retrouver l'emplacement de la clôture.

Les piquets de la clôture sont représentés par des croix (+).

La clôture est composée de segments horizontaux et verticaux joignant deux piquets et forme une boucle fermée qui ne se croise pas.

Les nombres (compris entre 0 et 3) situés dans les cases indiquent le nombre de segments de clôture entourant ces cases.

*Exemple*

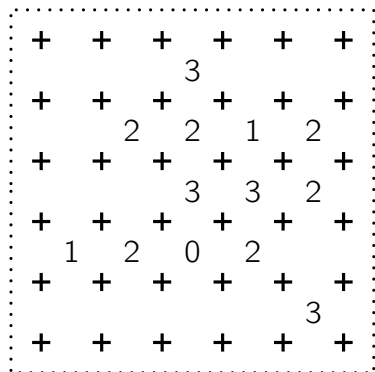

*Grille à résoudre*

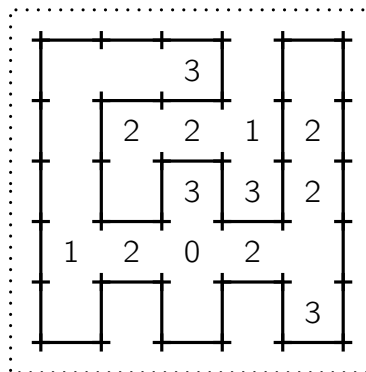

*Grille solution*

## Démineur

Le but du jeu est de retrouver les mines placées sur la grille.

Certaines cases comportent une information : le nombre de cases minées parmi ses huit voisines (diagonales comprises).

Les cases contenant ces nombres ne sont pas minées.



Exemple

	1	2		
	4		5	
			6	
2	3	3		1

Grille à résoudre

	1	2	☀	
	4	☀	5	☀
☀	☀	☀	6	☀
☀	☀	☀	☀	
2	3	3		1

Grille solution

## Diamants

Une zone contient des diamants enterrés.

En quelques endroits, on donne une valeur : celle-ci indique combien de cases contiennent un diamant (horizontalement, verticalement ou diagonalement) autour d'elle.

Une case avec une valeur ne contient jamais de diamant.

L'éventuelle valeur à côté de la figure indique combien de diamants au total sont dans la zone.

Exemple

	2	0	1	4	
0					2
	2			0	

Grille à résoudre

♦					♦
♦	2	0	1	4	♦
				♦	♦
0		♦			2
	2	♦		0	

Grille solution

## Disconnect Four

Le but du jeu est de remplir la grille avec des croix et des ronds de telle sorte qu'il n'y ait aucun alignement de quatre mêmes symboles à la suite, horizontalement, verticalement ou en diagonale.

Exemple

		○		+
+	+	+		
○			○	○
+			+	+
○			○	+

Grille à résoudre

+	○	○	○	+
+	+	+	○	+
○	+	○	○	○
+	+	○	+	+
○	○	+	○	+

Grille solution

## Dominion

Le but du jeu est de placer sur la grille, où trouvent des lettres, des dominos noirs selon les conditions suivantes :

- deux dominos ne peuvent se toucher, le cas échéant, que par un sommet ;
- les cases contenant une lettre doivent rester blanches ;
- les dominos partagent la grille en régions de couleur blanche ;
- les cases qui contiennent la même lettre appartiennent à la même région blanche ;
- toute région blanche comporte au moins une lettre.

Exemple

			D		C
				C	
E					C
			B		
	F			B	
F		A			
	A				
A		A			B

Grille à résoudre

			D		C
				C	
E					C
			B		
	F			B	
F		A			
	A				
A		A			B

Grille solution

## Dominos

Tous les dominos d'un jeu ont été placés sur une grille.

Les dominos vont du 0 · 0 au 3 · 3 pour les premières grilles (à 10 dominos) et du 0 · 0 au 4 · 4 pour les dernières grilles (à 15 dominos) ; leur liste est donnée au-dessous.

On a masqué les séparations entre les dominos en ne laissant visibles que leurs valeurs.

Le but du jeu est de retrouver leur disposition.

Exemple

1	1	0	3	0
3	3	0	1	1
1	2	3	2	0
2	2	3	2	0

Grille à résoudre

1	1	0	3	0
3	3	0	1	1
1	2	3	2	0
2	2	3	2	0

Grille solution

## Doughnut

Le but du jeu est de trouver un chemin qui relie les nombres donnés dans la grille dans l'ordre croissant.

Le chemin, composé de traits horizontaux et verticaux, passe par les centres des cases de la grille (vides ou contenant un nombre) et ne peut pas avoir de croisement.

Le chemin traverse une seule fois dans chaque case de la grille et chaque case de la grille est traversée.

La grille est à considérer comme un tore : lorsque le chemin sortira d'un côté (gauche, droit, haut et bas), il rentrera par le côté opposé (droit, gauche, bas et haut).

Exemple

	7		6
	1	5	
	4		
3		2	

Grille à résoudre

7			6
1		5	
4			
3		2	

Grille solution

## Entrée-Sortie — Entry-Exit

Le but du jeu est de tracer sur la grille une boucle vérifiant les conditions suivantes :

- la boucle passe par chaque case de la grille une fois seulement ;
- la boucle ne doit pas se croiser ;
- la boucle est constituée de segments horizontaux et verticaux passant par les centres des cases ;
- la boucle entre et sort dans chaque région une fois seulement.

Exemple

Grille à résoudre

Grille solution

## Eulero

Le but du jeu est de placer des chiffres et des lettres dans la grille selon les conditions suivantes :

- dans chaque ligne et chaque colonne d'une grille de taille 4, il y a les chiffres de 1 à 4 et les lettres de A à D et, dans chaque ligne et chaque colonne d'une grille de taille 5, il y a les chiffres de 1 à 5 et les lettres de A à E ;
- tout couple composé d'une lettre et d'un chiffre n'apparaît qu'une fois.

Exemple

	4		
		C	E
A	2		D 1
D			
3		2	

Grille à résoudre

C 2	A 4	E 1	B 3	D 5
B 1	D 3	C 5	A 2	E 4
A 5	E 2	B 4	D 1	C 3
D 4	C 1	A 3	E 5	B 2
E 3	B 5	D 2	C 4	A 1

Grille solution

## Faktorism

Le but du jeu de remplir la colonne de gauche et la ligne du haut par les dix entiers de 1 à 10. (Chaque nombre est donc utilisé une seule fois.)

Un nombre de la grille est le produit des nombres de la même ligne dans la colonne de gauche et de la même colonne de la ligne du haut.

*Exemple*

	16								
									81
		36							
	49								
							1		
			100						
								9	
		25							
					4				

*Grille à résoudre*

	4	7	6	5	10	8	2	1	3	9
4	16									
9										81
6			36							
7		49								
8										
1								1		
10					100					
3									9	
5				25						
2							4			

*Grille solution*

## Fillomino

Le but du jeu est de remplir toutes les cases de la grille par un nombre.

Les cases voisines (par un côté en commun) ayant la même valeur numérique forment un bloc.

Le nombre de cases du bloc est égal à la valeur écrite dans la case (par exemple, la valeur 2 doit regrouper deux cases voisines).

Deux groupes de cellules ayant la même valeur ne peuvent pas avoir de côté en commun.

*Exemple*

	4	1	2
		3	2
	3		3
		2	
4		2	

*Grille à résoudre*

4	4	1	4	2
4	4	3	4	2
1	3	3	4	3
4	4	2	4	3
4	4	2	1	3

*Grille solution*

## Fobidoshi

Dans la grille se trouvent quelques cercles.

Le but du jeu est de placer le plus de cercles possibles sachant que l'on ne peut pas avoir quatre disques sur un alignement horizontal ou vertical de quatre cases d'un seul tenant.

*Exemple*

○		○		○
	○			
○				○
○				○

Grille à résoudre

○		○	○	○
○	○	○		○
○			○	○
	○	○	○	
○	○		○	○

Grille solution

## Futoshiki — Inégal

Le jeu consiste à remplir une grille carrée dans laquelle sont inscrits des nombres allant de 1 à la taille de la grille.

Dans chaque ligne et chaque colonne, les nombres sont tous différents.

Les signes > (« plus grand que ») et < (« plus petit que ») entre les cases sont des indices qui doivent obligatoirement être respectés.

Exemple

1			
	∨		
		∧	∧
		∧	
		>	

Grille à résoudre

1	3	4	2
4	2	1	3
3	1	2	4
2	4	3	1

Grille solution

## Fuzuli

Le but du jeu est de remplir certaines cases de la grille par un nombre compris entre 1 et 3 afin que chaque nombre apparaisse une fois et une seule dans chaque ligne et chaque colonne.

Toute zone de dimensions  $2 \times 2$  doit contenir au moins une case vide.

Exemple

	1		3		
			1	2	
3		2	4		
				4	
			2		4

Grille à résoudre

2	1	4	3		
	4		1	2	3
3		2	4		1
4		1		3	2
1	2	3		4	
	3		2	1	4

Grille solution

## Galaxies — Tentai Show (— Sym-a-pix)

Le but est de partitionner la grille en blocs afin que chaque bloc ne contienne qu'un seul point, qui est son centre de symétrie.

*Exemple*

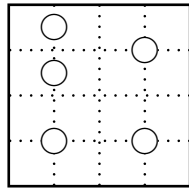

*Grille à résoudre*

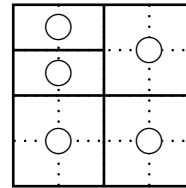

*Grille solution*

Une variante existe, Sym-a-pix (sans grille dans ce document). Le bloc a la même couleur que celle du centre de symétrie. Une image cachée apparaît à la fin.

## Gappy

Dans chaque ligne et chaque colonne, deux cases sont noires.

Deux cases noires ne peuvent se toucher ni par un côté ni par un coin.

Un nombre au bord de la grille indique le nombre de cases blanches entre les deux cases noires dans la ligne ou la colonne correspondante.

*Exemple*

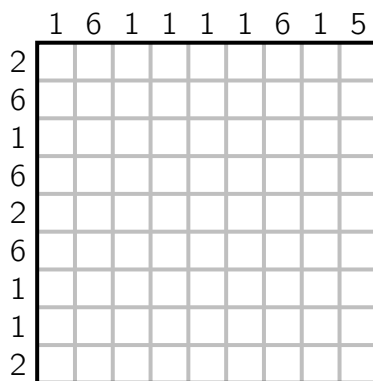

*Grille à résoudre*

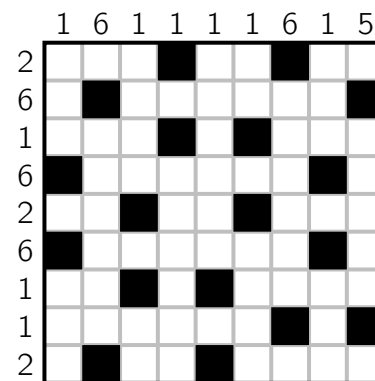

*Grille solution*

## Grades

Le but du jeu est d'écrire dans quelques cases d'une grille des nombres vérifiant les conditions suivantes :

- il ne peut pas y avoir deux nombres dans deux cases qui se touchent par un coin ou par un côté;
- le nombre en haut de chaque colonne indique le nombre de cases remplies dans cette colonne et le nombre en bas de cette colonne indique la somme des nombres écrits dans les cases de cette colonne;
- le nombre à gauche de chaque ligne indique le nombre de cases remplies dans cette ligne et le nombre à droite de cette ligne indique la somme des nombres écrits dans les cases de cette ligne.

*Exemple*

	1	0	2	1	2	1	
2							15
0							0
1							5
1							5
1							4
2							10
	1	0	13	5	15	5	

Grille à résoudre

	1	0	2	1	2	1	
2			9		6		15
0							0
1				5			5
1						5	5
1			4				4
2	1				9		10
	1	0	13	5	15	5	

Grille solution

## Gratte-ciel

Un bloc de la ville de New-York a été représenté dans une grille.

Chaque case contient un immeuble de 10, 20, 30 ou 40 étages.

Les immeubles d'une même rangée, ligne ou colonne, sont tous de tailles différentes.

Les informations données sur les bords indiquent le nombre d'immeubles visibles sur la rangée correspondante par un observateur situé à cet endroit.

Le but du jeu est de trouver la disposition des immeubles dans la grille.

Exemple

	1	3	2	2	
1					2
3					2
2					2
4					1
	3	2	2	1	

Grille à résoudre

	1	3	2	2	
1	40	10	20	30	2
3	20	30	40	10	2
2	30	40	10	20	2
4	10	20	30	40	1
	3	2	2	1	

Grille solution

## Gyokuseki

Le but du jeu est de placer des jetons blancs et noirs dans quelques cases d'une grille selon les conditions suivantes :

- chaque ligne et chaque colonne contiennent un jeton noir, et un seul, et au moins un jeton blanc ;
- un nombre placé sur un côté de la grille indique combien de jetons peuvent être vus dans la ligne ou la colonne correspondante, depuis le côté jusqu'au jeton noir, compris.

Exemple

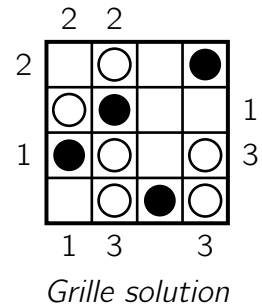
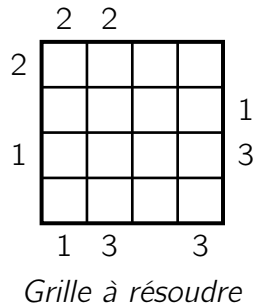

## Haltères

Des haltères doivent être rangées dans leur boîte.

Chaque haltère occupe trois cases alignées horizontalement ou verticalement : les cases des deux extrémités contiennent les poids, la barre se place dans la case centrale.

Les haltères peuvent se toucher mais non se croiser.

Chaque case contient au plus un poids, chaque poids étant l'extrémité d'une seule haltère.

Les emplacements des poids sont marqués au fond de la boîte.

Malheureusement, certains d'entre eux ont été effacés.

Le but du jeu est de retrouver les haltères se trouvant dans la grille (le nombre d'haltères à ranger dans la boîte est indiqué à côté celle-ci).

Exemple

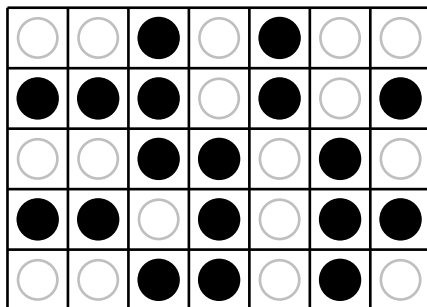

Grille à résoudre

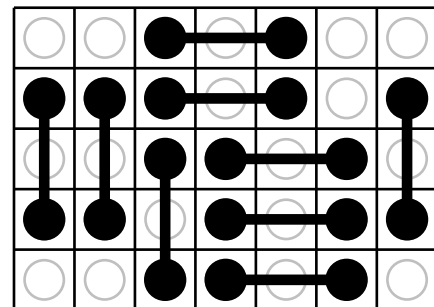

Grille solution

## Hamilton

Le but du jeu est de dessiner une boucle passant une fois, et une seule, par tous les nœuds.

Exemple

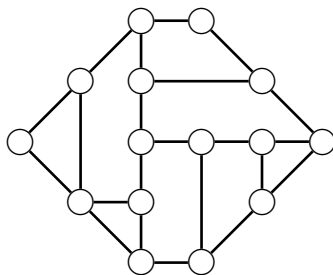

Grille à résoudre

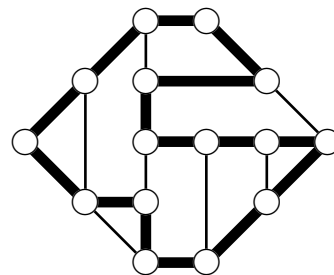

Grille solution



## Hanare

Le but est de mettre dans chaque région un nombre égal à son aire.

Le nombre de cases entre deux nombres écrits sur une même ligne horizontale ou verticale est égal à la différence de ces deux nombres.

*Exemple*

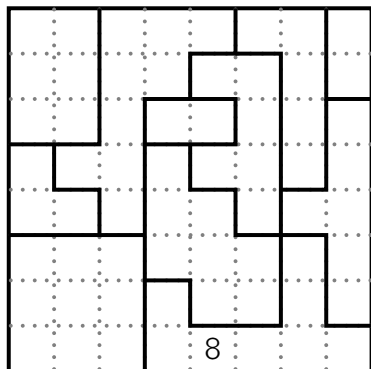

*Grille à résoudre*

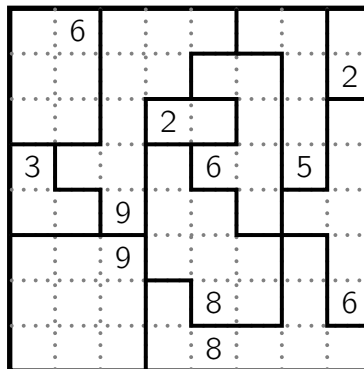

*Grille solution*

## Hidoku

L'objectif est de remplir toutes les cases de la grille carrée avec des nombres consécutifs qui sont reliés entre eux horizontalement, verticalement ou en diagonale.

Chaque puzzle contient les nombres minimal (1) et maximal (36). D'autres nombres peuvent aussi être présents sur le champ afin d'assurer la solution unique du jeu.

*Exemple*

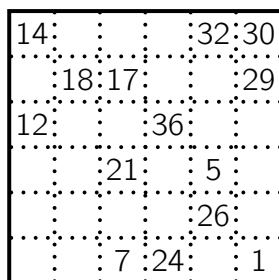

*Grille à résoudre*

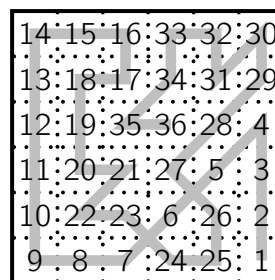

*Grille solution*

## Hitori

Chaque cellule la grille contient un chiffre.

Le but est de colorer des cellules de sorte qu'il n'y ait qu'un seul même chiffre non coloré par ligne et par colonne.

Les cellules colorées ne doivent pas se toucher par les côtés. Mais leurs coins peuvent se toucher. Toutes les cellules non colorées doivent être connectées par leurs côtés pour ne former qu'une seule pièce (on doit pouvoir parcourir toutes les cellules non colorées en passant de l'une à l'autre par un côté).

*Exemple*

1	1	1	2
2	3	1	4
2	2	4	3
3	4	3	1

Grille à résoudre

	1		2
2	3	1	4
	2	4	3
3	4		1

Grille solution

## Kakkuru

Le nombre cases vides dans une ligne (ou une colonne) étant désigné par  $N$ , le but du jeu est de remplir la grille selon les contraintes suivantes :

- les  $N$  nombres entiers de 1 à  $N$  sont présents dans chaque ligne et dans chaque colonne ;
- le nombre écrit dans une case indique la somme des entiers dans les cases adjacentes (chaque case a un nombre de cases adjacentes vides compris entre 1 et 8).

Exemple

		3	
	8		4
3	6		
1		6	

Grille à résoudre

1	2	3	1
2	8	1	4
3	6	2	1
1	1	6	2

Grille solution

## Kakurasu

Le but du jeu est de noircir certaines cases de la grille.

Les nombres à gauche de la grille indiquent la somme des « poids » des cases noires dans la ligne correspondante. Les nombres en haut de la grille indiquent la somme des « poids » des cases noires dans la colonne correspondante.

Le « poids » d'une case noire dans la première ligne ou la première colonne est 1, le « poids » d'une case noire dans la deuxième ligne ou la deuxième colonne est 2, et ainsi de suite.

Exemple

	5	6	1	2	
3					1
7					2
1					3
2					4
	1	2	3	4	

Grille à résoudre

	5	6	1	2	
3			■		1
7	■	■		■	2
1	■				3
2		■			4
	1	2	3	4	

Grille solution

## Knossos

Le but du jeu est de diviser la grille en régions ; chaque région contient une seule case avec un nombre : ce nombre est le périmètre de la région qui le contient.

Exemple

			6		6	6	
	8	8	8				
			10		10		
6							8
		8	8		8		
	10		6		8	6	
							4
10		8	8		8		6

Grille à résoudre

			6		6	6	
	8	8	8				
			10		10		
6							8
		8	8		8		
	10		6		8	6	
							4
10		8	8		8		6

Grille solution

## Kuromasu

La grille finale est remplie de cases blanches ou noires.

Certaines cases de la grille contiennent des nombres : ils représentent le nombre total de cases blanches visibles de la case où figure le nombre, dans les quatre directions (le total inclut la case elle-même).

Le but du jeu est de trouver toutes les cases noires, en respectant deux règles supplémentaires :

- deux cases noires ne peuvent pas avoir un côté commun mais elles peuvent avoir un sommet commun ;
- toutes les cases blanches doivent être connectées les unes aux autres par un chemin horizontal ou vertical composé d'autres cases blanches.

Exemple

	4	3	
		5	

Grille à résoudre

	4	3	
		5	

Grille solution

## Magnets

Le but du jeu est de retrouver les dominos aimantés de la grille.

Lorsqu'il est aimanté, un domino a un pôle positif (+) et un pôle négatif (-). Sinon il est neutre.

Les nombres placés à gauche de la grille donnent le nombre de pôles positifs de la ligne correspondante ;

les nombres placés en haut de la grille donnent le nombre de pôles positifs de la colonne correspondante.

Les nombres placés à droite de la grille donnent le nombre de pôles négatifs de la ligne correspondante ;

les nombres placés en bas de la grille donnent le nombre de pôles négatifs de la colonne correspondante.

Les extrémités de deux dominos ayant un côté commun ne peuvent pas avoir la même polarité.

Exemple

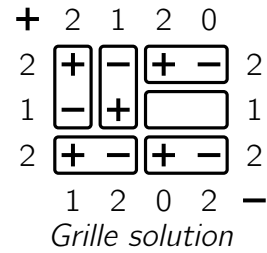
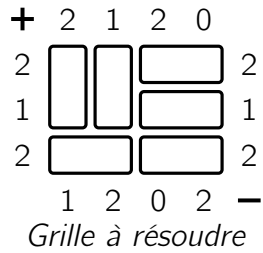

## Marguerite

Dans chacune des zones de la marguerite (centre et pétales) est inscrit un nombre. Il correspond au nombre de zones noircies, en comptant les zones adjacentes (qui ont un côté commun) et elle-même. Le but du jeu est de trouver l'emplacement des cases noircies.

*Exemple*

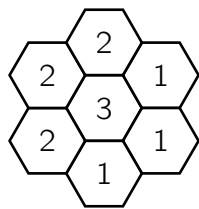

*Grille à résoudre*

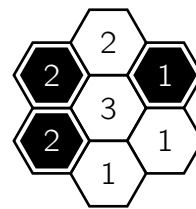

*Grille solution*

## Mastermind

Il s'agit de déterminer un code numérique basé sur les indices donnés.

Un indice se compose d'un code de nombre erroné et de deux indices : un nombre suivant le point noir ● indique combien des chiffres du code proposé sont corrects (valeur et position) et un nombre suivant le point blanc ○ indique combien de valeurs sont correctes, mais pas sur la position correcte.

*Exemple*

6	2	3	4	●	1	○	0
7	1	2	6	●	1	○	0
3	7	6	8	●	1	○	1
5	6	1	2	●	1	○	1
				●	4	○	0

*Grille à résoudre*

6	2	3	4	●	1	○	0
7	1	2	6	●	1	○	0
3	7	6	8	●	1	○	1
5	6	1	2	●	1	○	1
5	1	3	8	●	4	○	0

*Grille solution*

## Meadows

Le but du jeu est de retrouver tous les carrés de la grille avec les deux conditions suivantes :

- Les carrés ne se superposent pas et ne laissent pas d'espace vide dans la grille.
- Chaque carré contient un seul point et un point appartient à un seul champ.

*Exemple*

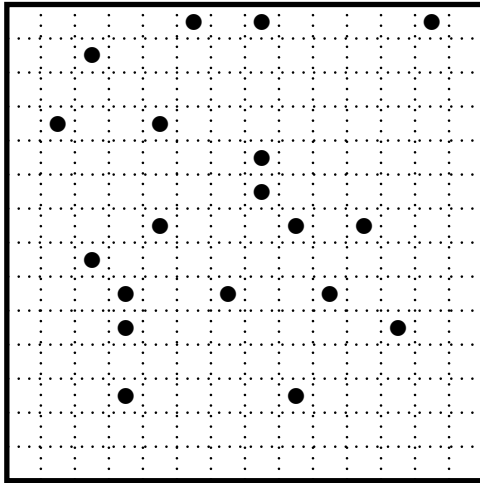

Grille à résoudre

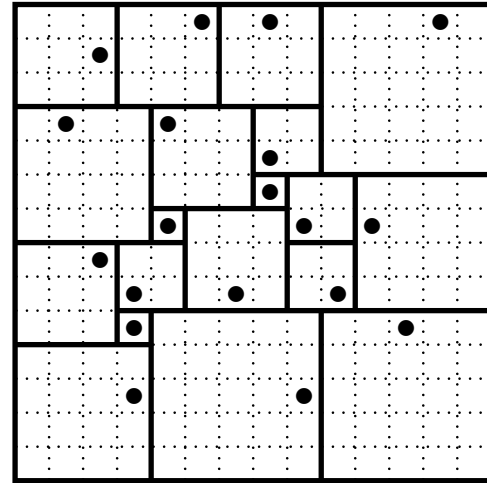

Grille solution

## Météo

Sur cette carte, il y a exactement un soleil et un nuage par ligne et par colonne.

Les indices donnent le nombre de soleils visibles depuis l'indice, dans les quatre directions.

Naturellement un soleil n'est visible depuis un indice que s'il n'y a pas de nuage entre lui et l'indice.

Les cases contenant un indice ne peuvent contenir ni soleil ni nuage.

Le but du jeu est de placer les soleils et les nuages sur les cartes.

Exemple

			0	
				2
1	2		2	
1			1	

Grille à résoudre

☀	☁		0	
			☁	☀
☁			☀	2
1	2	☀	2	☁
1	☀	☁	1	

Grille solution

## Mintonette

Certaines cases de la grille comportent un jeton numéroté ou marqué d'un point d'interrogation.

Le but du jeu est de relier les jetons selon les conditions suivantes :

- les jetons se regroupent par paires ;
- les jetons sont reliés par des lignes brisées formées de segments horizontaux et verticaux passant par les centre des cases ;
- le nombre sur un jeton est le nombre d'angles droits que peut former la ligne brisée entre deux jetons (de même valeur) ;
- un point d'interrogation représente un nombre entier non nul ;
- un jeton n'appartient qu'à une seule ligne brisée ;
- les lignes brisées traversent toutes les cases mais ne doivent pas se croiser.

Exemple

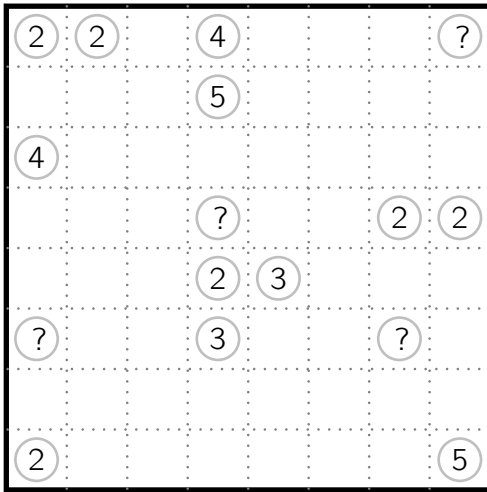

Grille à résoudre

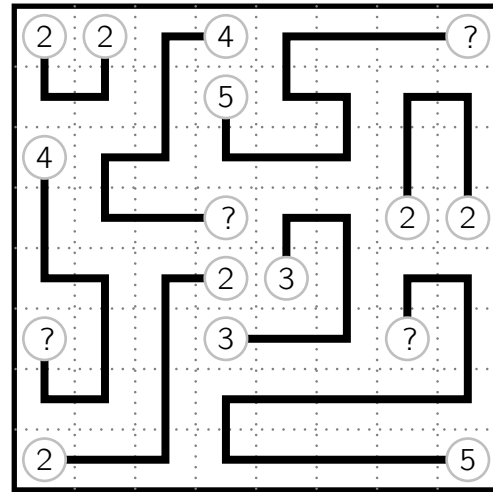

Grille solution

## Miroirs

La grille comporte un certain nombre de miroirs.

Dans chaque case vide, il faut placer un fantôme , un vampire  ou un zombie .

Un fantôme est visible seulement quand il est reflété dans un miroir ; un vampire est visible directement et pas dans un miroir ; un zombie est toujours visible (directement et dans un miroir). Chacun peut être vu plus d'une fois.

Les numéros autour des bords de grille montrent combien de ces créatures sont visibles en examinant la rangée (la colonne) correspondante. Les nombres totaux de fantômes, de vampires et de zombies sont aussi donnés.

Exemple

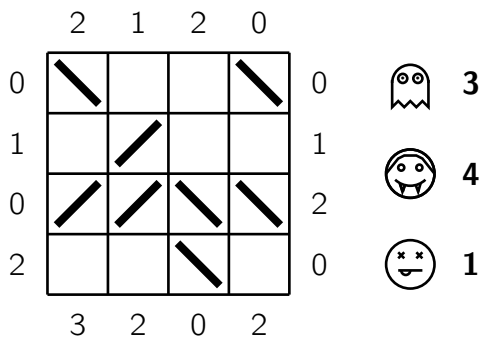

Grille à résoudre

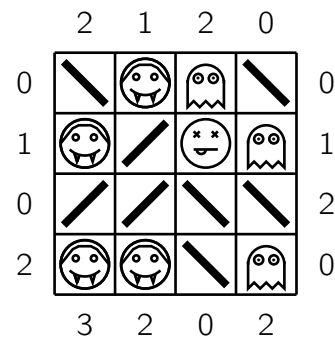

Grille solution

## Morphism

Les deux graphes ont une structure identique, mais leurs sommets ont été réorganisés.

Le but du jeu est d'écrire les lettres correspondantes aux sommets au bon endroit.

Il importe seulement de savoir quels sommets sont reliés par des arêtes. Les longueurs des arêtes et les croisements d'arêtes n'ont aucune importance.

Exemple

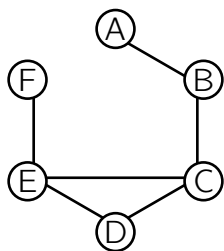

Grille à résoudre

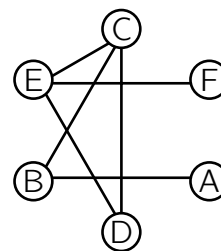
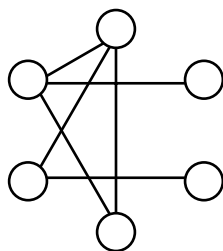

Grille solution

## Nombres en chaîne – Meandering Numbers

Le but du jeu est de remplir la grille avec des nombres selon les conditions suivantes :

- chaque case contient un nombre ;
- chaque région de  $N$  cases contient chacun des  $N$  nombres entiers de 1 à  $N$  ;
- un même nombre ne peut pas se situer dans deux cases adjacentes ou deux cases en diagonale ;
- la case de tout nombre  $n$  doit être une case adjacente contenant le nombre  $n - 1$  (excepté 1) et être une case adjacente contenant le nombre  $n + 1$  (excepté  $N$ ).

Exemple

1			6		
					3
3	4				
		5			
			4		6

1	6	7	6	1	2
2	5	1	5	4	3
3	4	2	7	6	5
2	1	3	4	3	4
3	4	5	1	2	7
1	2	3	4	5	6

## Nondango

Le but du jeu est de noircir certains des jetons blancs de la grille.

Dans chaque région, il y a un et un seul jeton noir.

Il ne peut pas y avoir trois jetons de la même couleur horizontalement, verticalement ou en diagonale sans jeton d'une couleur différente ou une case vide entre.

Exemple

		○		○	
○	○	○	○	○	
○		○		○	
○	○			○	
	○			○	
	○	○	○	○	

Grille à résoudre

		○		●	
○	○	●	●	○	
●		○		○	
●	○			●	
	●			●	
	●	○	●	○	

Grille solution

## Number Cross

Le but du jeu est de noircir des cases de la grille de telle sorte que la somme des nombres des cases non noircies soit égale au nombre indiqué en haut de la colonne et à gauche de la ligne.

Exemple

	11	21	7	13	8
19	2	3	7	7	7
8	4	1	8	3	1
7	9	9	6	7	3
12	2	9	1	3	1
14	5	9	3	6	3

Grille à résoudre

	11	21	7	13	8
19	2	3	7		7
8	4			3	1
7				7	
12		9		3	
14	5	9			

Grille solution

## Patchwork — Tatami

Le but du jeu est de placer dans chaque rectangle de longueur  $N$  tous les nombres de 1 à  $N$ . Dans une ligne ou une colonne, chaque nombre est écrit autant de fois que les autres. Deux nombres situés dans deux cases qui ont un côté commun doivent être différents.

Exemple

			4	1	
1		1			
		4	2		
		2			
1			2		
					4

Grille à résoudre

3	2	1	2	4	3	1	4
1	4	3	1	3	2	4	2
2	1	4	3	2	4	3	1
4	3	1	2	4	1	2	3
3	1	2	4	1	3	4	2
4	2	4	1	3	2	3	1
1	4	3	4	2	1	2	3
2	3	2	3	1	4	1	4

Grille solution

## Perles — Masyu

Le but du jeu est de relier toutes les perles (noires et blanches) en une boucle qui ne se coupe pas. La boucle ne doit pas nécessairement passer par toutes les cases de la grille ; elle doit cependant passer par toutes les perles.

Dans chaque case traversée, le morceau de boucle est soit droit soit à angle droit selon les deux règles suivantes :

- dans une case de perle blanche, le trait doit être droit, mais il doit être en angle droit dans la case qui le précède ou qui la succède ;



- dans une case de perle noire, le trait doit être en angle droit, mais les cases précédente et suivante de son parcours doivent contenir des traits droits.

Exemple

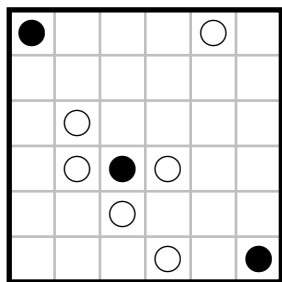

Grille à résoudre

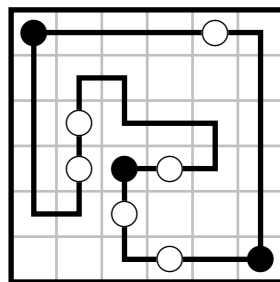

Grille solution

## Phares

Dans le port intérieur de l'Océanie, il y a quelques phares et quelques bateaux.

Les phares sont déjà marqués sur la carte.

Le nombre dans un phare indique combien de bateaux sont éclairés par le phare.

Un bateau est éclairé s'il est dans la ligne ou la colonne d'un phare, même s'il est derrière d'autres bateaux ou d'autres phares.

Chaque bateau est éclairé par au moins un phare.

Les bateaux ne se touchent pas entre eux ni ne touchent des phares, horizontalement, verticalement ou diagonalement.

Le but du jeu est de localiser les bateaux sur la carte !

Exemple

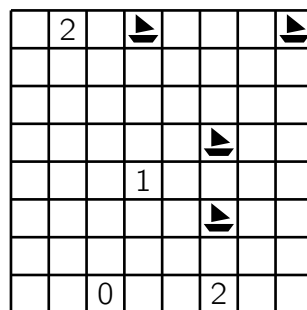
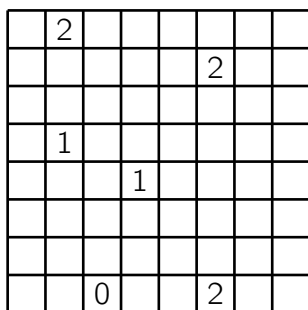

## Pipelink

Il s'agit de dessiner une boucle fermée, en reliant horizontalement ou verticalement les centres des cases du diagramme.

La boucle doit passer par toutes les cellules, doit utiliser tous les segments imposés et peut se croiser dans n'importe quelle cellule.

Exemple

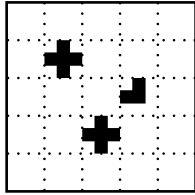

Grille à résoudre

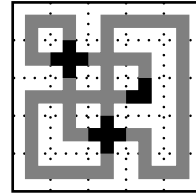

Grille solution

## Ponts — Bridges — Hashiwokakero

Le but du jeu est de connecter toutes les îles en un seul groupe interconnecté en dessinant des ponts entre les îles.

Les ponts doivent suivre certains critères :

- ils doivent commencer et finir sur des îles distinctes, selon une ligne droite ;
- ils ne doivent pas croiser d'autres ponts ou îles ;
- ils ne sont que verticaux ou horizontaux ;
- il y a au plus deux ponts entre deux îles ;
- le nombre de ponts partant de chaque île doit correspondre au nombre indiqué sur l'île.

Exemple

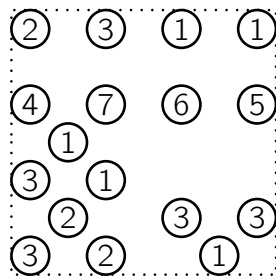

Grille à résoudre

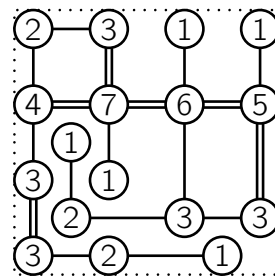

Grille solution

## Portes — Seethrough

Chaque cellule la grille est une pièce dans un bâtiment.

Il y a une porte (ouvertes ou fermées) entre deux pièces adjacentes.

Le nombre dans une pièce indique combien on peut voir d'autres pièces dans les quatre directions (le nord, le sud, l'est et l'ouest).

Le but est de placer les portes fermées qui ne sont pas dessinées.

Exemple

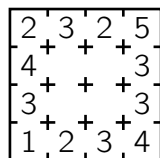

Grille à résoudre

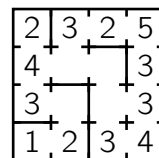

Grille solution

## Rectangles — Sikaku

Le but est de partager le carré en un ensemble de rectangles sachant que chaque rectangle contient exactement un nombre et que son aire est égale à cette valeur.

Exemple

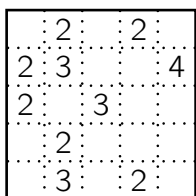

Grille à résoudre

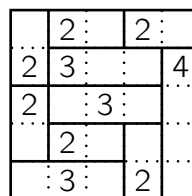

Grille solution

## Roma

Le but du jeu est de placer dans chaque case une flèche dirigée vers le haut, la gauche, le bas ou la droite. Dans une même zone, les flèches pointent vers des directions différentes.

En partant de n'importe quelle case, et en suivant les flèches, on arrive à la fin du trajet à la case marquée d'un point noir.

Exemple

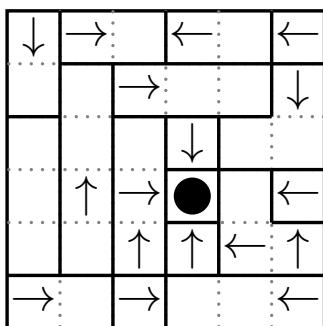

Grille à résoudre

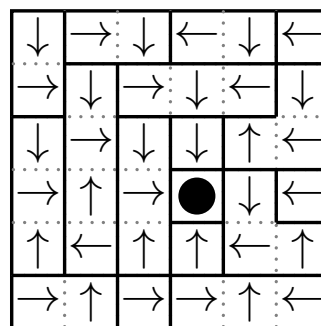

Grille solution

## Ruisseau — Kuriku

Sur la grille se trouvent des jetons recouvrant en partie des cases.

Ils sont marqués d'un nombre compris entre 0 et 4 : ce nombre indique combien de cases noires sont recouvertes.

Le but du jeu est de retrouver toutes les cases noires.

Les cases blanches forment un ensemble connexe (d'un seul tenant).

Exemple

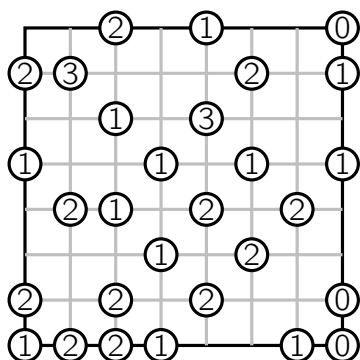

Grille à résoudre

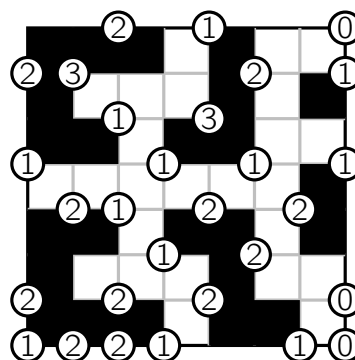

Grille solution

## Salto

Le but du jeu est de parcourir toute la piste en partant de la case en haut à gauche en avançant par sauts de 1, 2 ou 3 cases pour les grilles  $5 \times 5$  et  $6 \times 6$  et 1, 2, 3 ou 4 cases pour les grilles  $7 \times 7$ .

Les cases sur lesquelles on se pose sont marquées de la longueur du saut suivant.

Dans chaque ligne et chaque colonne les nombres doivent être tous différents.

Certains cases sont déjà marquées.

*Exemple*

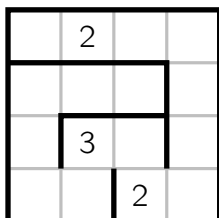

*Grille à résoudre*

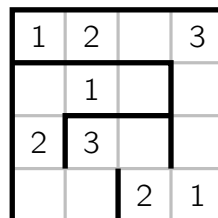

*Grille solution*

## Serpent — Snake — Tunnel

Le but du jeu est de remplir la grille par des cases noires, qui vont former un « serpent », d'une case de large.

Ce « serpent » commence et termine dans les deux cases données et ne se touche jamais, même en diagonale.

Un nombre en haut d'une colonne indique le nombre de cases noires dans cette colonne et un nombre à gauche d'une ligne indique le nombre de cases noires dans cette ligne.

*Exemple*

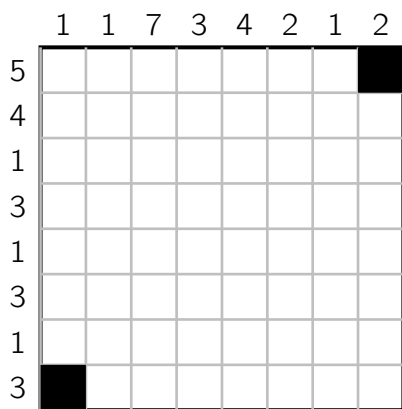

*Grille à résoudre*

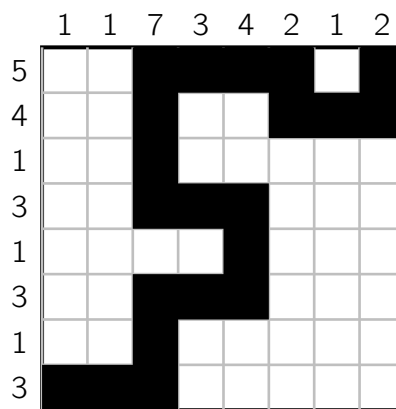

*Grille solution*

## Shirokuro

Le but du jeu est de relier chaque jeton blanc à un jeton noir par un segment horizontal ou vertical.

Il n'y a qu'un seul segment lié à un jeton.

Les segments ne se croisent pas.

*Exemple*

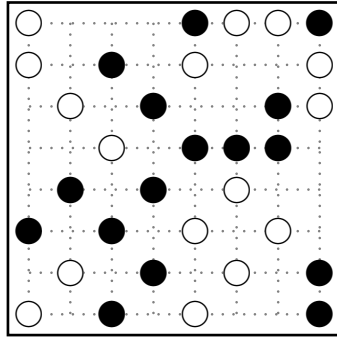

Grille à résoudre

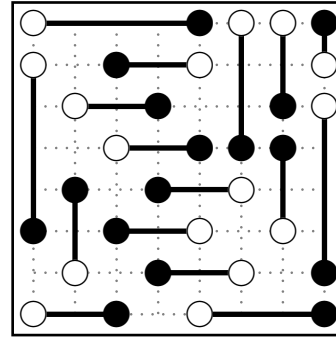

Grille solution

## Slant — Gogiken Naname

Le but du jeu est de dessiner, dans chacune des cases, l'une de ses deux diagonales de telle sorte que le nombre placé à un nœud du quadrillage indique combien de segments sont reliés à ce nœud. Les lignes brisées ne doivent pas former une boucle fermée.

Exemple

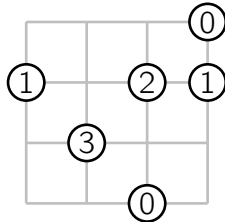

Grille à résoudre

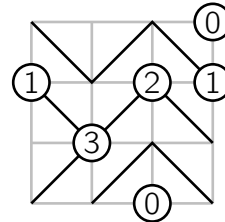

Grille solution

## Squaro

Dans chacune des cases se trouve un nombre, 0 à 4 : il correspond au nombre de ronds à colorier parmi ceux situés aux quatre coins de cette case.

Exemple

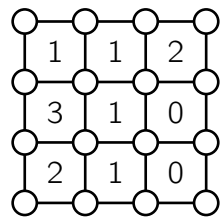

Grille à résoudre

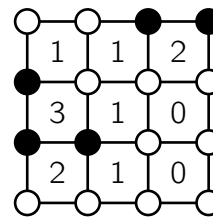

Grille solution

## Star

Le but du jeu est de retrouver la position des étoiles. Il y a une étoile par ligne, par colonne et par région. De plus, les étoiles ne se touchent pas, même en diagonale.

Exemple

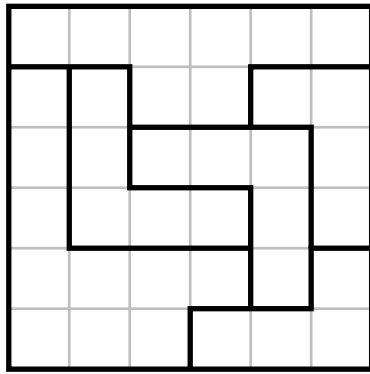

Grille à résoudre

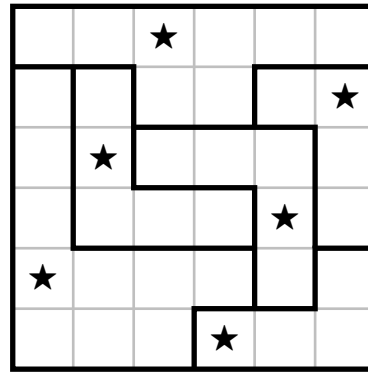

Grille solution

## Stitches

Le but du jeu est de relier chaque région avec toutes les régions adjacentes (par les côtés) avec exactement un segment de longueur 1 chacun (ainsi, les deux extrémités du segment sont dans deux cases adjacentes (par un côté)).

Une case peut être traversée au plus par un seul segment ; les cases ne sont pas toutes traversées par un segment.

Un nombre au bord de la grille indique le nombre d'extrémités dans la ligne ou la colonne correspondante.

*Exemple*

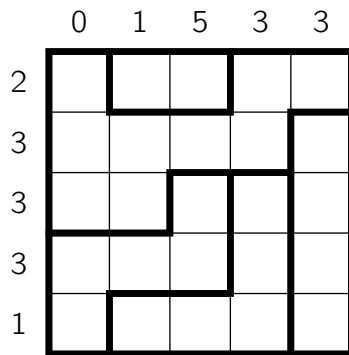

Grille à résoudre

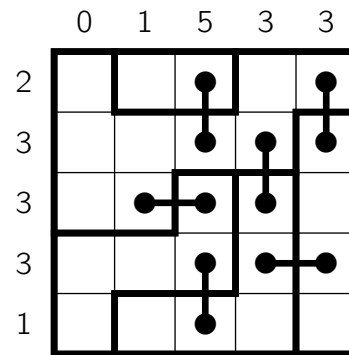

Grille solution

## Sudoku

Un sudoku est une grille qui contient neuf lignes et neuf colonnes, donc 81 cases au total.

Le but du jeu est de remplir ces cases avec des chiffres allant de 1 à 9 en veillant toujours à ce qu'un même chiffre ne figure qu'une seule fois par colonne, une seule fois par ligne, et une seule fois par carré de neuf cases.

*Exemple*

	6			9			5	
7		1				2		9
	8		2		1		4	
		9	6	7	3	4		
3			9		2			5
		6	8	5	4	9		
	4		7		9		3	
1		7				5		8
	9			8			2	

Grille à résoudre

4	6	2	3	9	7	8	5	1
7	3	1	5	4	8	2	6	9
9	8	5	2	6	1	3	4	7
8	5	9	6	7	3	4	1	2
3	7	4	9	1	2	6	8	5
2	1	6	8	5	4	9	7	3
5	4	8	7	2	9	1	3	6
1	2	7	4	3	6	5	9	8
6	9	3	1	8	5	7	2	4

Grille solution

## Sukoro

Le but du jeu est d'écrire dans quelques cases d'une grille des nombres de 1 à 4 vérifiant les conditions suivantes :

- le nombre inscrit dans une case indique le nombre de cases adjacentes (horizontalement et verticalement) qui contiennent aussi un nombre ;
- deux cases adjacentes ne peuvent pas contenir le même nombre ;
- toutes les cases contenant un nombre forme une zone connexe (d'un seul tenant).

Exemple

		1				1
	1		3		3	2
	2		4		4	
3	1		1		3	
1				1		

Grille à résoudre

1		1	2			1
3	1		3	2	3	2
2			2		2	
3	2	3	4	2	4	1
2		2	3		2	
3	1		1		3	1
1				1	2	

Grille solution

## Tairupeto

Le but du jeu est de noircir certaines zones de la grille, sachant que le nombre au début de la ligne ou de la colonne indique le nombre de cases noires dans celle-ci.

Exemple

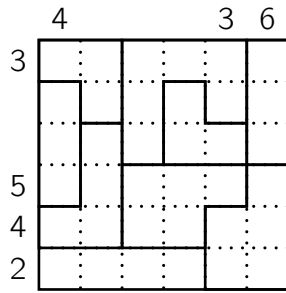

Grille à résoudre

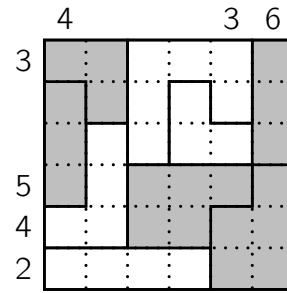

Grille solution

## Tentes — Tents & Trees

Chaque arbre (♣) dans la grille a une tente (Δ) attachée à l'un de ses quatre bords.

Les tentes ne se touchent pas, même pas en diagonale.

Les chiffres marginaux indiquent les nombres des tentes sur les lignes ou colonnes correspondantes.

Exemple

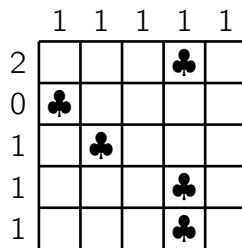

Grille à résoudre

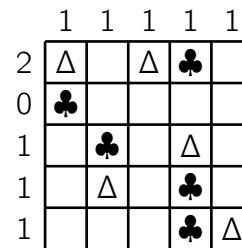

Grille solution

## Tetroid

Il s'agit de remplir la grille avec des tétraminos.

Aucune case noire ne peut être recouverte par un tétramino et toute case blanche doit être recouverte par un tétramino.

Il y a quatre formes de tétraminos (les pièces, composées de quatre carrés, sont réversibles) :

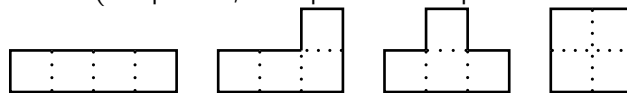

Deux tétraminos de même forme ne peuvent pas avoir un côté commun.

Exemple

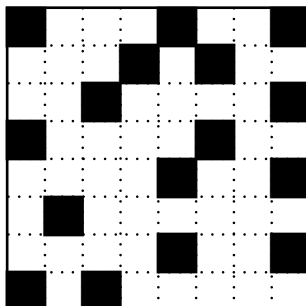

Grille à résoudre

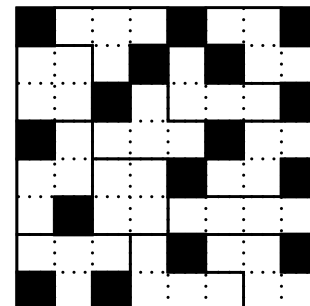

Grille solution



## Thermomètres

Le puzzle constitue une grille carrée qui contient des thermomètres de trois types : pas remplis, partiellement remplis et complètement remplis.

Les chiffres marginaux à gauche et en haut de la grille indiquent le nombre de divisions remplies des thermomètres dans les lignes et colonnes relatives.

Chaque thermomètre est rempli de la base (partie circulaire), vers le haut, cela ne dépend pas de l'orientation du thermomètre.

Exemple

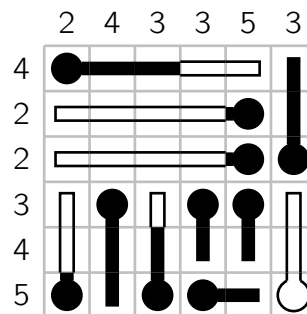
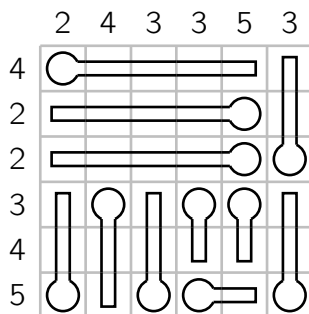

## Toichika

Le but du jeu est de placer des flèches (orientées vers le haut, la gauche, le bas et la droite) dans la grille selon les conditions suivantes :

- chaque région ne contient qu'une seule flèche ;
- les flèches pointent par paires l'une vers l'autre ;
- les flèches en paire doivent être séparées au moins par une région et aucune des deux flèches n'appartient à cette région ;
- il n'y a pas de flèche entre les flèches en paire.

Exemple

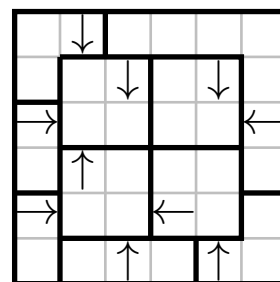
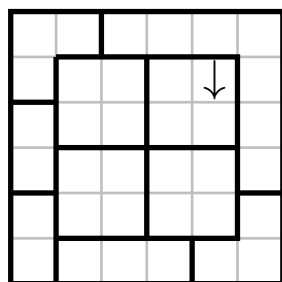

## Tra-vers

Le but du jeu est de retrouver le chemin sachant que :

- on ne passe jamais deux fois dans la même case ;
- l'entrée et la sortie sont indiqués par les flèches ;
- le nombre de cases traversées parmi les voisines (celles ayant un côté commun) est indiquées sur certaines cases ;

- on traverse les cases en entrant par le milieu d'un côté et on ressort par le milieu d'un autre ;
- on ne passe pas par les cases marquées d'un nombre.

Exemple

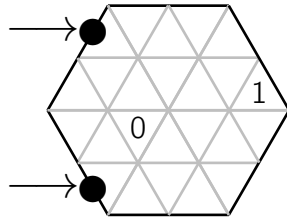

Grille à résoudre

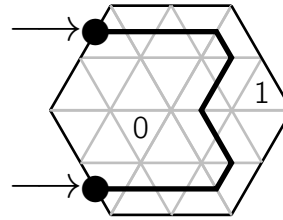

Grille solution

## Trace numbers

Le but du jeu est de tracer autant de lignes brisées dans la grille qu'il y a des cases contenant le nombre 1. Les traits relient les centres des cases et sont horizontaux ou verticaux.

La ligne traverse successivement la case numérotée 1 puis la case numérotée 2 puis la case numérotée 3 et ainsi de suite, le cas échéant.

Chaque case n'est traversée qu'une seule fois.

Exemple

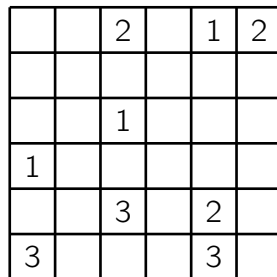

Grille à résoudre

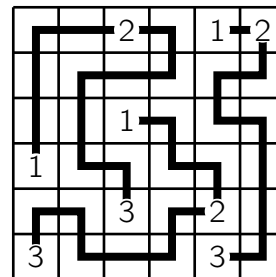

Grille solution

## Tripletts

Le but du jeu est de remplir chacune des cases d'une grille par un symbole (un carré, un disque et un triangle) selon les conditions suivantes :

- dans chaque zone, les trois symboles sont identiques soit tous différents ;
- deux symboles situés de part et d'autre d'un côté séparant deux zones sont différents.

Exemple

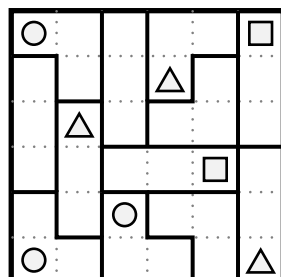

Grille à résoudre

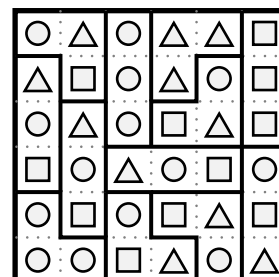

Grille solution

## Voisins — Neighbours

Dans la grille de dimension  $n$ , il faut placer les  $n$  entiers de 1 à  $n$  tels que chaque rangée et colonne contiennent chaque entier une fois et une seule.

De plus, la présence du symbole  $\blacklozenge$  entre deux cases adjacentes signifie que les deux entiers à l'intérieur sont consécutifs et son absence signifie que les deux entiers ne sont pas consécutifs.

*Exemple*

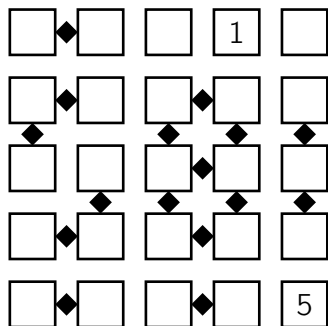

*Grille à résoudre*

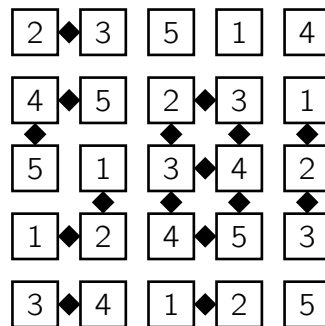

*Grille solution*

## Walls

Le but du jeu est de placer dans toutes les cases vides de la grille, représentant un mur, des plaques décorées d'un trait horizontal ou vertical.

Des plaques juxtaposées permettent d'obtenir une ligne (horizontale ou verticale) composée d'un ou de plusieurs traits.

Le nombre dans une case noire numérotée indique la longueur totale de toutes les lignes finissant aux bords de celle-ci.

L'extrémité d'une ligne n'est pas nécessairement une case noire numérotée; une ligne peut connecter deux cases noires numérotées.

*Exemple*

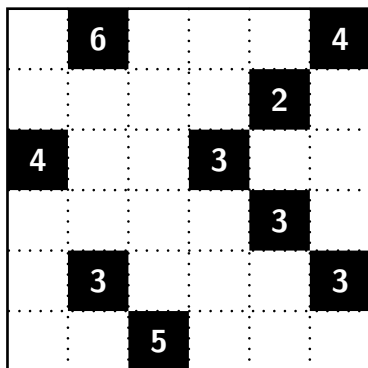

*Grille à résoudre*

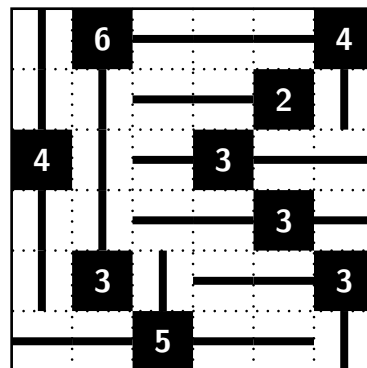

*Grille solution*

## Yakuso

Le but du jeu est de remplir une grille par des nombres selon les conditions suivantes :

- dans une même ligne, les nombres sont soit nuls soit égaux ;

- dans une même ligne, le nombre  $N$  est écrit  $N$  fois ;
- dans une grille de  $L$  lignes, les nombres utilisés sont les nombres de 1 à  $L$ .
- le nombre sous une colonne indique la somme des nombres écrits dans les cases de cette colonne.

Exemple

			1		
				3	
	0		4	0	
5	5				

4 12 10 9

Grille à résoudre

0	0	0	1	0	0
3	3	0	0	3	0
4	0	4	4	0	4
0	0	0	2	2	0
5	5	0	5	5	5

4 12 10 9

Grille solution

## Zehnergitter

Le but du jeu est de remplir la grille avec les conditions suivantes.

- Chacun des dix nombres de 0 à 9 est écrit (une fois et une fois seulement) dans chacune des lignes ;
- deux cases adjacentes verticalement ou en diagonale ne peuvent pas contenir le même nombre ;
- la somme des nombres de chaque colonne est égale au nombre écrit dans la case de la dernière ligne de cette colonne.

Exemple

7		5				8		6	
8	6			7			2	9	5
	7			2	5	9			
			7		1		3		8
	4	9	0	3	7		8		1
29	27	23	25	16	18	23	22	24	18

Grille à résoudre

7	4	5	9	0	2	8	3	6	1
8	6	0	1	7	3	4	2	9	5
0	7	4	8	2	5	9	6	1	3
9	6	5	7	4	1	0	3	2	8
5	4	9	0	3	7	2	8	6	1
29	27	23	25	16	18	23	22	24	18

Grille solution

## Zipline

Le but du jeu est d'écrire dans les cases blanches d'une grille les nombres allant de 1 au nombre total de cases blanches (24, dans l'exemple ci-dessous), chaque nombre étant écrit une fois et une seule.

Le nombre indiqué dans une case noire indique la somme des nombres inscrits dans les cases blanches qui touchent cette case par un côté.

Un nombre pair  $N$  doit être placé dans la même ligne ou la même colonne que le nombre impair  $N - 1$  et un nombre impair  $M$  doit être placé dans la même diagonale que le nombre pair  $M - 1$ .

Exemple

<b>37</b>			<b>10</b>	<b>2</b>	<b>17</b>
			<b>32</b>		
<b>18</b>	<b>25</b>				
<b>41</b>			<b>31</b>		
	<b>81</b>			<b>43</b>	
				<b>20</b>	

*Grille à résoudre*

<b>37</b>	19	10	<b>10</b>	<b>2</b>	<b>17</b>
18	1	23	<b>32</b>	2	17
<b>18</b>	<b>25</b>	4	7	11	12
<b>41</b>	20	3	<b>31</b>	13	14
21	<b>81</b>	24	8	<b>43</b>	22
6	16	9	15	<b>20</b>	5

*Grille solution*

## Zwischenknick

Le but du jeu est de dessiner une boucle fermée qui passe par chaque case de la grille une fois seulement. La boucle ne doit pas se croiser et elle est constituée de segments horizontaux et verticaux passant par les centres des cases.

La boucle doit tourner de 90° à chaque fois qu'elle rencontre une perle noire et elle doit tourner de 90° entre deux perles noires exactement une fois.

*Exemple*

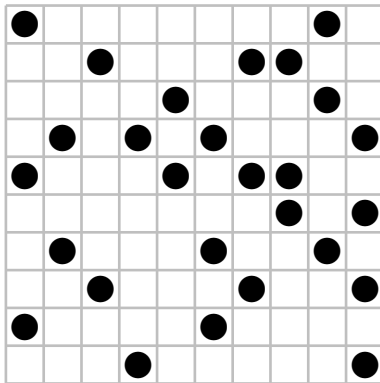

*Grille à résoudre*

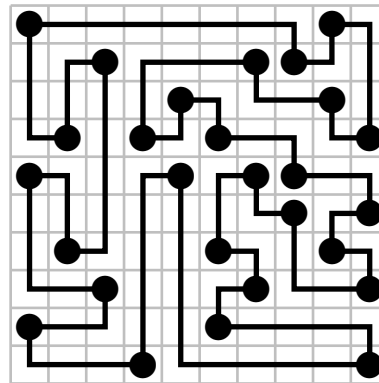

*Grille solution*

# ABC End view

## Niveau 1

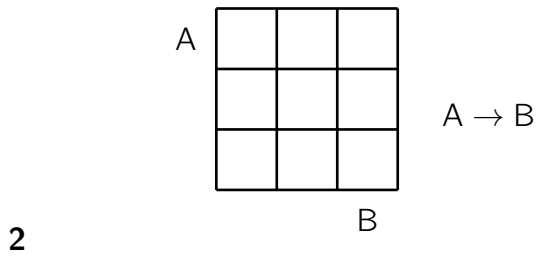
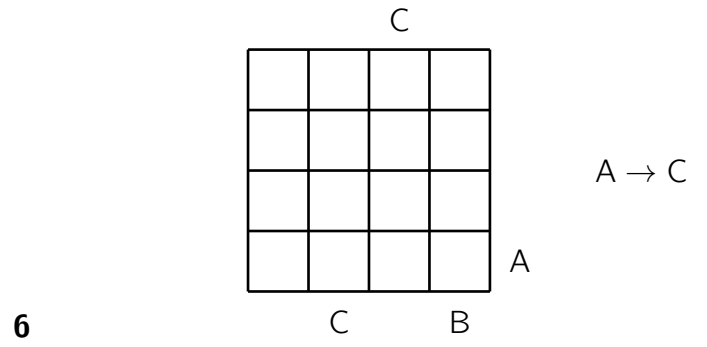
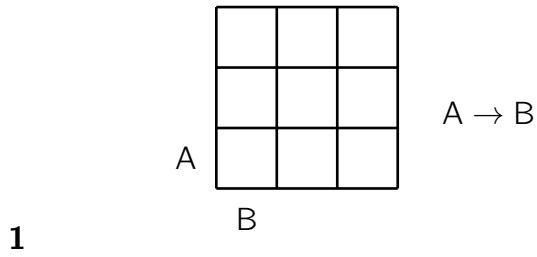

## Niveau 3

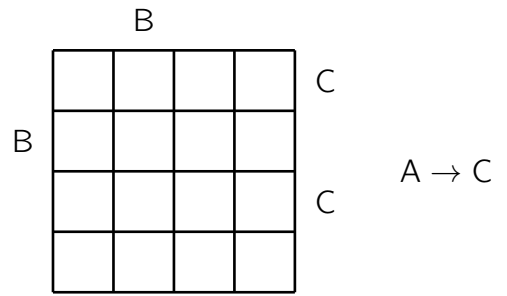

## Niveau 2

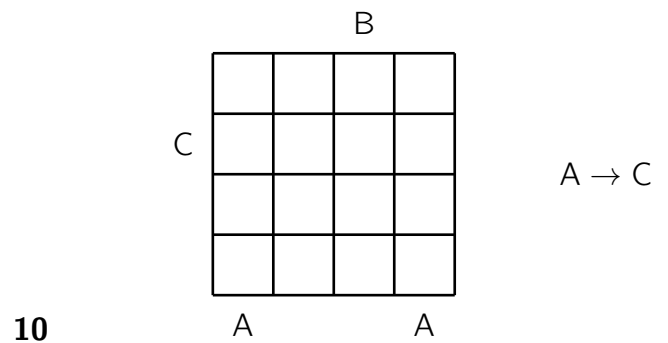
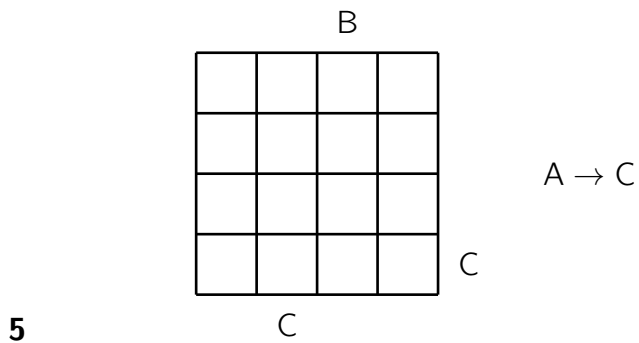
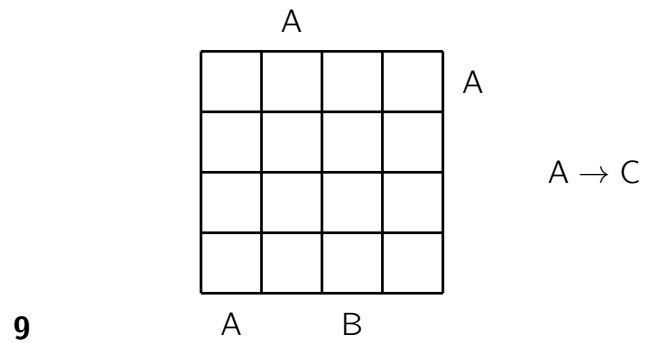
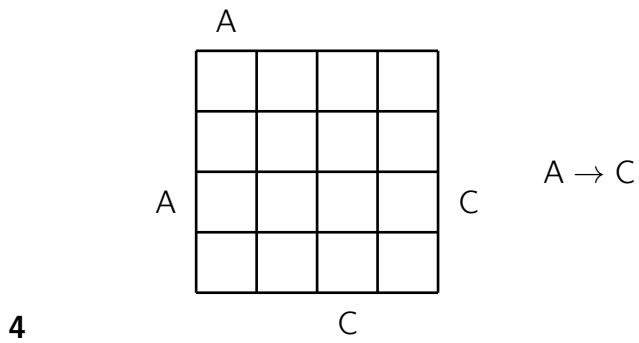
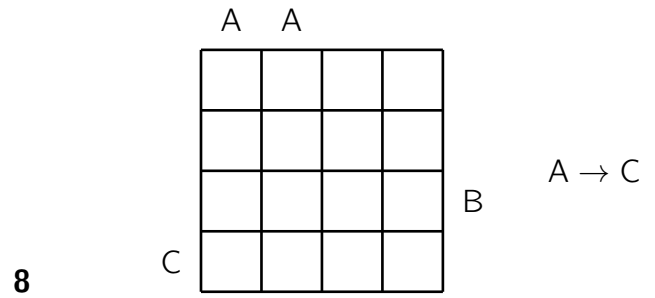
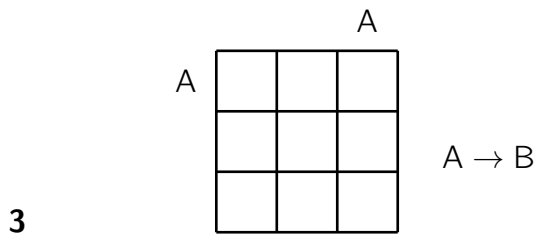

### Niveau 4

11

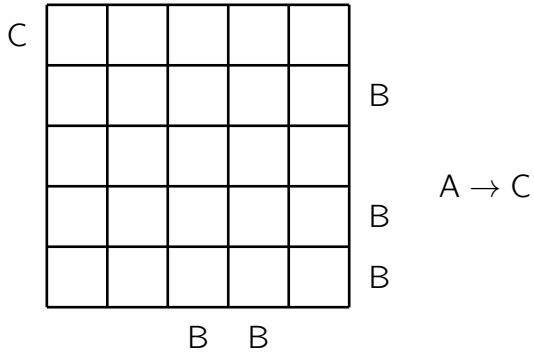

12

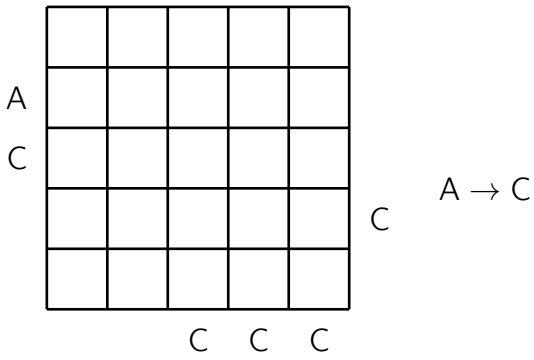

13

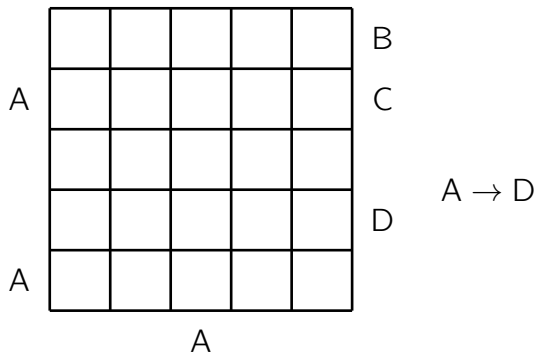

14

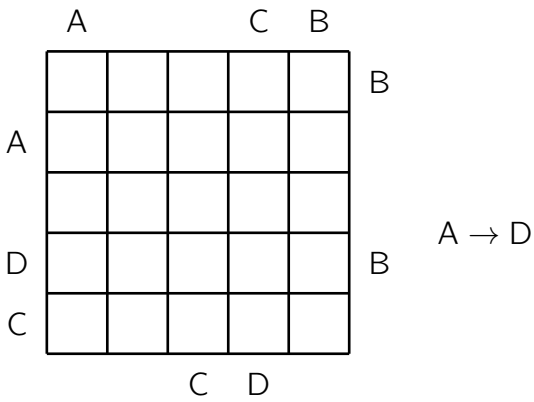

### Niveau 5

15

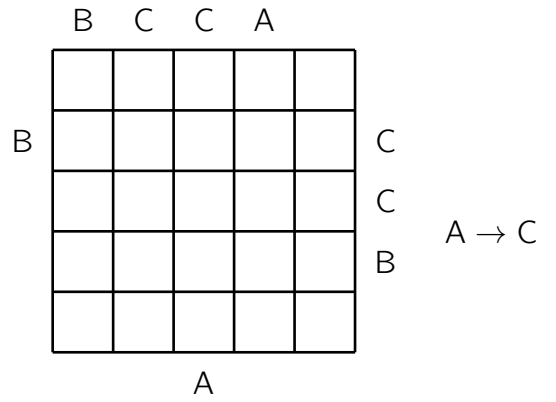

16

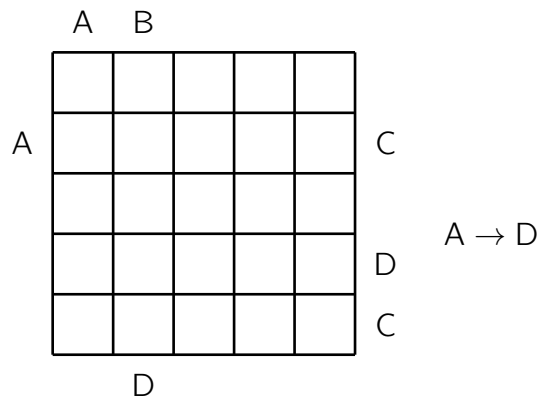

17

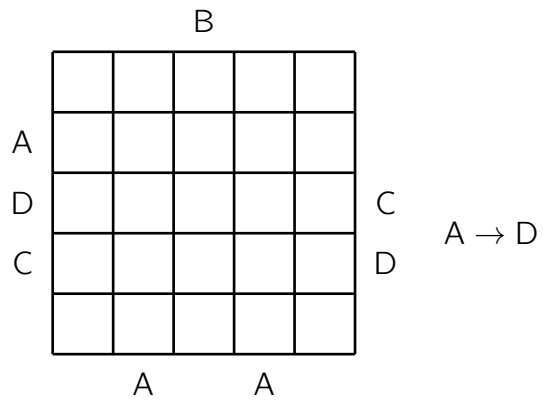

18

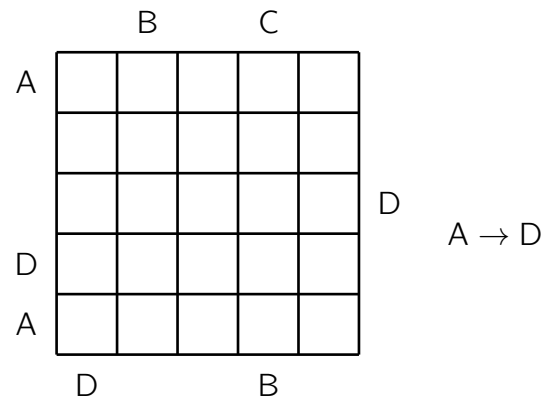

# ABC Kombi

## Niveau 1

**1**

<b>A</b>	1	2	1	1
<b>B</b>	1	1	2	1
<b>A B C</b>	2	1	1	2

**2**

<b>A</b>	2	2	2	2
<b>B</b>	1	0	2	0
<b>A B C</b>	1	2	0	2

**3**

<b>A</b>	1	2	2	0
<b>B</b>	1	2	0	2
<b>A B C</b>	2	0	2	2

**4**

<b>A</b>	2	0	2	2
<b>B</b>	0	2	2	2
<b>A B C</b>	2	0	2	2

<b>A</b>	2	1	1	1
----------	---	---	---	---

**5**

<b>A</b>	1	1	2	1
<b>B</b>	1	2	2	2
<b>A B C</b>	2	1	0	1

<b>A</b>	1	2	1	1
<b>B</b>	1	1	2	2
<b>A B C</b>	1	2	1	0

**6**

<b>A</b>	2	1	2	0
<b>B</b>	1	1	1	2
<b>A B C</b>	1	2	1	2

<b>A</b>	2	0	2	1
<b>B</b>	1	2	1	2
<b>A B C</b>	1	1	2	1

## Niveau 2

**7**

<b>A</b>	0	1	1	1
<b>B</b>	2	1	2	2
<b>A B C</b>	2	2	1	1

<b>A</b>	1	2	1	1
<b>B</b>	1	2	1	2
<b>A B C</b>	1	1	2	2



### Niveau 3

8

	<b>A</b>	2	1	1	2																	
	<b>B</b>	0	1	2	0																	
	<b>C</b>	2	1	0	1																	
<b>A</b>	<b>B</b>	<b>C</b>	<b>D</b>	0	1	1	1															
2	1	1	0	<table border="1" style="width: 100%; height: 100%; border-collapse: collapse;"> <tr><td> </td><td> </td><td> </td><td> </td></tr> <tr><td> </td><td> </td><td> </td><td> </td></tr> <tr><td> </td><td> </td><td> </td><td> </td></tr> <tr><td> </td><td> </td><td> </td><td> </td></tr> </table>																		
1	1	1	1																			
1	0	1	2																			
2	1	1	0																			

11

	<b>A</b>	2	1	2	1	1	1																									
	<b>B</b>	0	1	1	1	1	1																									
	<b>C</b>	2	1	1	0	2	1																									
<b>A</b>	<b>B</b>	<b>C</b>	<b>D</b>	0	1	0	2	0	1																							
3	1	0	2	<table border="1" style="width: 100%; height: 100%; border-collapse: collapse;"> <tr><td> </td><td> </td><td> </td><td> </td><td> </td><td> </td></tr> <tr><td> </td><td> </td><td> </td><td> </td><td> </td><td> </td></tr> <tr><td> </td><td> </td><td> </td><td> </td><td> </td><td> </td></tr> <tr><td> </td><td> </td><td> </td><td> </td><td> </td><td> </td></tr> </table>																												
2	1	2	1																													
3	1	2	0																													
0	2	3	1																													

9

	<b>A</b>	1	1	2	1																	
	<b>B</b>	1	1	1	1																	
	<b>C</b>	1	1	0	1																	
<b>A</b>	<b>B</b>	<b>C</b>	<b>D</b>	1	1	1	1															
2	2	0	0	<table border="1" style="width: 100%; height: 100%; border-collapse: collapse;"> <tr><td> </td><td> </td><td> </td><td> </td></tr> <tr><td> </td><td> </td><td> </td><td> </td></tr> <tr><td> </td><td> </td><td> </td><td> </td></tr> <tr><td> </td><td> </td><td> </td><td> </td></tr> </table>																		
0	1	2	1																			
2	0	0	2																			
1	1	1	1																			

12

	<b>A</b>	0	2	0	1	0	2																									
	<b>B</b>	2	1	1	1	1	0																									
	<b>C</b>	1	0	2	1	2	1																									
<b>A</b>	<b>B</b>	<b>C</b>	<b>D</b>	1	1	1	1	1	1																							
2	1	2	1	<table border="1" style="width: 100%; height: 100%; border-collapse: collapse;"> <tr><td> </td><td> </td><td> </td><td> </td><td> </td><td> </td></tr> <tr><td> </td><td> </td><td> </td><td> </td><td> </td><td> </td></tr> <tr><td> </td><td> </td><td> </td><td> </td><td> </td><td> </td></tr> <tr><td> </td><td> </td><td> </td><td> </td><td> </td><td> </td></tr> </table>																												
1	2	0	3																													
0	2	3	1																													
2	1	2	1																													

10

	<b>A</b>	1	2	1	0	1	2																									
	<b>B</b>	1	1	0	1	1	1																									
	<b>C</b>	1	0	1	2	0	0																									
<b>A</b>	<b>B</b>	<b>C</b>	<b>D</b>	1	1	2	1	2	1																							
2	1	1	2	<table border="1" style="width: 100%; height: 100%; border-collapse: collapse;"> <tr><td> </td><td> </td><td> </td><td> </td><td> </td><td> </td></tr> <tr><td> </td><td> </td><td> </td><td> </td><td> </td><td> </td></tr> <tr><td> </td><td> </td><td> </td><td> </td><td> </td><td> </td></tr> <tr><td> </td><td> </td><td> </td><td> </td><td> </td><td> </td></tr> </table>																												
3	3	0	0																													
2	0	1	3																													
0	1	2	3																													

13

	<b>A</b>	1	1	1	2	1																				
	<b>B</b>	1	2	2	1	1																				
	<b>C</b>	2	0	2	1	1																				
<b>A</b>	<b>B</b>	<b>C</b>	<b>D</b>	1	2	0	1	2																		
0	1	2	2	<table border="1" style="width: 100%; height: 100%; border-collapse: collapse;"> <tr><td> </td><td> </td><td> </td><td> </td><td> </td></tr> <tr><td> </td><td> </td><td> </td><td> </td><td> </td></tr> <tr><td> </td><td> </td><td> </td><td> </td><td> </td></tr> <tr><td> </td><td> </td><td> </td><td> </td><td> </td></tr> </table>																						
1	2	1	1																							
3	0	0	2																							
2	2	1	0																							
0	2	2	1																							

# ABC Path — Chemin ABC

1

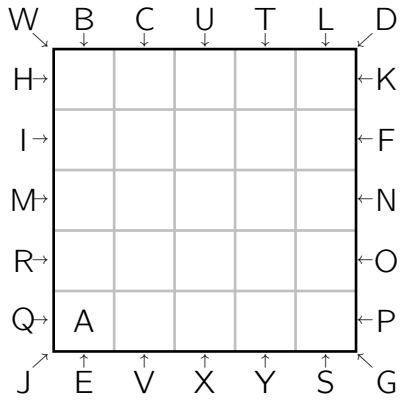

2

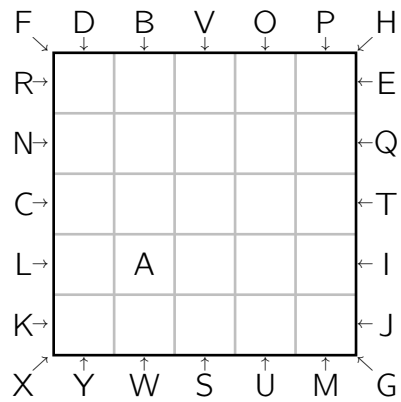

3

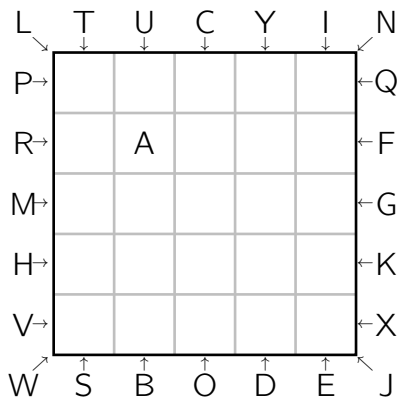

4

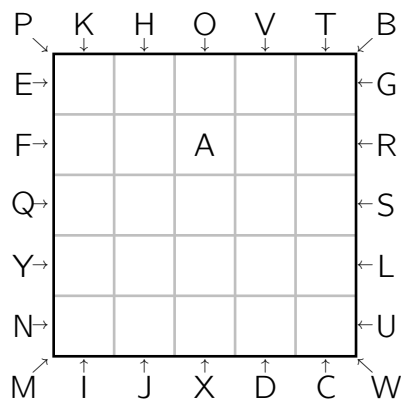

5

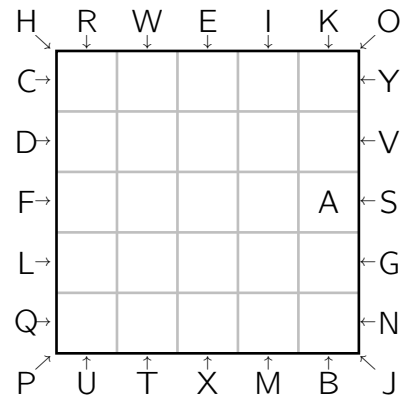

6

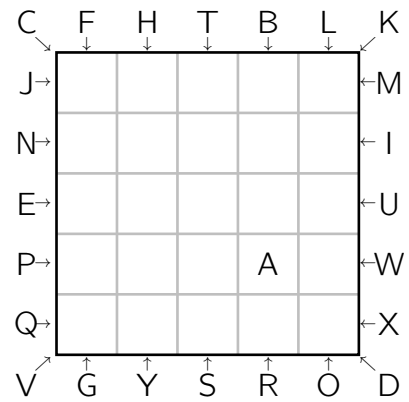

7

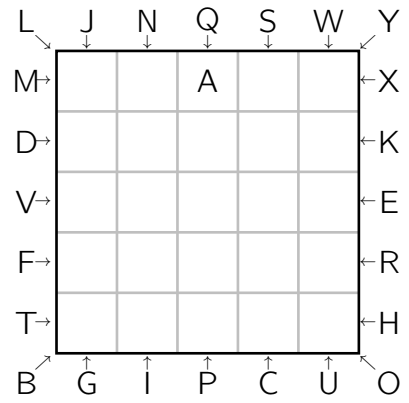

8

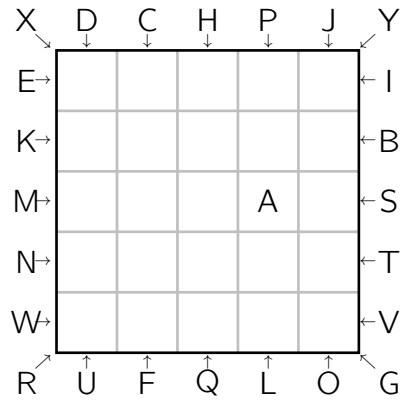

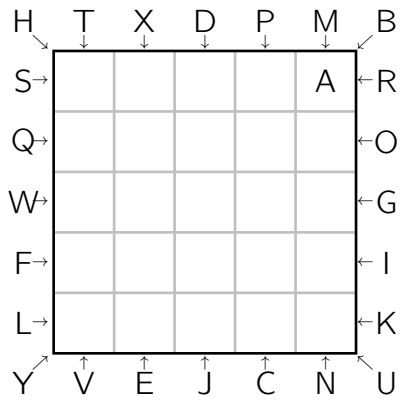

9

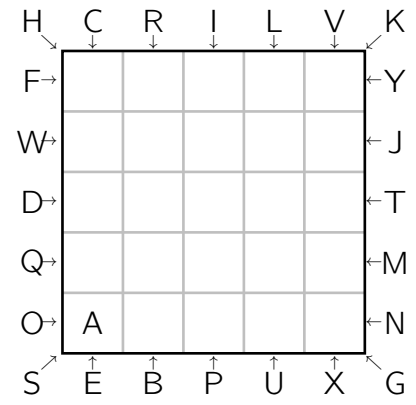

13

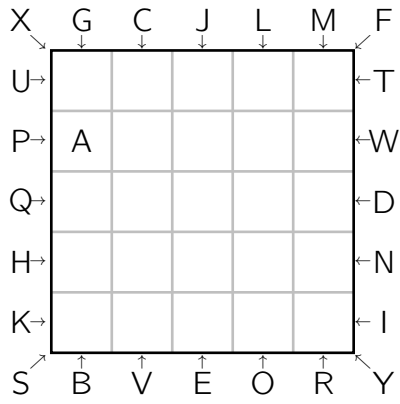

10

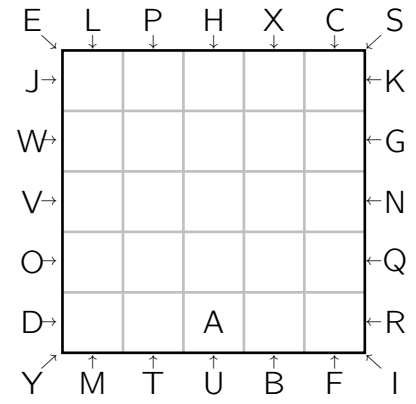

14

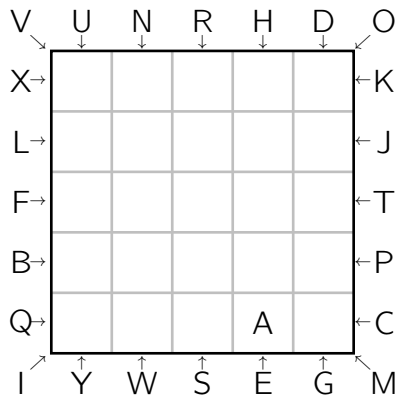

11

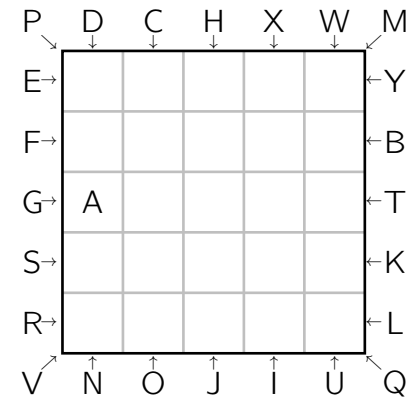

15

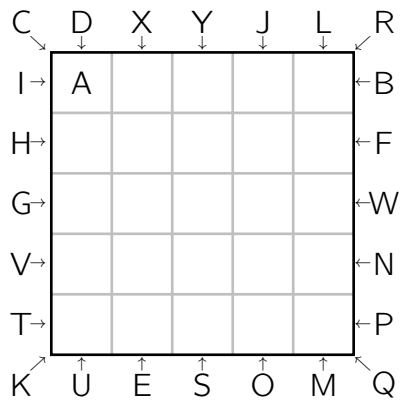

12

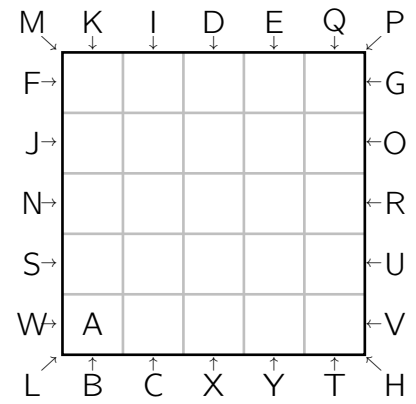

16

# Akari — Light up

## Niveau 1

1

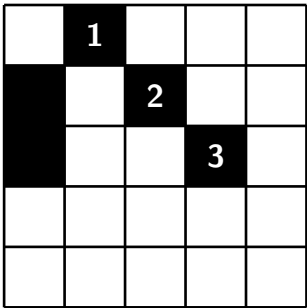

2

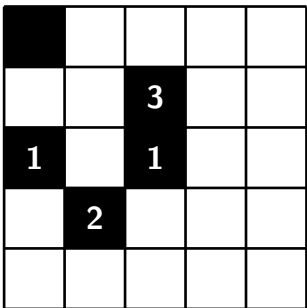

3

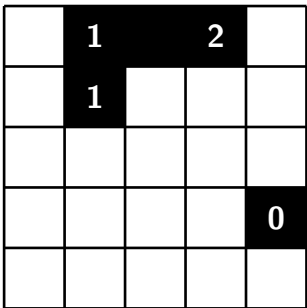

4

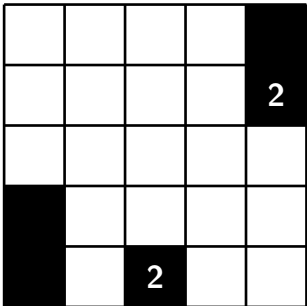

5

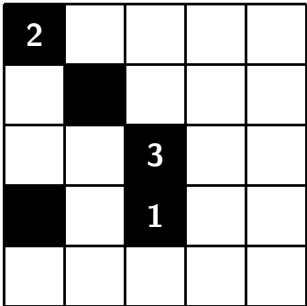

6

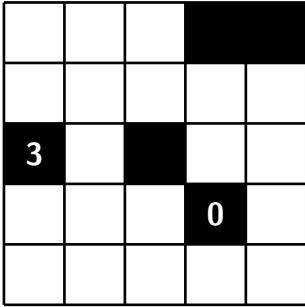

7

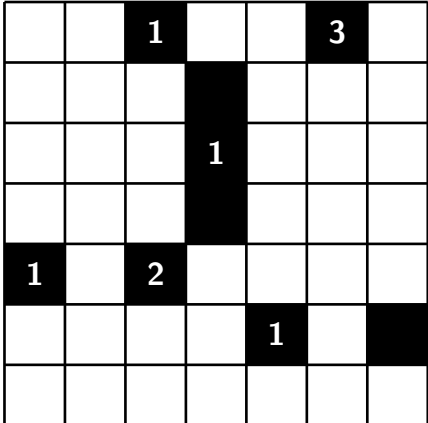

8

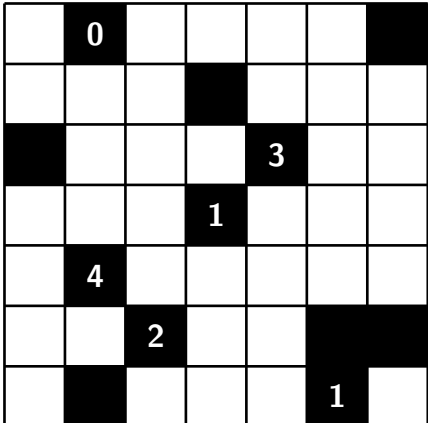

9

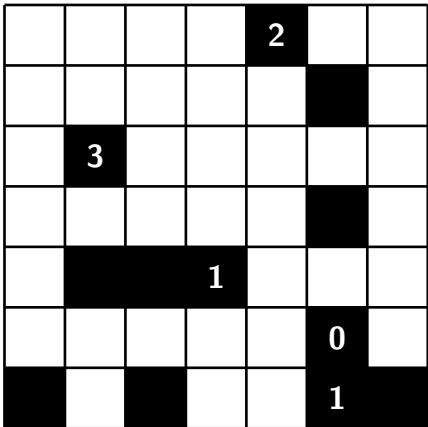

## Niveau 2

10

			0	
0				
1		1		
				0

11

				1
1				
		0		
1				
			1	

12

		3		
			3	

13

			1			1
		0				
2						
1				0		
			2			

14

				3		
2				2	0	
			2			
	0			1		

## Niveau 3

15

1			1	
	2			2

16

	2			
				2
	0			
			1	

17

	0		0	
	2		2	

18

0					
			0		
			1		2
				2	
0			0	1	
1					
				2	

19

0					
		1	2		
	1		0		
					0
		2			

# Anglers

## Niveau 1

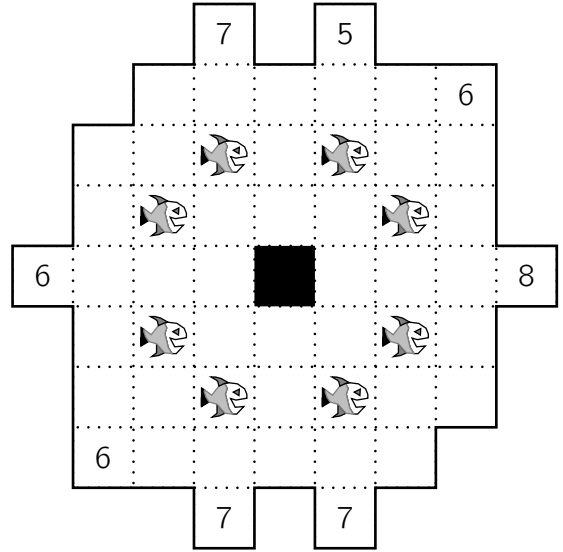
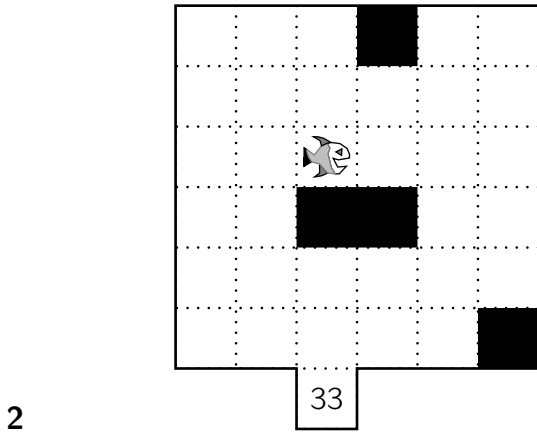
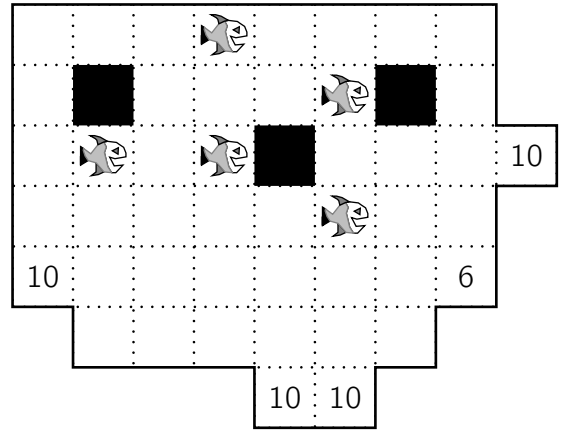
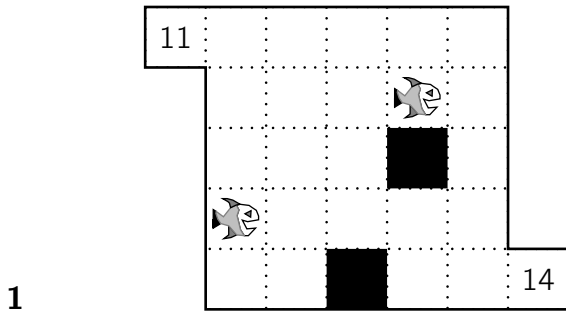

## Niveau 2

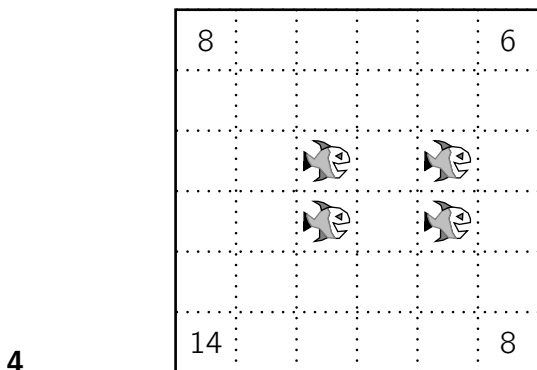
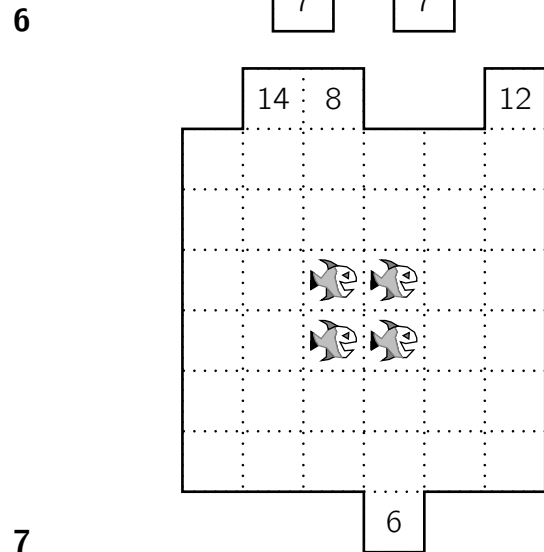
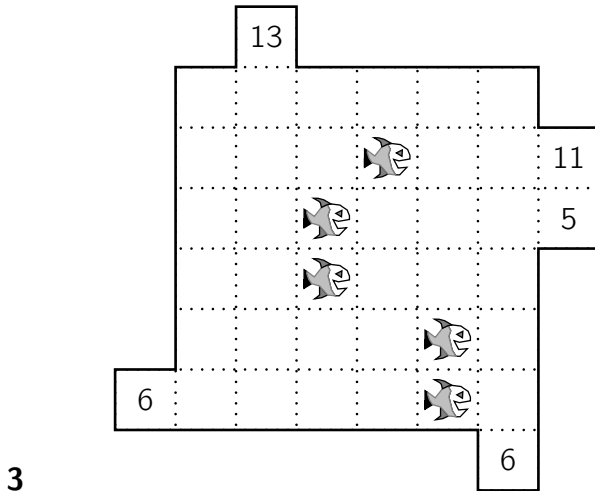

### Niveau 3

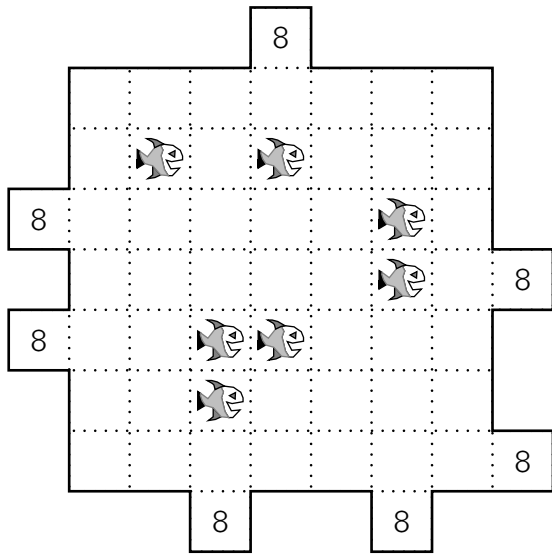

8

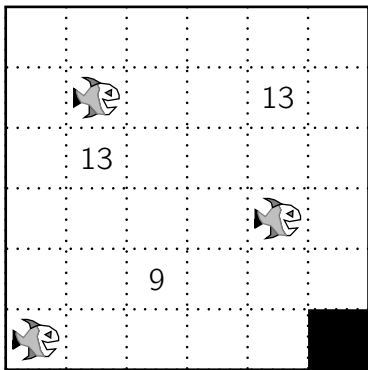

9

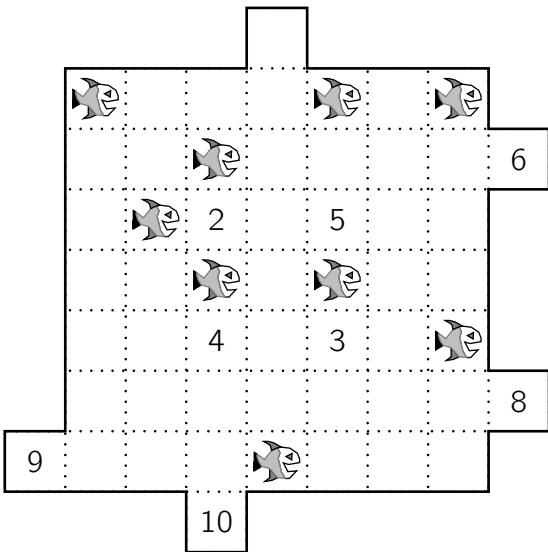

10

### Niveau 4

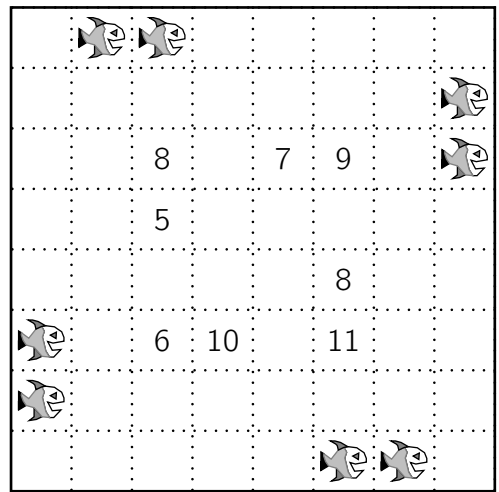

11

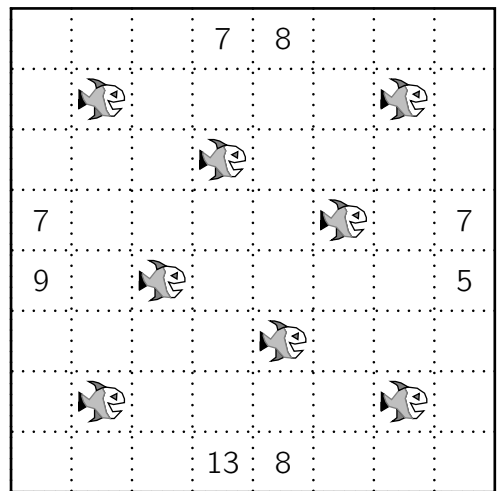

12

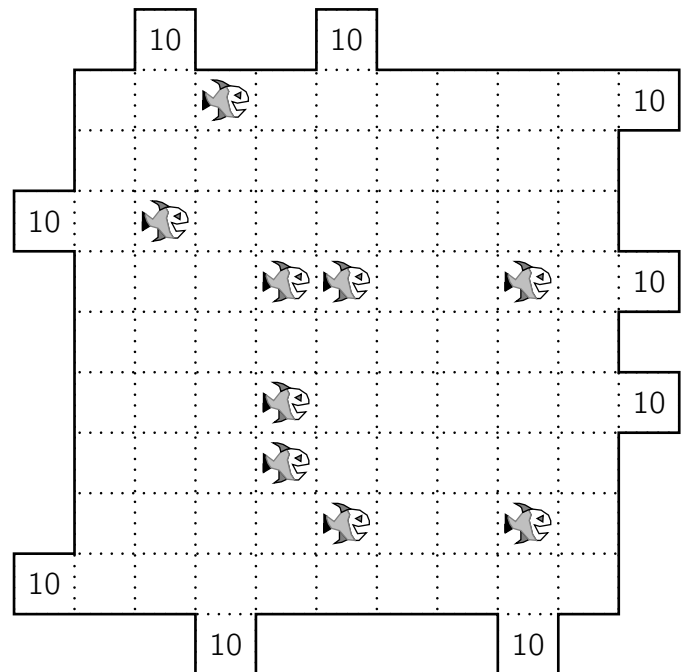

13

# Aquarium – Waterfun

## Niveau 1

1

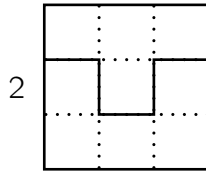

2

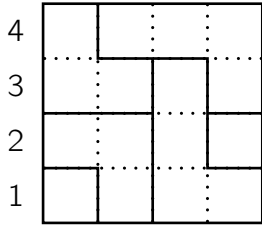

3

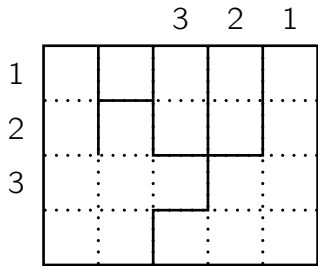

4

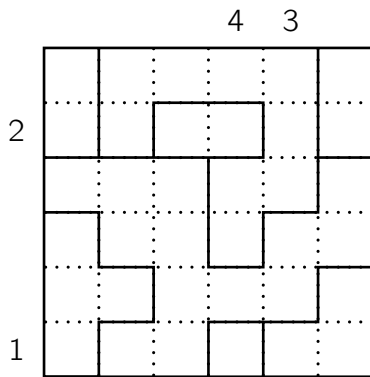

## Niveau 2

5

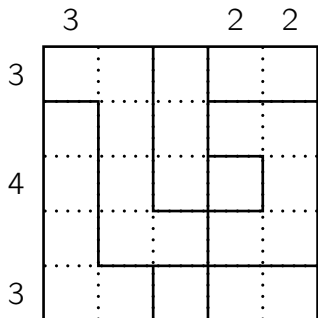

6

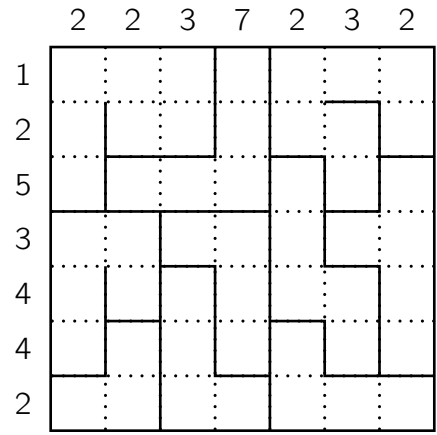

7

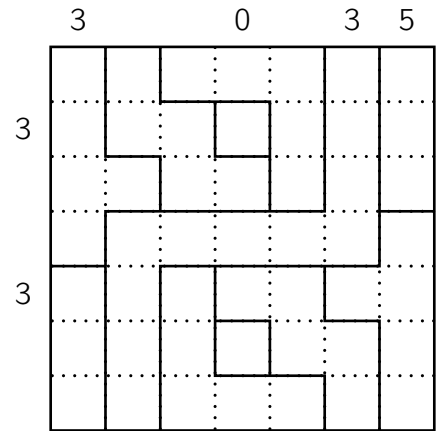

8

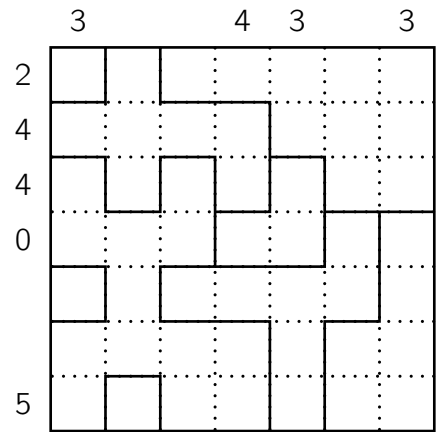

9

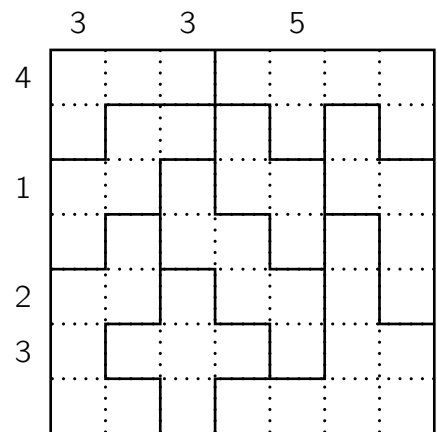



10

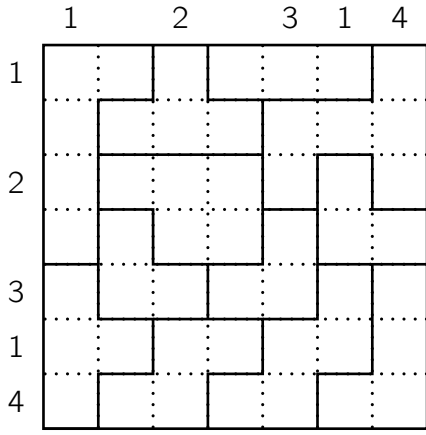

11

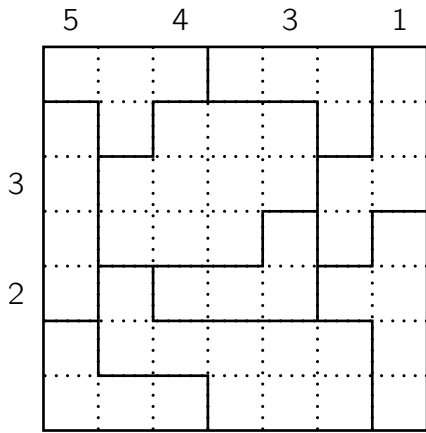

12

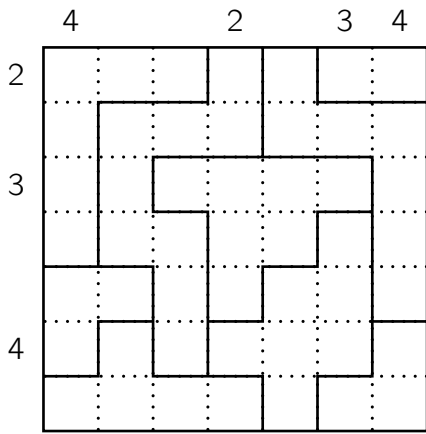

13

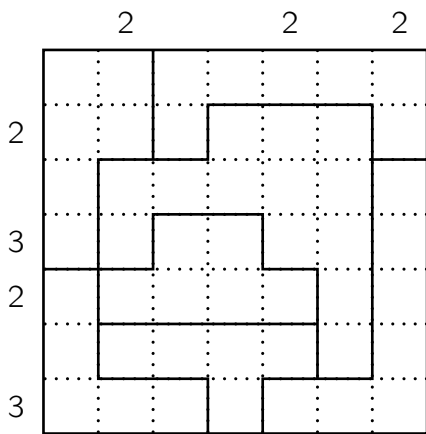

14

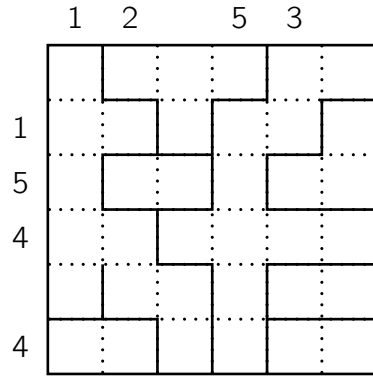

15

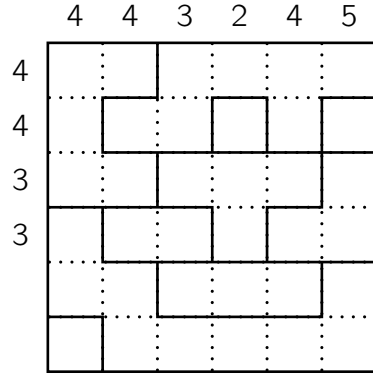

Niveau 3

16

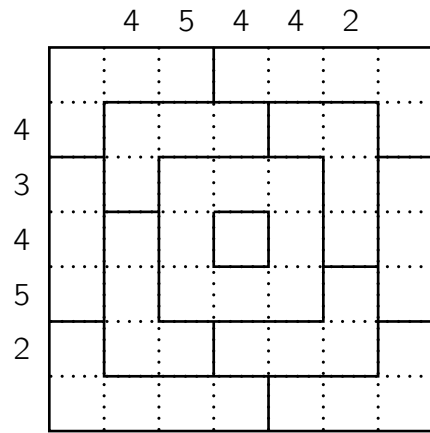

17

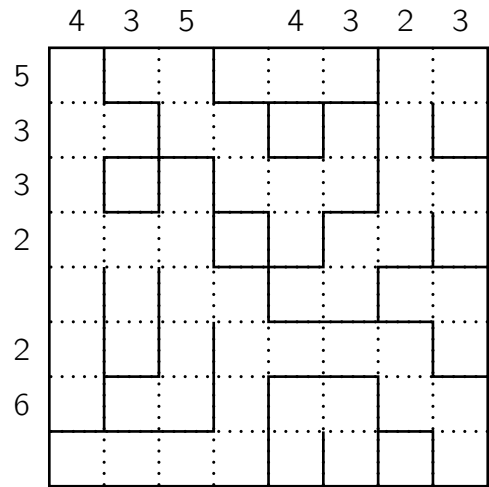

# Arukone — Numberlink

## Niveau 1

1

		2	1	3
		3		
				1
				2

2

1				4
2				3
				4
				3
2	1			

3

1	4	1		3
	2	4		
		2		
				3

4

			1	
3			2	
1			3	2

## Niveau 2

5

			1	2
	2			
		3		
			1	
	3			

6

			2	1
	3	4		
		3		
	1	2		
4				

7

2			3	1
	1			
	2	3		

8

1				
			4	
		4	2	3
	1		3	2

9

1	4			
		2	3	
	1			
4			3	2

10

1		2		
2				
		3		
	3	1		

11

		3	1
	2		
		3	
1	2		

16

		2	
	1	3	
		1	
		3	
2			

12

4	1		4	3
	2			
		1		
		2		
				3

17

1	3			
			1	
		2		
		3		
				2

Niveau 3

Niveau 4

13

			2
	2		
	3		
1			1
3			

18

		2	
	2		1
		3	
			1
	3		

14

			1
	1		
	3		
		2	
2	3		

19

1			3
	2		1
3			2

15

			1
		3	
		2	1
2			3

20

	2		3
2	1		3
			1

# Bataille navale — Battleship

## Niveau 1

1

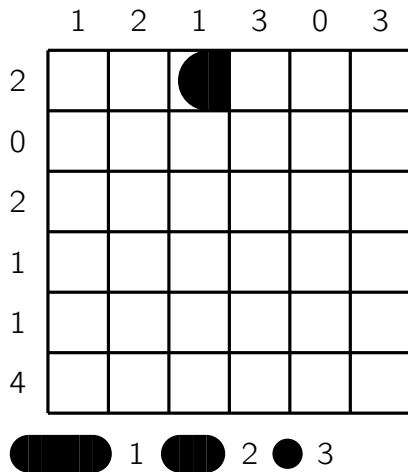

2

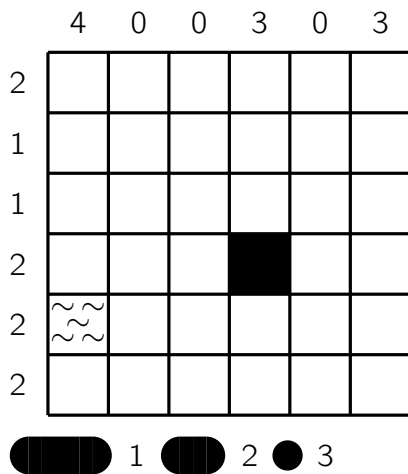

3

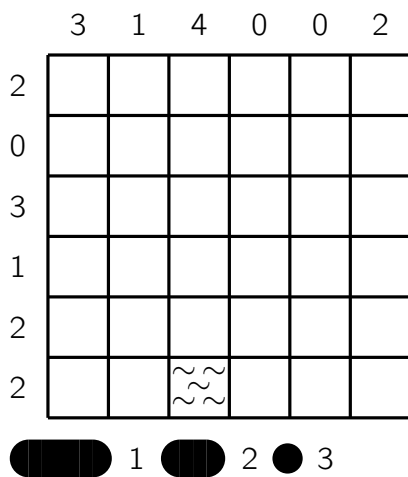

4

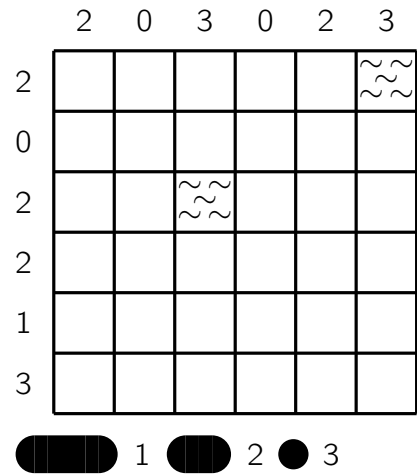

5

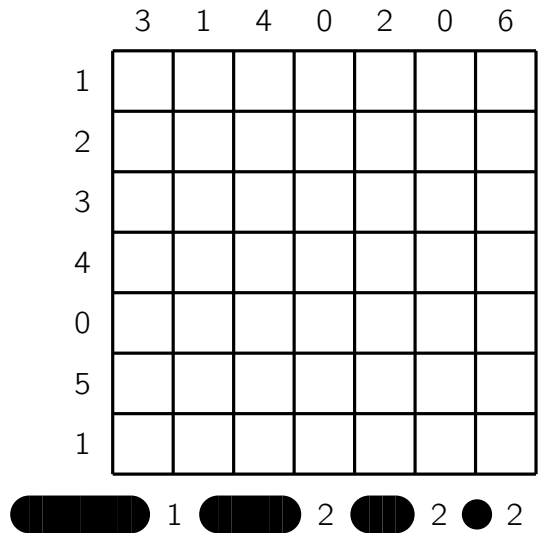

6

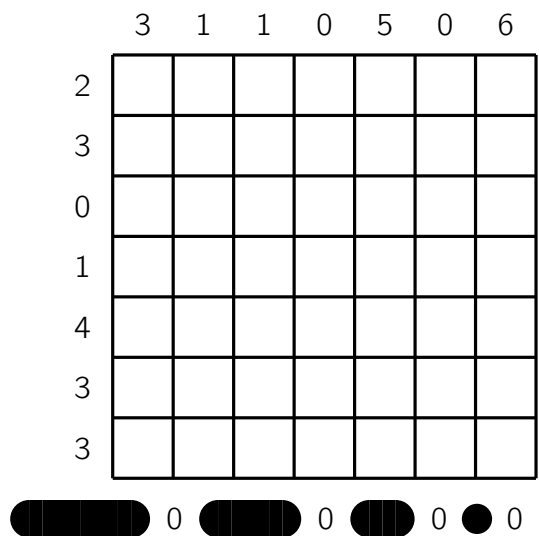

## Niveau 2

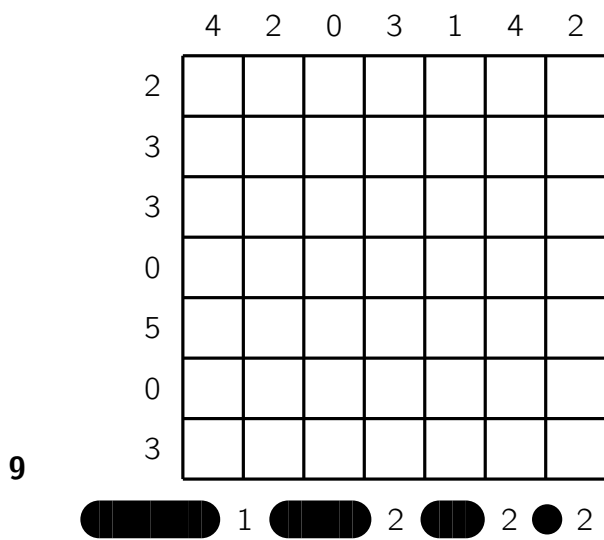
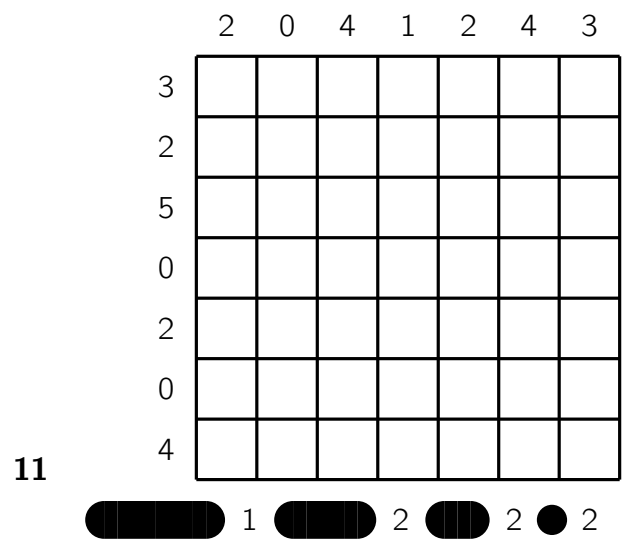
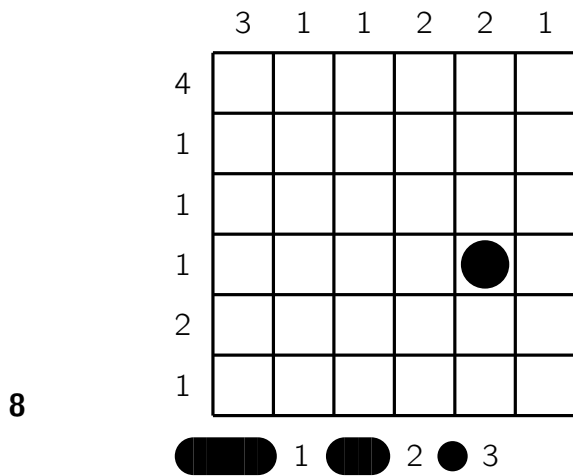
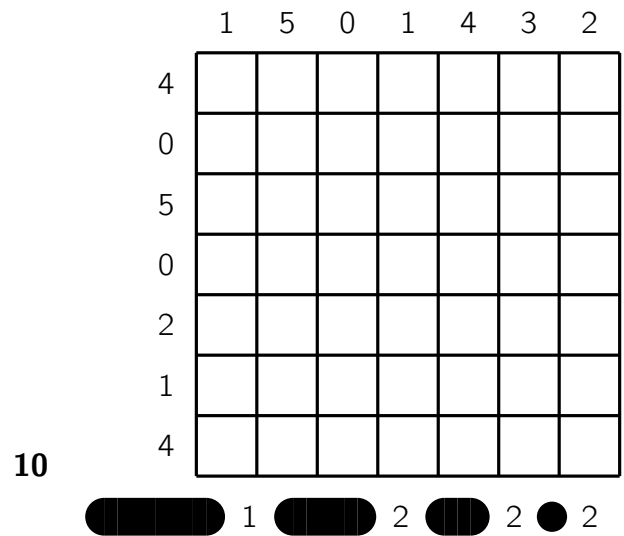
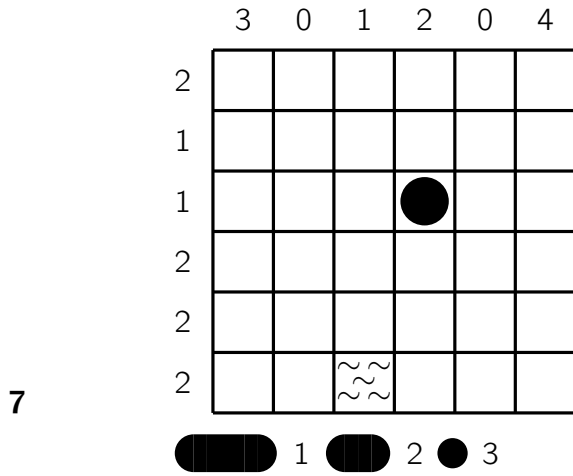

## Niveau 3

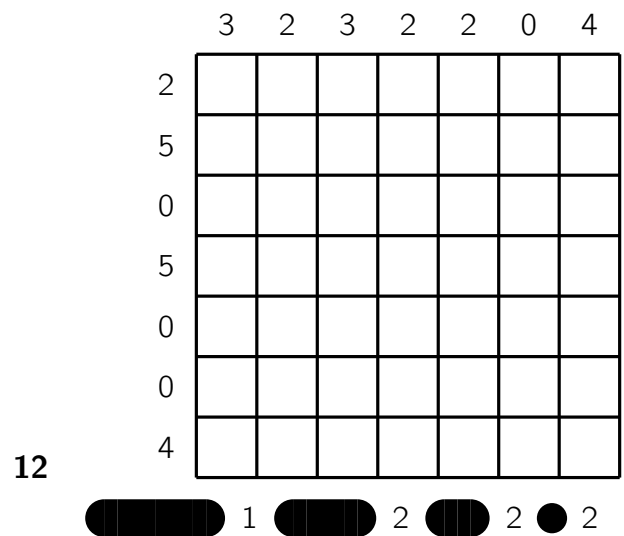

# Binero

## Niveau 1

1

	1		
1	1		
			0

2

			0
		1	
0			0

3

0		0	
1			1
	0		

4

				1	1
	0	0			0
1					
			1		
				0	
			1		

5

		0	0		
1					1
			0	0	
				0	
					1

6

1	1			1	0		0
0		0		0	1		
				1	1		
1	1					0	
	0	0		1			

## Niveau 2

7

			0		0
	0			1	
					0
1					
		0		1	1
	1				

8

		1			
		1	1		0
0			0		
				1	
1			0		

9

			1		
		0			0
0	1				0
	1				
			1		
		0			

10

			0		0
	1			1	
		0			
			1		
0		0			
0		0			

14

	1			1	
	0			1	
			0		
		1			1
			0		
					0

11

1		0	0			0	
					1		
							1
	1			1			1
			0		0		
	1				0		
	1						0
			0				

15

	1			1	
	0			1	
			0		
		1			1
			0		
					0

12

	1			1		1	
				0			
	0	0					0
		1	1				
					1		1
				1	1		
0		0					
0							

16

						0	
			1			0	
		1	1				1
		1			1	0	
			1				0
		0					
							0
	0		1	1			

Niveau 3

13

			0		0
	0		0	0	
				0	
			0		0
		1			
1					

Niveau 4

17

			1		1
0			1		
					1
		0		0	
		0			0

# Briques

## Niveau 1

1

2		6		
		1	3	4
		3	4	
6	5	4		3
4			5	6
			6	

2

	1			6	
1		3		4	
				5	
			6		
		6	5	1	2
			3		

3

1	6			4	
	5		4		
			1	5	
4					
2		5	3		1

4

	4			3	
		3		1	4
		1			6
			3	2	
	3			4	5
2					

5

1	6				
		2		4	
3			2		5
				3	
2			4		
5					

6

	5		2		
		6	1		
1				5	2
6		5			3
			3		
		2			

7

					3
	4			1	
1	2	4			
4			2		
					1
		5			4

## Niveau 2

8

		2			
		3			
	1			5	
6	3			1	5
		5			
		1		3	6



9

				6
4	5		2	1
				4
5	4			
	2			
	1		2	3

14

	2	3		
1		6		
6			1	
	6	1	2	5
	1			
	4		1	

**Niveau 3**

10

			5	
		3		5
5	2		1	3
4	5	6		
2		5		3

15

			5	3
6	5			2
	2		6	
		1	4	6
	4		2	

11

				1	
	4	6	5	2	
		2		4	
		1	4	3	6
	6			2	

16

	5			6
				5
	3	2		
	1			2
			2	
1		5	3	

12

1				3
		4		1
4			3	5
6	1			
		6		3

17

				4
				1
1		2	3	
3				4
		1	6	3
				5

13

			5	
2	1			5
4				2
	5			
5	6		4	
			5	6

# Burroku

## Niveau 1

1

B	D	B	A
C	C	C	A
D	D	B	A
A	D	C	B

2

B	C	D	D
A	B	D	B
A	C	C	A
A	C	B	D

3

C	A	D	D
C	B	C	A
A	D	D	B
B	C	B	A

4

A	B	C	B
C	D	D	A
B	D	B	A
D	A	C	C

5

A	C	B	D
B	D	D	A
C	D	B	C
B	A	A	C

6

C	C	B	A
D	B	A	D
C	D	A	D
B	C	B	A

## Niveau 2

7

D	A	D	A
D	C	B	C
C	B	A	B
D	C	B	A

8

A	D	B	C
D	B	A	B
A	A	D	C
C	D	B	C

## Niveau 3

9

B	E	B	A	D	C
D	E	E	C	F	E
C	A	A	F	B	C
A	C	F	D	A	F
B	F	D	E	D	D
B	A	E	F	C	B

10

B	B	F	C	B	F
C	E	D	A	E	C
D	F	A	C	F	D
F	E	A	F	A	D
D	C	A	C	D	E
B	E	B	E	A	B

11

B	D	C	A	D	B
F	A	F	F	E	B
E	F	E	D	E	C
C	E	C	A	F	D
B	A	D	D	F	C
A	C	E	B	B	A

### Niveau 4

12

B	C	D	F	D	●	B
B	E	F	E	C	E	
F	D	A	●	A	A	B
C	●	C	F	C	E	
B	E	F	A	D	●	A
F	C	D	D	E	B	

13

E	D	A	A	B	A	
D	C	F	B	C	●	B
E	●	E	B	C	E	D
F	B	C	F	D	F	
A	F	A	D	E	C	
B	F	A	●	E	C	D

14

E	D	E	F	A	B	
D	C	E	B	F	●	F
A	F	B	C	A	A	●
A	B	C	F	D	E	
B	C	E	D	E	C	
A	B	●	D	F	C	D

15

C	F	E	B	●	D	A
D	F	E	F	D	●	A
E	B	E	●	A	B	C
D	F	C	B	E	D	
C	B	A	B	D	F	
E	●	A	C	F	A	C

16

A	C	A	D	F	●	B
C	E	F	D	C	D	
A	B	A	●	B	F	
D	●	D	C	E	E	C
F	C	F	D	E	●	A
E	B	E	F	B	A	

17

B	●	F	D	E	E	A	E	G
B	A	F	H	D	C	D	G	
E	H	A	B	G	F	H	F	
F	G	B	D	E	●	H	E	
G	C	A	C	G	C	H	B	
H	C	H	H	B	●	F	F	C
D	A	E	A	E	D	A	D	
G	F	●	C	C	B	G	D	A

18

E	●	C	H	A	E	F	C	C	
D	G	G	D	E	H	B	G		
H	B	●	F	G	E	F	D	B	
F	H	A	D	●	C	H	B	A	
C	C	B	G	B	D	F	A		
F	D	H	A	E	A	●	G	E	
A	●	G	D	E	H	D	C	H	
B	B	●	F	E	A	●	G	F	C

19

E	D	H	F	C	F	A	B		
●	C	G	B	H	C	D	●	G	B
H	G	●	F	A	B	H	D	●	F
A	D	G	D	G	●	A	E	E	
E	E	E	●	C	B	E	H	A	●
F	H	F	H	D	●	A	D	G	
C	B	D	B	●	F	G	C	F	
C	G	B	A	A	E	H	C		

# Catwalk

## Niveau 1

4 

3

4

3

1

4 

3 1 6 3 5 1

1

4 

3

2

2

3

4 

2 2 2 5 4 3

2

6

5 

2 

5

2 4 2 4 5 5

3

3 

3

4

3

5 

3

2 5 6 1 4 3

4

5

2

4 

5

3

4 

2

3 2 4 5 6 2 3

5

2 

3

2

5

4

5 

2 5 5 4 2 3

6

2 

2 

5

5

3 

3 

4

7

2 

6 

2

6

6

3 

3 

5

3 4 7 2 6 3 5

8

## Niveau 2

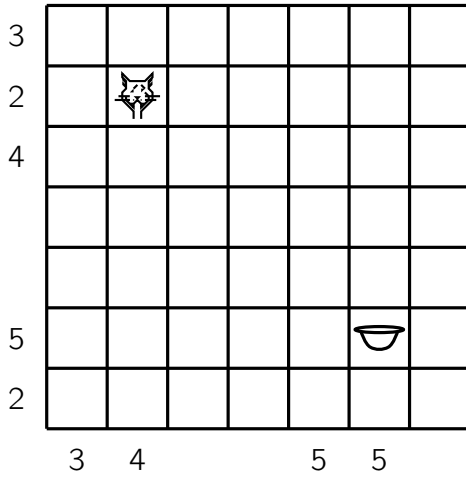

9

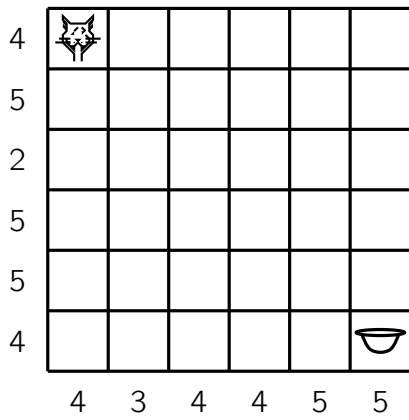

10

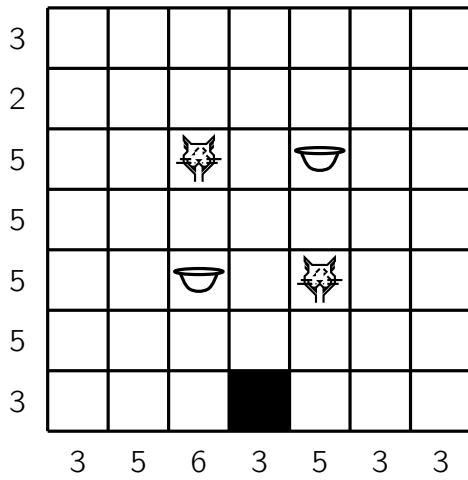

11

## Niveau 3

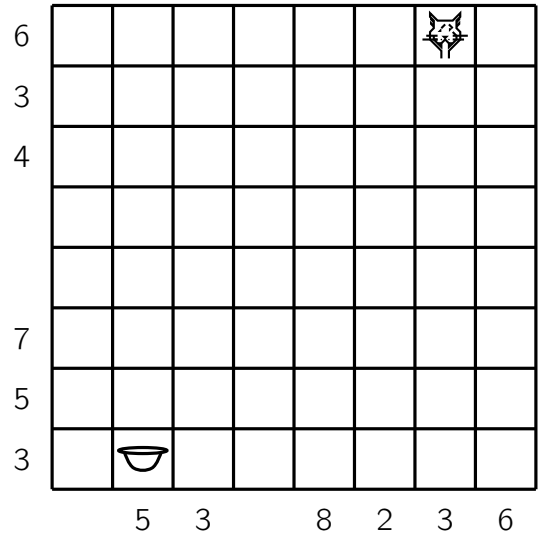

12

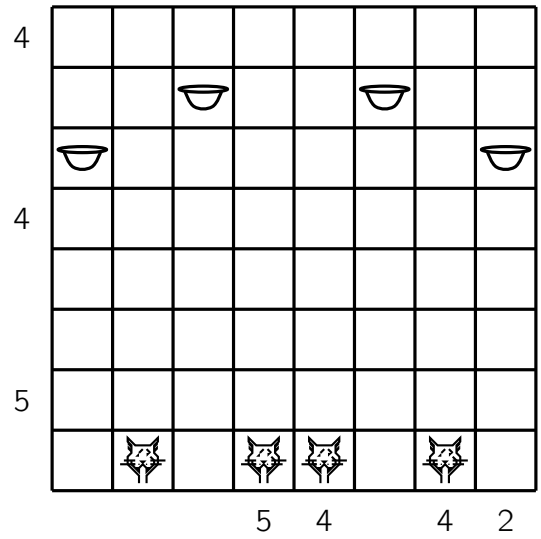

13

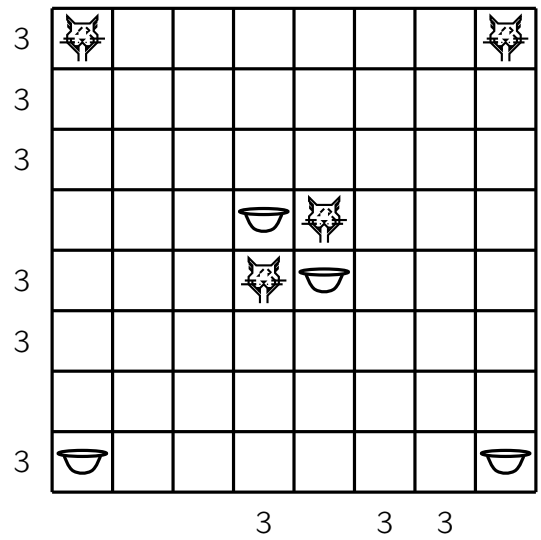

14

# Clôture

## Niveau 1

1

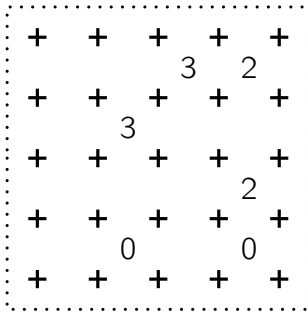

2

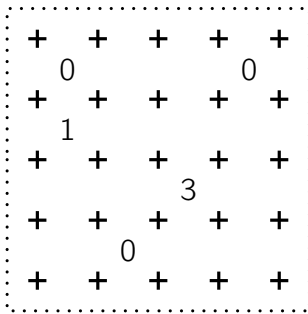

3

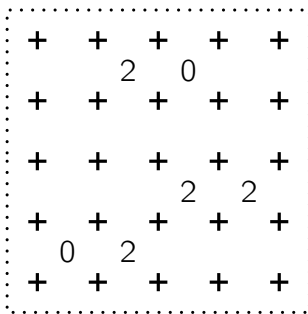

4

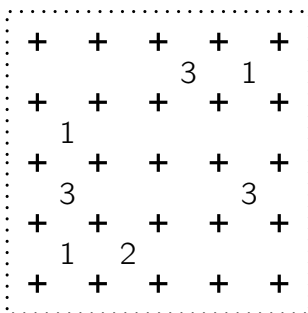

5

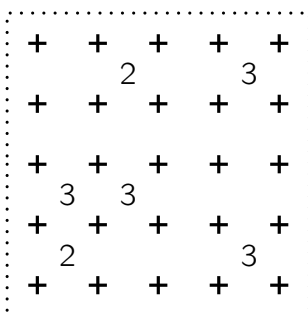

6

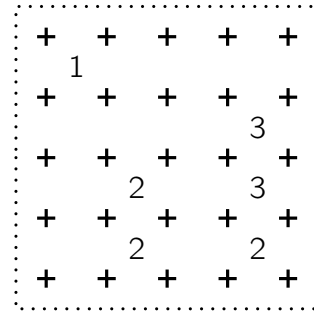

## Niveau 2

7

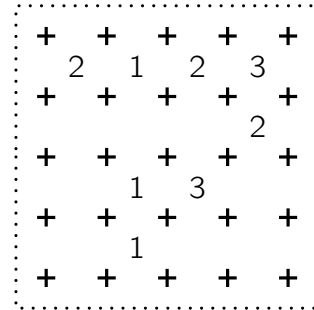

8

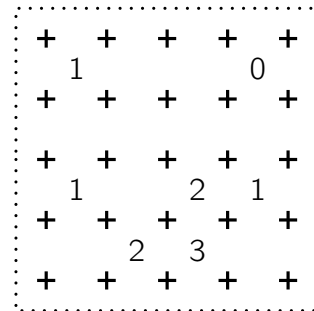

9

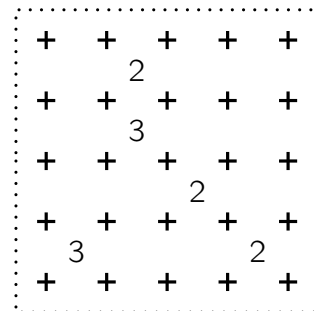

10

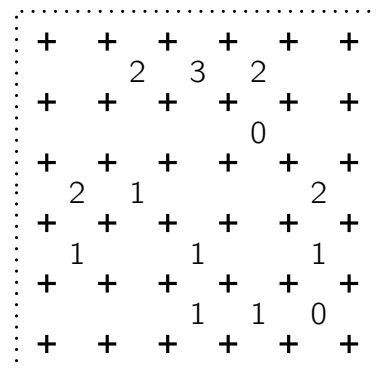

11

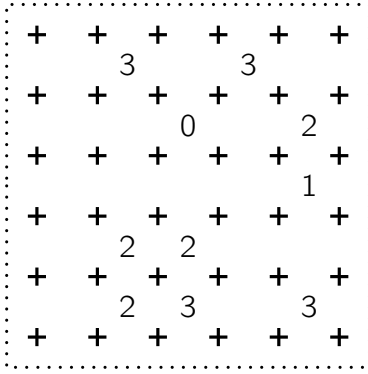

15

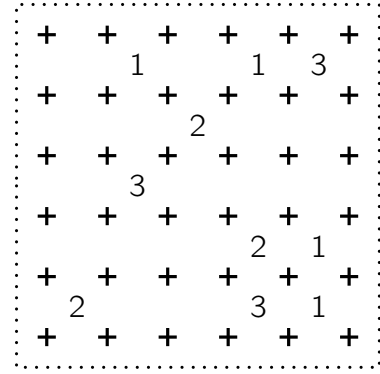

12

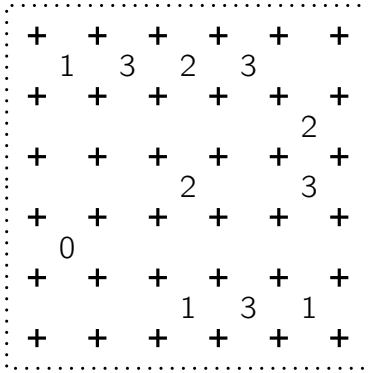

16

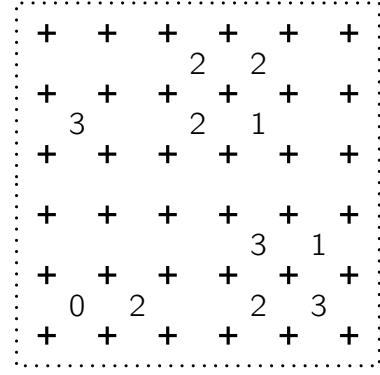

13

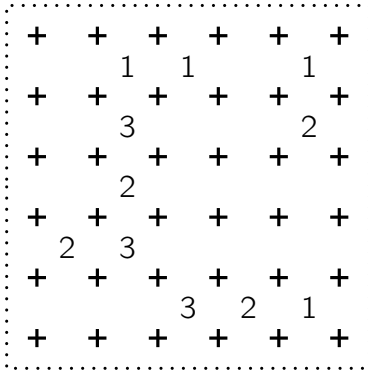

17

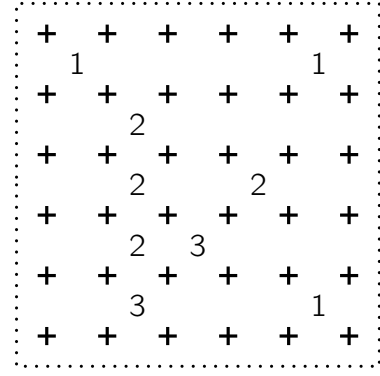

Niveau 3

14

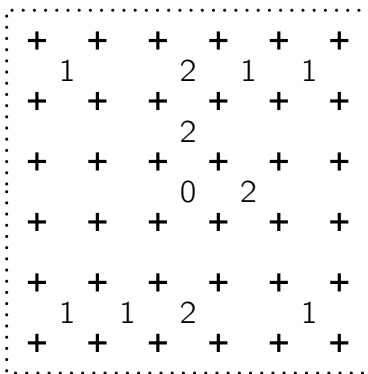

18

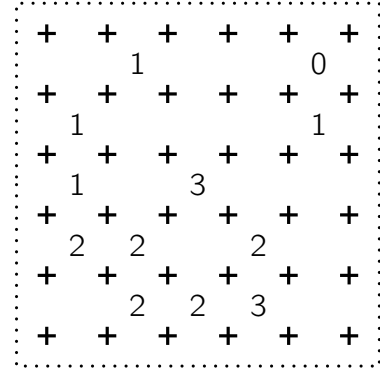

19

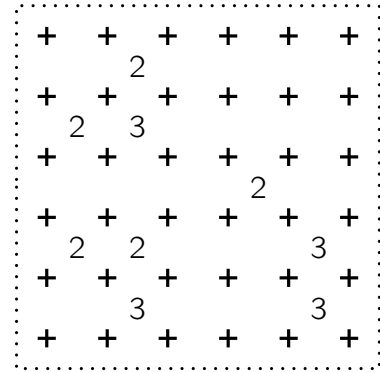

# Démineur

## Niveau 1

1

	1		2	
3		2		

2

			2	
2	2		2	
	2		2	2
	2			

3

1	3		2	
				0
		2		
2				
	3		1	0

4

	0			2
1		4		
			3	2
3		4		
	2			1

5

				0
1	4		4	
				3
1		4		
	0			2

6

0			2	1
		3		
	3	3		
		3	3	
	3			0

7

2				
4			3	
			0	
4	5	4		1

8

2			2	
	4		3	
3				
	5	3	3	
	3			1

9

2	2			2
		4		2
			1	1
2		3		1
0				

10

	1	2		
	3	4		2
1			3	
2		3		
	2		2	1



## Niveau 2

11

2			
		1	
	2		
			1

12

1			2
		5	
3			2
		1	
1			1

13

1		4	4
2		5	1

14

			2	
	3			2
1			5	
		1		3
1				1
		1		

15

			1	
2		1		5
	1			
				2
	1		3	1
		1		

16

	2	1		
	4		3	
1				2
			5	
1		3		2

## Niveau 3

17

		2		
1				3
			3	
4				4
			3	

18

			3	
	1			3
		2		2
1			4	
	3			1
		1		

19

			1	
2		1		5
	1			
				2
	1		3	1
		1		

20

1					1
		4	3		
	3			1	
	3			1	
		5	4		
2					1

# Diamants

## Niveau 1

1

		2	
	4		3
1			
	1		2



5

6

0			2		1
	4			4	
			3		
		2			
	2			3	
1		2			2

2

		2	
		5	2
3			
	3		



7

7

	2			3	
					1
1			1		
		3			2
0					
	1			3	

3

0				2
	4			
		3		
			2	
3				0

8

		1			
	4				
2			4		
		2			0
				3	
			1		



9

4

2				1
		4	2	
2	2			
		2	2	
	2			1



7

9

				1	
2		5			
				2	
	1				
			6		2
	3				

5

	2		3		1
	3		2		4
	3		2		2

10

		2		2		
	1				1	
0			1			1
		3		1		
2			2			1
	3				1	
		1		1		

14

	2				1	
2		3	2	2		2
	2				2	
		1		3		
	2				2	
1		4		3		1
	2				1	



14

11

		2			0	
3						
		1		4		2
3		1		3		
						4
	1			1		



15

15

2			1			0
		2		2		
	2				2	
1			3			2
	2				2	
		4		1		
1			2			1

12

	3		2		4	
		0		5		
3						2
			1			
0			5		2	2



22

16

			3		2		
	3			4		4	
1	1	3				2	
				4	5	5	
	3	3	3				
2					4	4	3
	3		3			4	
		2	1				

Niveau 2

13

	1				1
			2		
	1	2			
					1
3			2	3	
		2			



12

# Disconnect Four

## Niveau 1

1

+			○		
	+			○	+
○			○		
	+	○		○	+
		○	○	○	
○			+		

2

○	+			+	○
+		+	○		○
	○			+	
	+			+	
+		+	+		+
+	○			○	+

3

+				○	○	
+	+	+			○	
○	+		○	○		+
		+				+
○	+	+	○	○	+	○
+	+	+		○		

4

	○			+		
			+			○
	○	+				
						○
		+				
		+		○		○
○	+		+			

5

○		+	+		○
	○		+	○	+
○					
				○	○
○	+	+			+
	+	+		○	○

6

+	○		○	○	+
+	+				○
	○				
+		○	+	+	○
	○	○		+	○

7

○	+	○		+	○	○
+		+				+
○	+				○	
			○		○	
○						
○		○		+		+
○	+	○		○	+	○

8

+				+	+		○	
	○							
+				+			○	+
						○		
+	○		○					
			○	+			+	
+	○	+				○	○	
	○			○			○	
+			○	○			+	+

## Niveau 2

9

○		+	+		○		○
		+	+				
○			○		○		○
		+	○	+	○		
	+			○			
	○	+				○	○
+	○			+		+	○

10

	○	○	+			+	○
○					+		
○			○		+	+	
		+					○
	+	○				+	
		+	○			○	
	○	○				+	
+	+				○		○

11

+	+			+		+	
			+				○
+	○	○					
			+	+	+		
	+						
○				○	○		+
+	○	+				+	○

12

○		+	○			○	○		
+	+					+		○	
	+	+			+	+			+
○			○					+	
		○		+	○	○		+	
		○	○				○		
	+					○	○		+
○	+			+	+				
○			+	+		+			+
+	○	○			+		○	+	

## Niveau 3

13

	○			+			+	+
+	○			○		○		+
	+		○		+		+	
+	+							
		○		○		○		+
			○	+			+	
						○		
+		+	○					
○		+			○	+	+	○

14

		○	○			○	○	
○	+	+				+	○	
		+	+			+		+
						○		
○			○					
	○	+			○		+	○
	○		+	+		○		
+			○			○		
+	+						+	+

# Dominion

## Niveau 1

1

D			A	A	
		D		A	
D			F		E
	G				
		G	F		
G			G		C
			B		C
		B			

2

		B			C
	B				
				C	
F		C			D
	F			D	
F			D		A
					A
	E			A	A

3

	C		C		G	A
		C		C		
			J	A	A	
J		J				A
		J		A		A
B		D			A	
				D		H
	B			D		H
F		I			E	
	F			E		H

4

D			F			
		D		F		F
	D					
D			E			
		E				B
	E				B	
C						B
					A	

5

B			F			F
	B				F	
		B		F		F
	B		B			
Q				E		
		B			E	C
	D		E			
D				E		A

6

	A			E		E		
A		H						
						E		K
	D			H			K	
				H			B	
	D							I
		D		H		I		
G								I
	G		J		C			
		J		J			C	F

7

		F				E
F			F			
	A					
		A	G		B	
A			G	G		B
		G				
D					C	C

10

				D		C
					C	
	E					C
				B		
		F				B
F			A			
		A				
	A			A		B

### Niveau 2

8

H			B		J		
		B					E
	H				A		
			G			A	
					A		F
			G				
	C			G			D
			G		A		
		I					D
C						I	

### Niveau 3

11

						B		
	D							
		D				B	J	J
					C		J	
G		D				C		J
	A							
			H				E	
								E
			H			F		
I				F				E

9

			F		F			J
	I					J		
I								J
	I			G				C
		D				G		
				H				C
							A	
B			H			A		A
				E				

12

					C			D
				H				
						C		
								E
G		G					B	
					A			
	A						I	
								F
	K							I
					J			

# Dominos

## Niveau 1

1

1	1	0	3	0
3	3	0	1	1
1	2	3	2	0
2	2	3	2	0

			3•3	
		2•2	2•3	
	1•1	1•2	1•3	
0•0	0•1	0•2	0•3	

2

3	2	2	1	3
1	1	0	2	2
2	3	3	0	0
1	3	1	0	0

			3•3	
		2•2	2•3	
	1•1	1•2	1•3	
0•0	0•1	0•2	0•3	

3

4	1	4	4	4	1
3	3	1	1	1	4
0	3	0	3	2	2
0	3	0	3	4	0
2	0	2	1	2	2

				4•4	
			3•3	3•4	
		2•2	2•3	2•4	
	1•1	1•2	1•3	1•4	
0•0	0•1	0•2	0•3	0•4	

4

3	3	3	2	4	3
2	0	1	1	0	2
4	0	4	0	4	4
3	4	0	3	0	1
2	1	1	2	2	1

				4•4	
			3•3	3•4	
		2•2	2•3	2•4	
	1•1	1•2	1•3	1•4	
0•0	0•1	0•2	0•3	0•4	

5

2	2	0	0	1	4
1	0	0	0	1	3
1	4	1	4	0	4
1	2	2	4	3	2
3	3	4	3	2	3

				4•4	
			3•3	3•4	
		2•2	2•3	2•4	
	1•1	1•2	1•3	1•4	
0•0	0•1	0•2	0•3	0•4	

6

3	0	2	3	2	0
4	1	4	0	3	4
4	1	1	2	2	4
2	3	1	0	1	2
0	0	1	4	3	3

				4•4	
			3•3	3•4	
		2•2	2•3	2•4	
	1•1	1•2	1•3	1•4	
0•0	0•1	0•2	0•3	0•4	



## Niveau 2

7

2	3	3	4	4	3
3	0	0	0	4	2
3	1	0	0	4	1
1	4	2	1	4	3
1	0	2	2	2	1

				4•4
			3•3	3•4
		2•2	2•3	2•4
	1•1	1•2	1•3	1•4
0•0	0•1	0•2	0•3	0•4

8

4	4	1	4	3	3
1	0	1	0	1	4
2	3	4	2	2	1
2	3	3	4	1	2
0	0	2	0	3	0

				4•4
			3•3	3•4
		2•2	2•3	2•4
	1•1	1•2	1•3	1•4
0•0	0•1	0•2	0•3	0•4

9

3	2	0	4	3	4
3	1	0	1	2	4
3	4	3	1	4	0
1	0	4	3	1	0
2	2	2	1	2	0

				4•4
			3•3	3•4
		2•2	2•3	2•4
	1•1	1•2	1•3	1•4
0•0	0•1	0•2	0•3	0•4

10

4	1	4	2	4	3
4	1	4	2	3	0
0	2	1	2	1	0
0	3	0	3	3	0
4	1	1	3	2	2

				4•4
			3•3	3•4
		2•2	2•3	2•4
	1•1	1•2	1•3	1•4
0•0	0•1	0•2	0•3	0•4

11

0	2	2	3	2	2
3	3	3	4	4	3
1	0	4	4	4	0
1	1	1	2	1	0
1	0	3	2	4	0

				4•4
			3•3	3•4
		2•2	2•3	2•4
	1•1	1•2	1•3	1•4
0•0	0•1	0•2	0•3	0•4

12

2	3	3	1	4	1
4	4	4	2	0	0
3	0	1	0	3	3
3	1	2	2	2	0
2	4	4	1	1	0

				4•4
			3•3	3•4
		2•2	2•3	2•4
	1•1	1•2	1•3	1•4
0•0	0•1	0•2	0•3	0•4

# Doughnut

1

	7		6
	1	5	
	4		
3		2	

2

5			1
	3		
2	6	4	

3

1		5	
7		2	
3	6		4

4

		5	7
	1		
4		6	
3		2	

5

		4	2
3		6	
5		1	

6

	5		7
4	1		
6		2	3

7

3	6		4
		2	

8

			5
		1	
4			3
	7		

9

4		1	8
	5		
		6	
	7		

10

6			3
2		7	
	4		

11

4		1		6
	2			
		5	3	

12

		3		4
5	1	6	2	

13

		6		1
3			4	
		2		7
5				

14

				1
7				4
		5		
				2
	3		6	

15

				4	1	2
						6
						3
						5

16

				5	2
	1		6		
					4
7		3			

17

					3
4		7			1
	2		5		
6					

18

					1
	3		7		
					5
		2			
	6		4		



Niveau 3

6

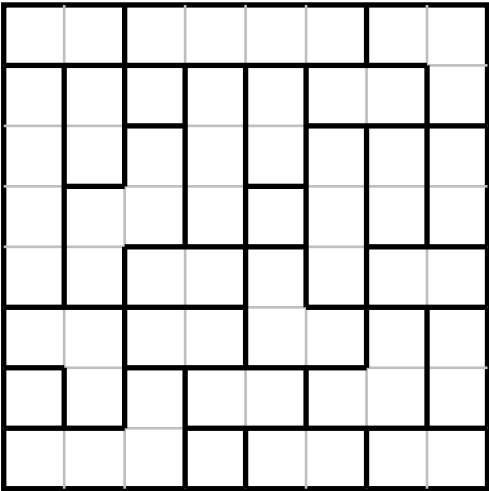

7

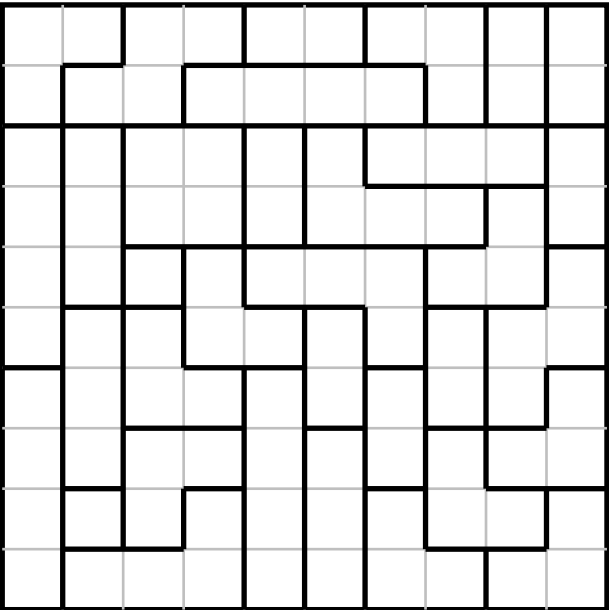

8

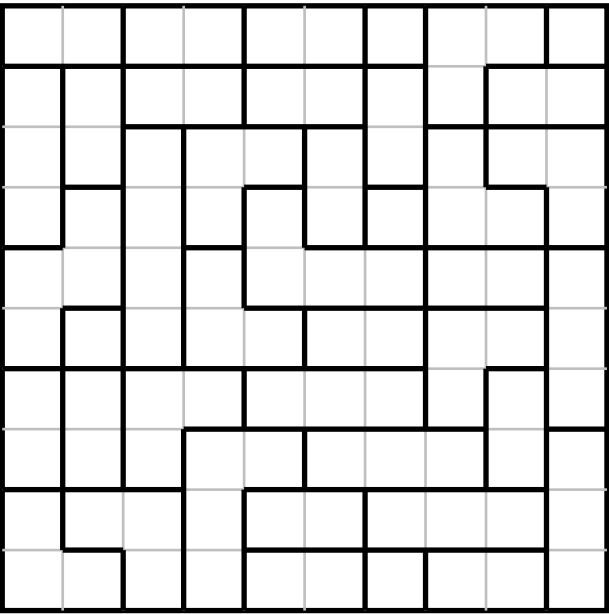

9

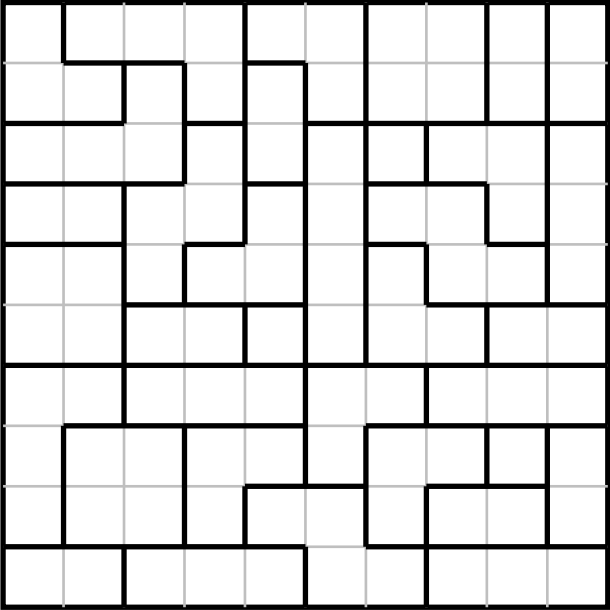

10

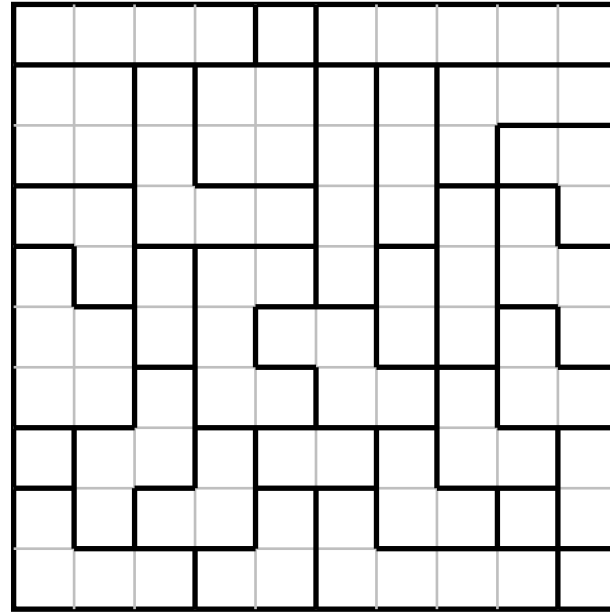

# Eulero

## Niveau 1

1

			1
	D 2		A 4
	C		
1			

2

		C	
	4		
	C 2		
3 D			B

3

B		4	
	B		D
1		A 2	
	C		

4

2			
A 3			D 1
C	A	2	

5

1	C 4		
4		3	
2		D	
	D	A	

6

D 1	E		A	
	C 3	E 4	5	
E	A 5	1	4	2
		D		E
5		A 2	1	B

7

D 2	E			B 5
	2		1	C 4
			5	A 3
A		E	2	D
B 4	C	A 1	3	

8

C 5	A 3	D 1	4	B
		C	D 2	A 1
	B	2		4
E				5
	D	5	C	3

9

2	3	B	4	
D 3	A 5	4		B
	B	D 1	A 2	E 3
	1			
B	2	A	E	

Niveau 2

10

		2	
	3	1	D
2			B
	A		

11

1	C		
			A
	B	4	3
		C	

12

4	1		
			D 1
	3	B	
A		D	

13

	A		B
		D 3	
4			1

14

	4	3		D 1
4		B 2	5	E
2	E	A 1	D	B 4
1			C	A
3			B	5

15

		A 3	D	
	C			A 4
	A 5	D 1		B 3
3	B 4		A	D 2
A	3	C		E 1

16

D	C	E 2	A	4
B	E 5	A 4	D 3	C
				2
	2	D	B	3
		B	2	A

Niveau 3

17

3			
			D
A 1		4	C
	4		

18

3	B			
		5	4	1
		1	5	
C		2	D	
				E 2

# Faktorism

## Niveau 1

1

				6					
					3				
				14					
					18				
	9	36	45	63		54	90	72	
					6				
					10				
						30			
					16				

2

		90		27		36		63	
									4
	64								6
	80								
									12
	8								
									10
			24		20		4		

3

		10							
								64	
		2							
						49			
		6							
				81					
		20							
			16		12		40		4
	36								

4

	16								
			12	42	36	18			
		15							
		25							
		50							
		35							
							81		
									1
								64	

5

		7	2	3	8	1	5	4	10	9
						1				
							25			
									100	
	36									
		49								
			4							
										81
								16		
						64				

6

							14			
							4			
	3	9	27		18		15	21	24	12
							12			
							2			
							18			
							16			
							10			
							20			



## Niveau 2

7

54			27						
		9							
	15								
					42				
				56					
			50						
								20	
								32	
							4		

8

60							48		
				32					
			28						
	50								
							10		
					21				
			6						
		9							
								18	

9

32								48	
								16	
	42								
							21		
		40							
					50				
			45						
				9					
				6					

10

	56								35
								4	
							10		
				20					
					9				
						63			
				32					
		60							
	54								

## Niveau 3

11

	6	15							
		21							
									30
								28	
							40		
						10			
						8			
					48				
			18						

12

									8
	63								
		4							
			15						
				60	20				
						40			
							42		
								27	
									10

# Fillomino

1

1				2
	3			
		3	1	
	1	2		
		3	1	

2

1		1		
	2			3
		2	2	
3				3
1	3			

3

1				
	3	2	2	
4	3		3	3
	2	2	3	
				4

4

3			1	
		4		
2	2		2	2
		3		
	3			4

5

4	3			
2		1		2
	1	2		
		2		1

6

4			2	1
2		1	2	
	3	1		2
2	2			3

7

	2	1		2
	3			4
	4		2	
3			2	
1		2	1	

8

4		1		
	1	2		
			3	
	1	2		1
2				

9

	1		1	
2				
	4	3	2	
				3
	3		3	

10

1	2	3		
		4	4	
4	1		4	4
	3	2		
		3	1	3

11

4	1		2	
	2		1	
				2
		2	1	

16

1	2		2	1
		3		
			1	
3		1		
3		2		1

12

	3			1
		3		
	1		1	
2	3		3	2

17

	2	3				
	1	3	3	2	2	3
3		6				3
3		3		2		3
4				1		4
4	4	4	1	2	2	
				1	4	

13

	2	3		1
4	2			
	1			1
			1	
1	2	3		

18

3		5				
		4		4	4	2
3	4	3	3	3	4	3
2	2	1	4	4	2	3
5	5	3		4		
				4		3

14

	1			
2			3	2
3	3			1
	3	1	3	
				1

19

1	6	2			1	
				5		
2	3	3			3	
	5		5		5	
4				5	1	2
		1				
	4			6	6	6

15

1			3	
3				1
4	2		2	
	2			1
		1		3

# Fobidoshi

## Niveau 1

1

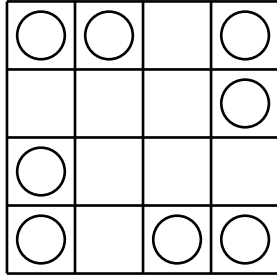

2

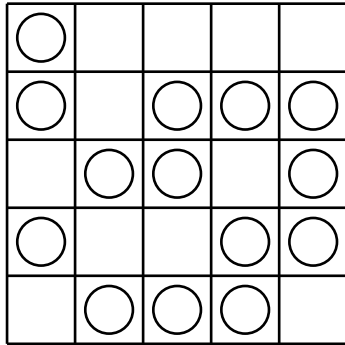

## Niveau 2

3

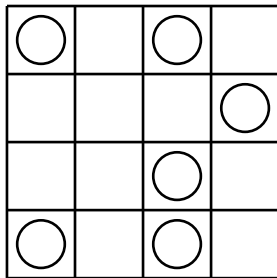

4

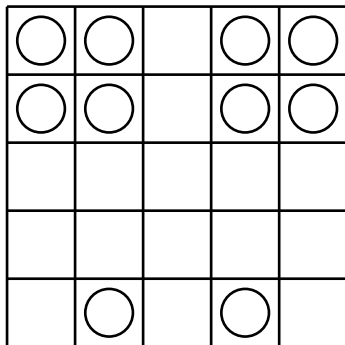

5

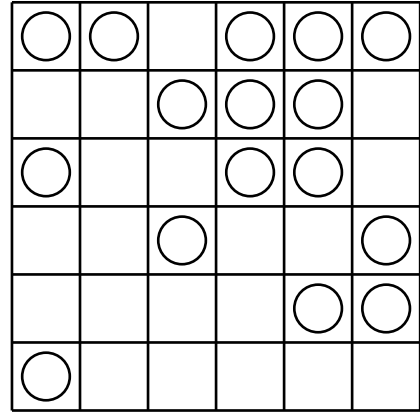

6

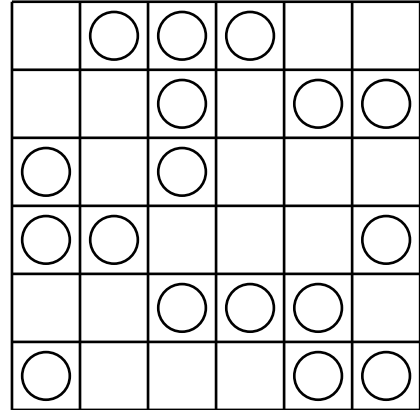

7

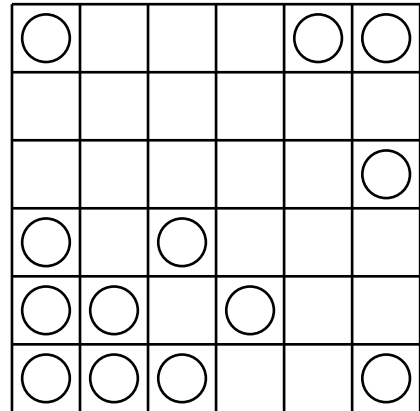

## Niveau 3

8

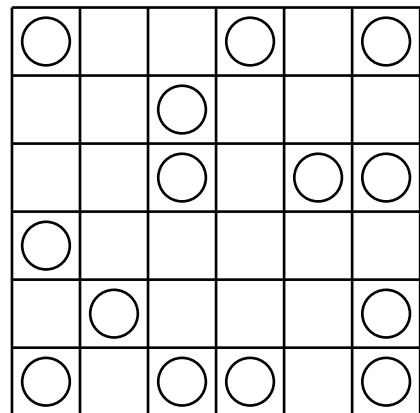

Niveau 4

9

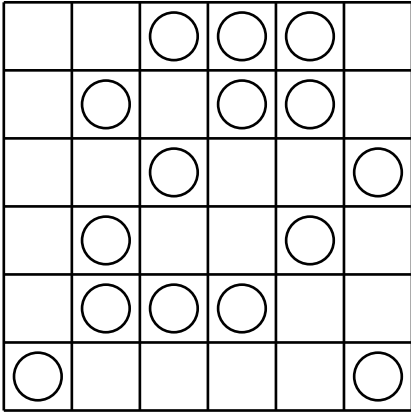

13

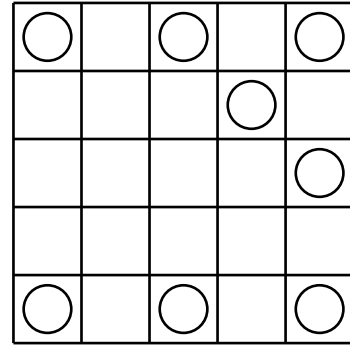

10

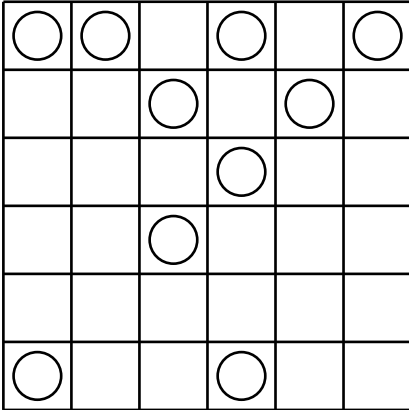

14

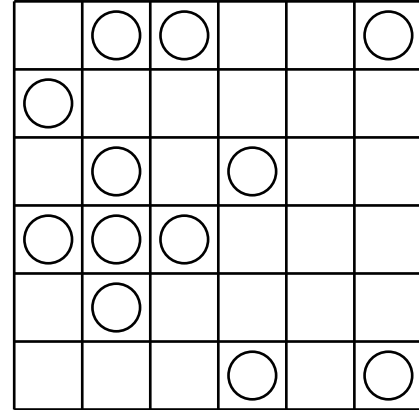

11

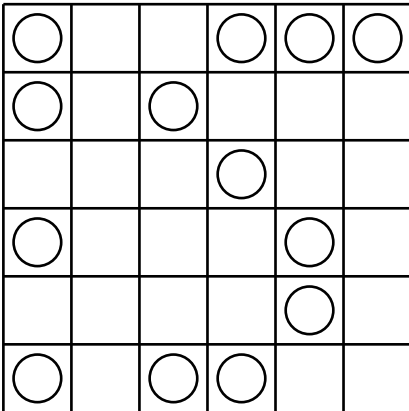

15

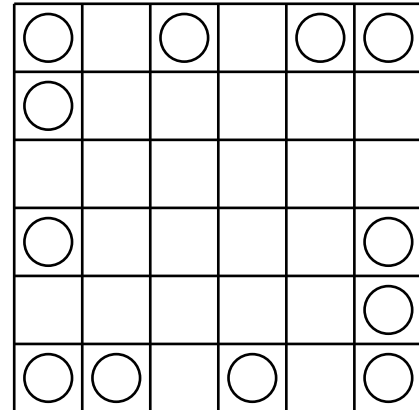

12

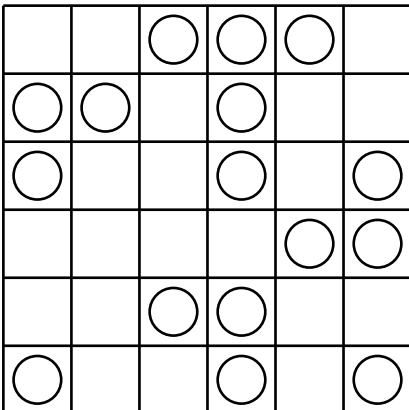

16

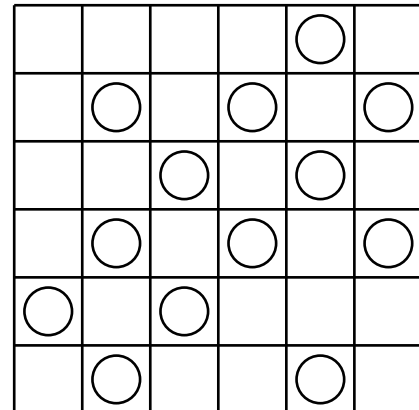

# Futoshiki — Inégal

## Niveau 1

1

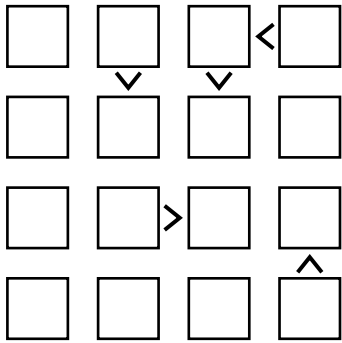

2

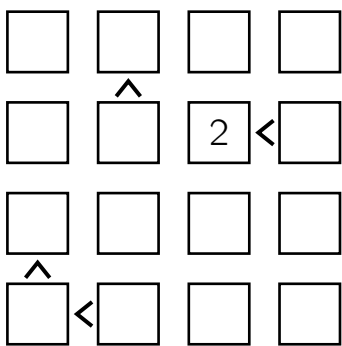

3

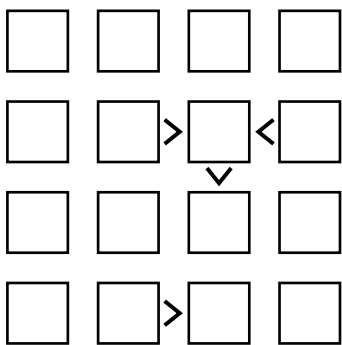

4

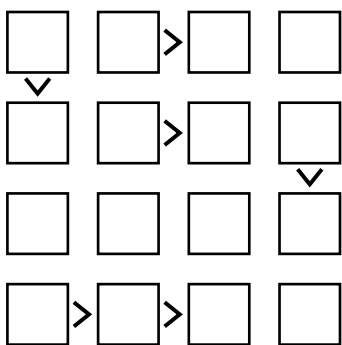

5

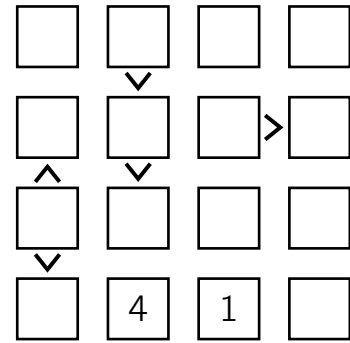

6

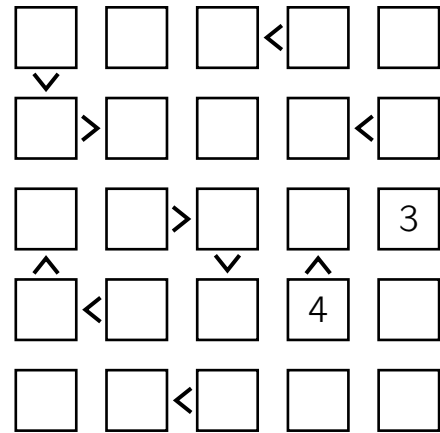

7

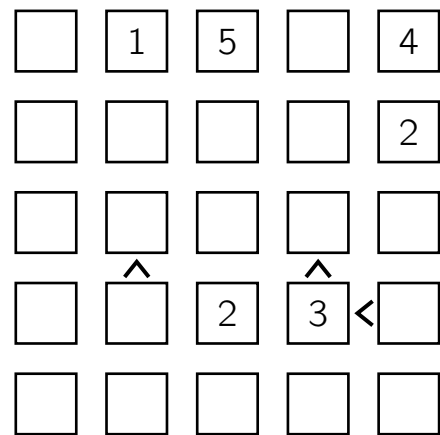

8

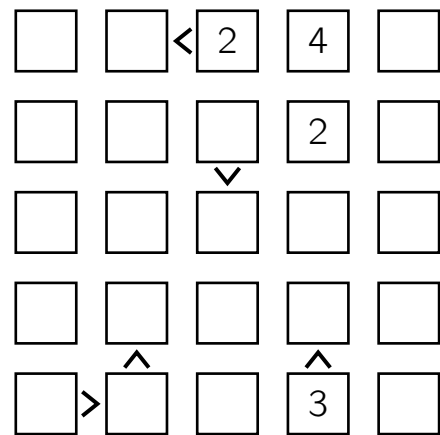

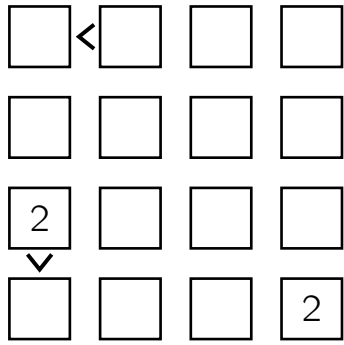

9

Niveau 2

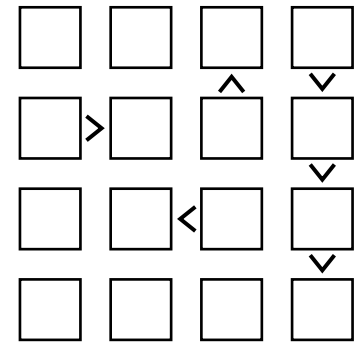

10

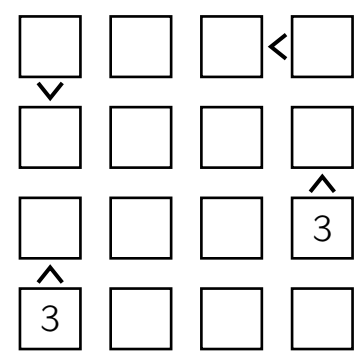

11

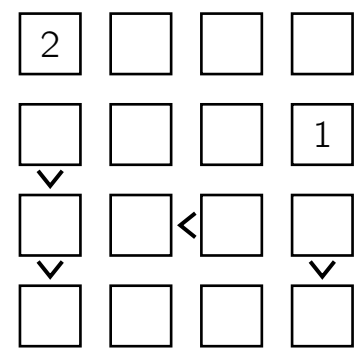

12

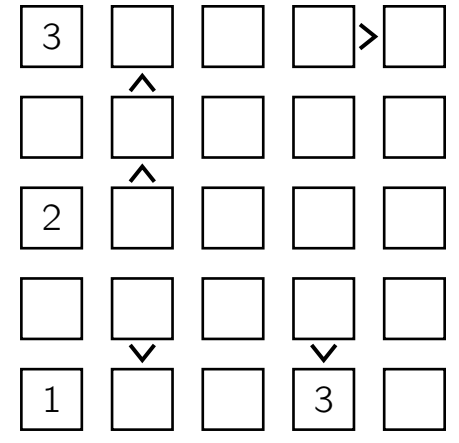

13

Niveau 3

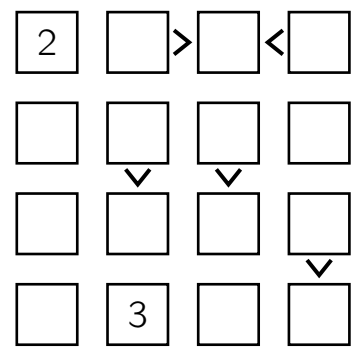

14

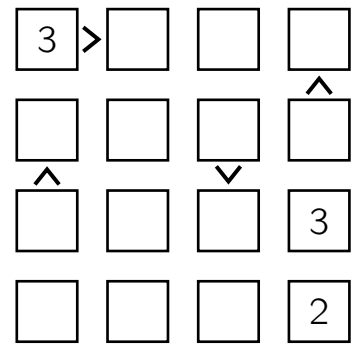

15

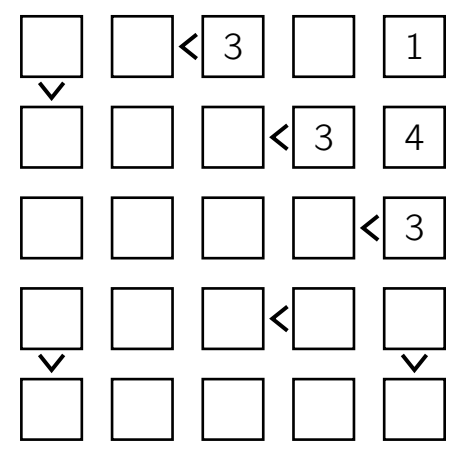

16

# Fuzuli

## Niveau 1

1

		2		1
	1			2
	2			
	3			
			3	

2

3			2	
1				
				1
				2
	2		3	

3

			1	3
		2		
	1		3	
2				1

4

2				
1	3			
		3	1	
		1		2

5

	1			
	2			1
			1	3
2				
		3		

6

	1	3	2	
		1		
1		2	3	
				3

7

	2			
				1
1				2
			3	
	3		2	

8

		2		
3				
		1		
	1		2	
			1	2

9

	2	1		
2	3			
	1			2
		3		

10

				1
1		3		
	3			
2				
	1		2	3



## Niveau 2

11

3	1			
1		2		
		3	2	
			1	

12

				3
		2	1	
1				
		1		
	3		2	

13

3		2		
1			3	
				3
			1	2

14

3	1	2		
2				3
1		3		
				2

15

2		1		
				3
	1	2		
3				

## Niveau 3

16

3	1	2		
			2	
		1		
2		3		

17

2				
		2		1
	2	1		3
	3			2

18

1			3	
2			1	
	3			
3	1			

19

			2	
			3	
	3	2		
				1
	1			

20

2				1
3			1	
			3	
1				3

# Galaxies — Tentai Show

## Niveau 1

1

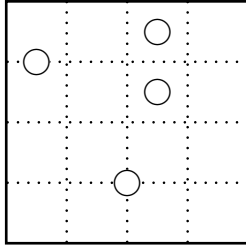

2

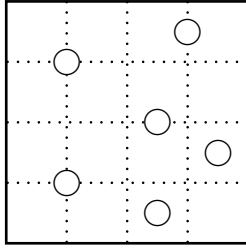

3

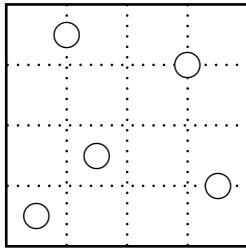

4

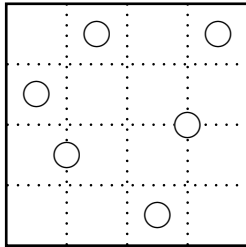

5

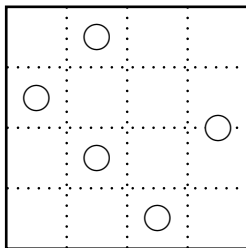

6

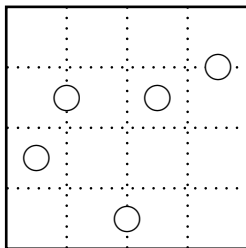

7

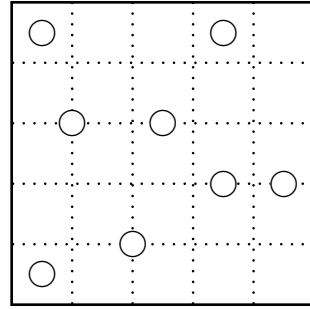

8

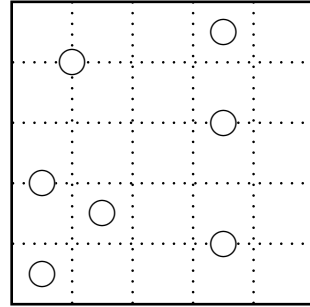

9

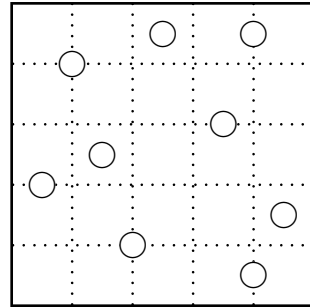

10

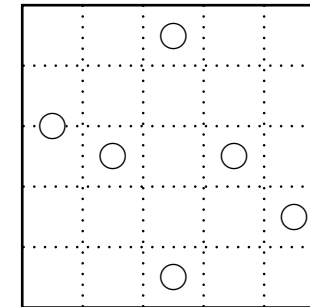

11

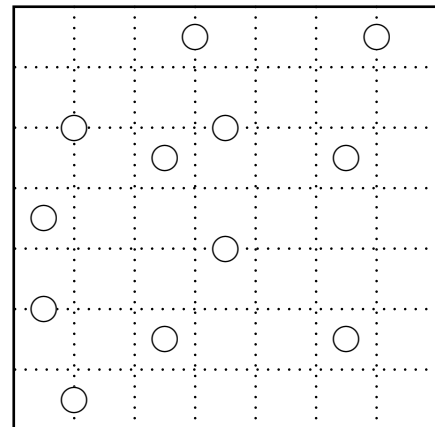

12

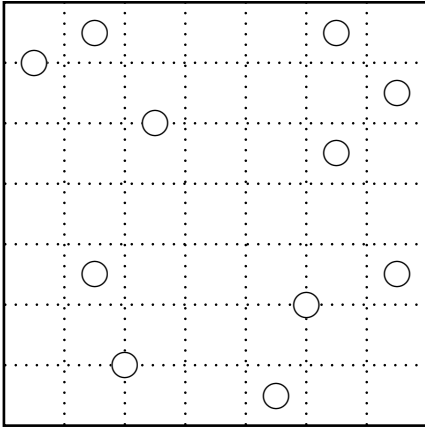

16

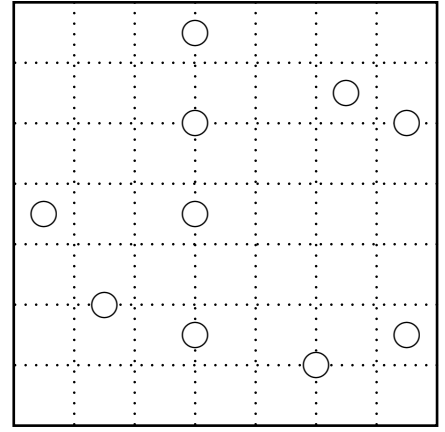

Niveau 2

13

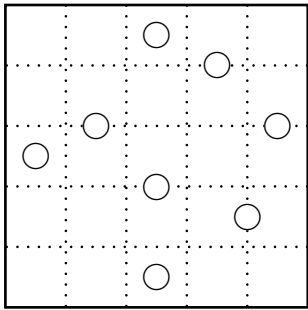

17

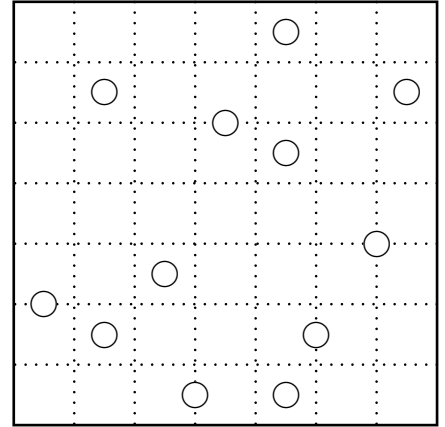

14

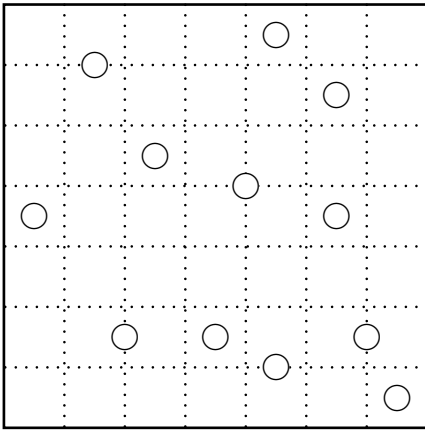

18

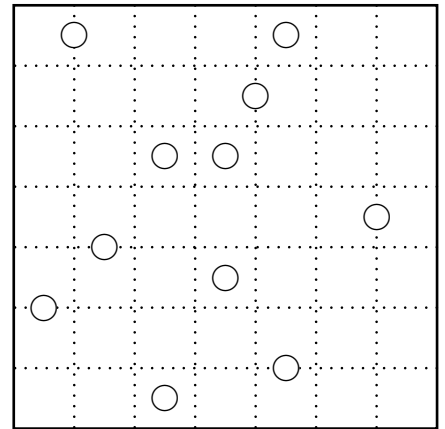

15

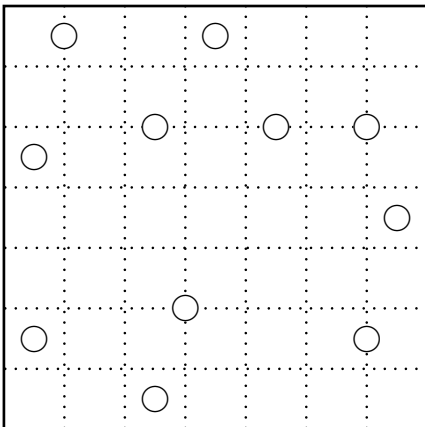

19

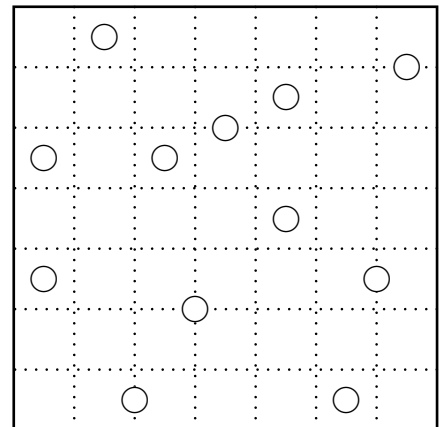

# Gappy

## Niveau 1

1

	1	7	3	3	1	1	1	1	1
1									
1									
1									
1									
2									
1									
1									
1									
2									

2

	5	1	6	1	1	1	5	4	3
3									
7									
1									
5									
1									
6									
1									
1									
2									

3

	1	5	3	3	7	1	5	1	5
2									
1									
2									
1									
1									
1									
1									
1									
1									
1									

4

	5	1	7	1	1	1	8	3	3	4
3										
8										
1										
1										
2										
1										
1										
3										
5										
1										

5

	5	1	1	1	1	2	1	1	7	2
7										
1										
7										
3										
3										
1										
1										
1										
1										
5										
1										

6

	1	6	1	7	1	1	1	1	8	3
4										
4										
4										
5										
1										
6										
6										
1										
1										
2										

**Niveau 2**

1 6 1 1 1 1 6 1 5

2

6

1

6

2

6

1

1

1

2

**7**

1 1 2 1 2 1 1 6 2

4

3

1

1

1

6

1

5

1

**8**

1 7 2 7 1 5 4 3 1 1

6

2

7

2

6

4

3

4

5

1

**9**

1 1 2 1 2 1 1 1 1

1

5

5

3

1

1

1

1

1

**10**

1 1 2 1 1 6 1 5 1

4

4

3

1

1

1

1

1

1

**11**

**Niveau 3**

1 1 3 5 1 1 3 3 3 1

2

7

1

6

1

1

2

1

1

2

**12**

# Grades

## Niveau 1

	1	1	1	2	1	2	
2							7
1							9
1							8
1							1
1							3
2							3
	3	9	1	2	8	8	

1

## Niveau 2

	1	2	1	1	0	3	
2							4
1							7
1							2
1							5
1							2
2							14
	6	12	8	3	0	5	

2

	2	1	1	1	1	2	
2							12
1							7
1							2
1							9
2							10
1							5
	3	4	9	7	9	13	

3

	2	1	1	1	1	1	
1							9
2							13
3							23
1							1
	9	8	6	9	9	5	

4

	2	1	1	2	1	2	
2							18
1							4
2							11
1							7
1							8
2							5
	14	8	4	10	9	8	

5

	1	0	2	1	2	1	
2							15
0							0
1							5
1							5
1							4
2							10
	1	0	13	5	15	5	

6

	1	1	2	1	2	1	
1							9
1							2
2							15
1							1
1							9
2							11
	9	9	15	7	3	4	

7

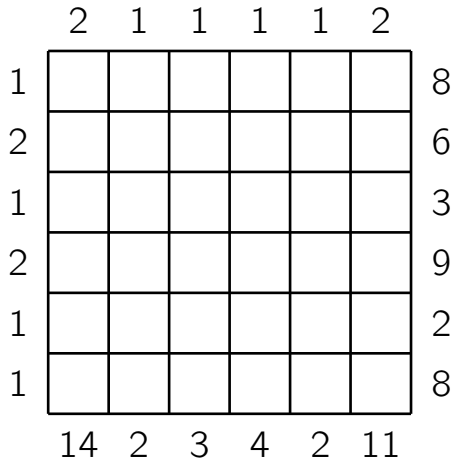

8

Niveau 3

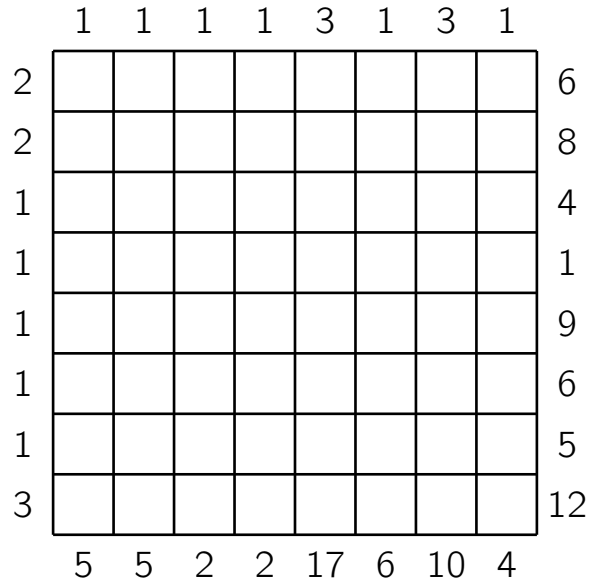

11

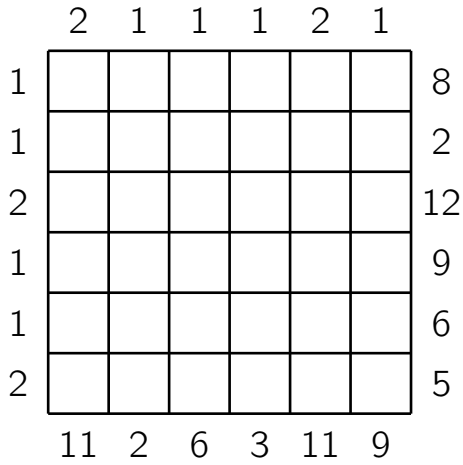

9

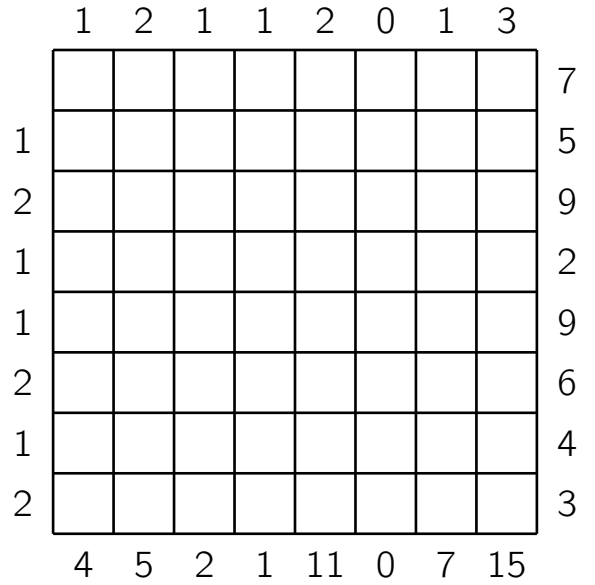

12

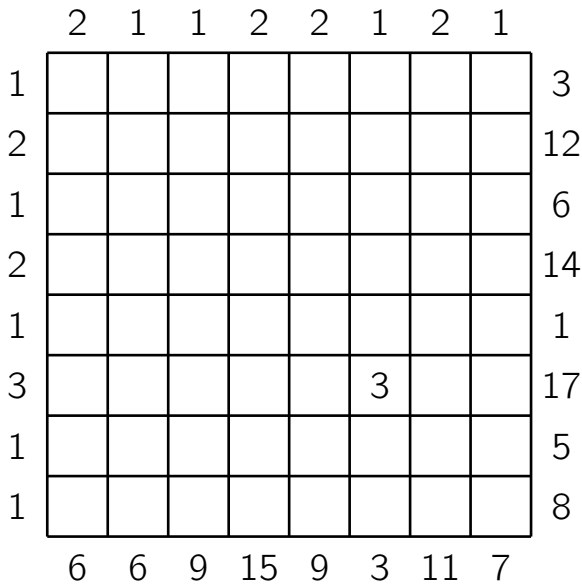

10

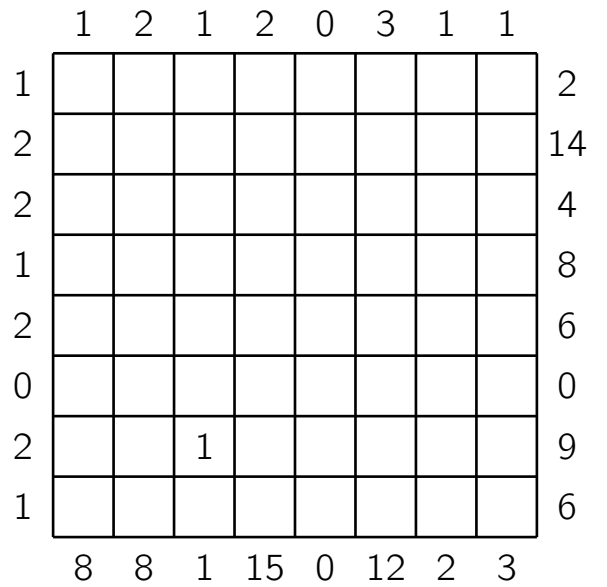

13

# Gratte-ciel

## Niveau 1

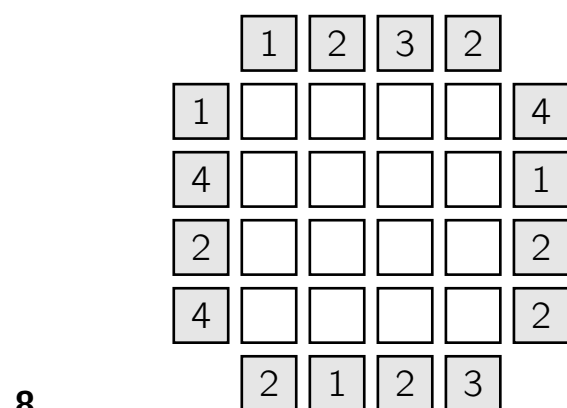
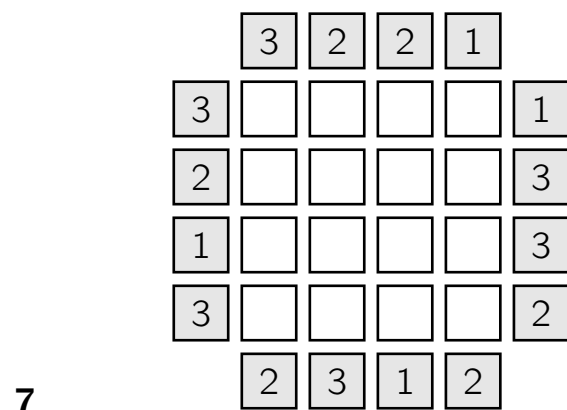
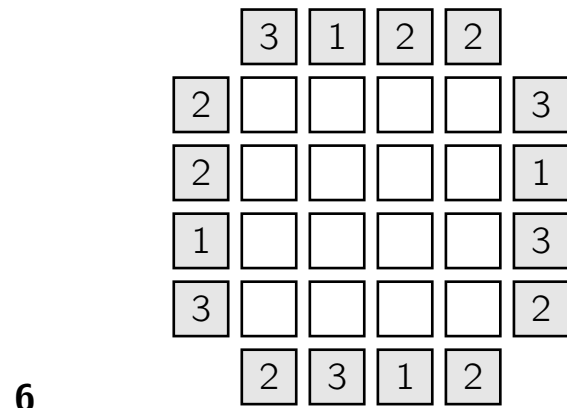
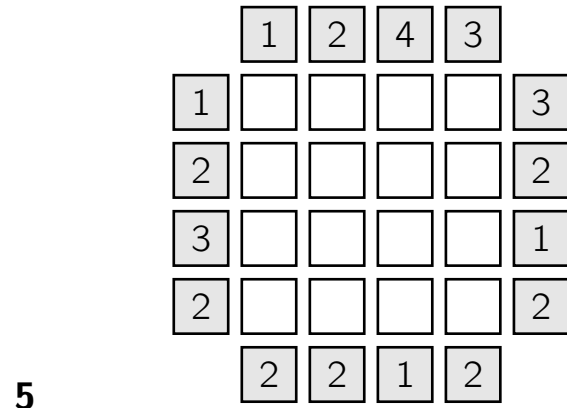
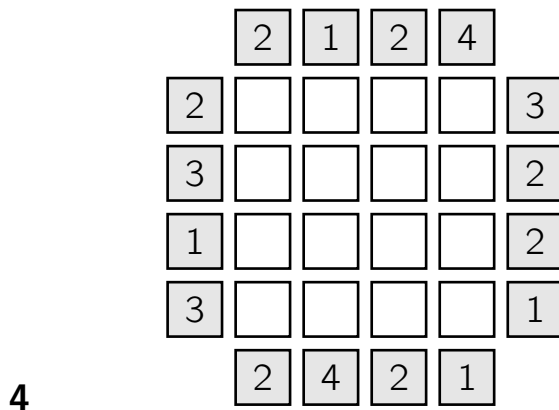
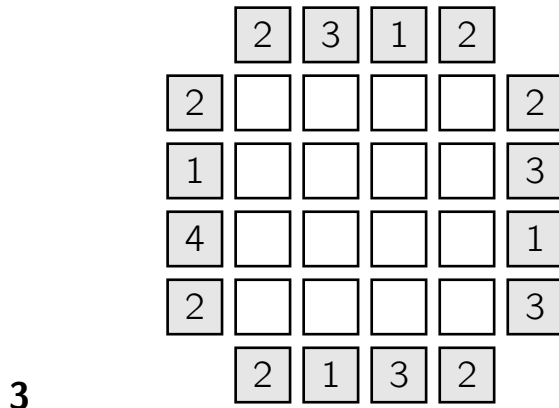
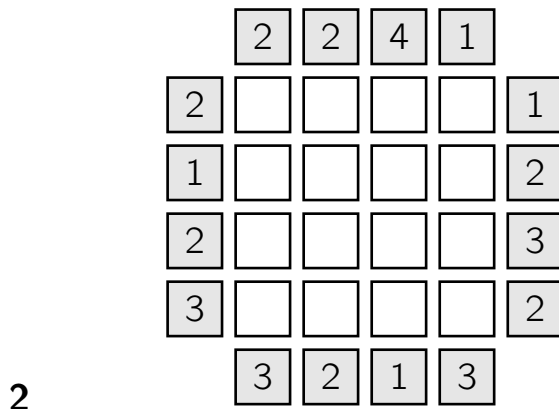
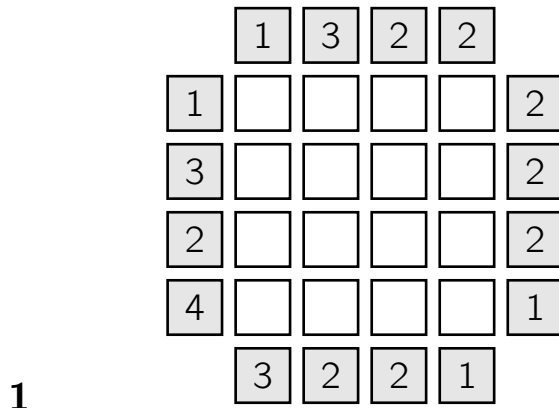



## Niveau 2

9

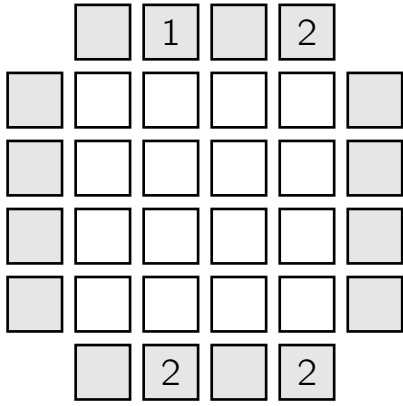

13

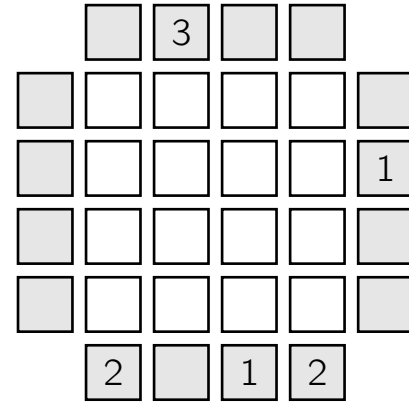

10

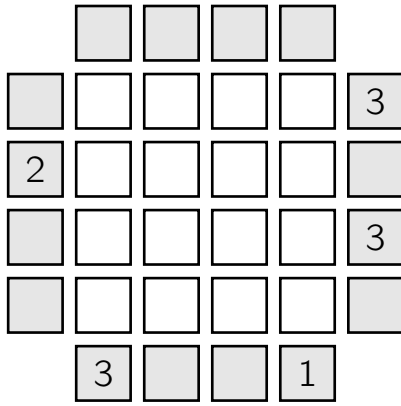

14

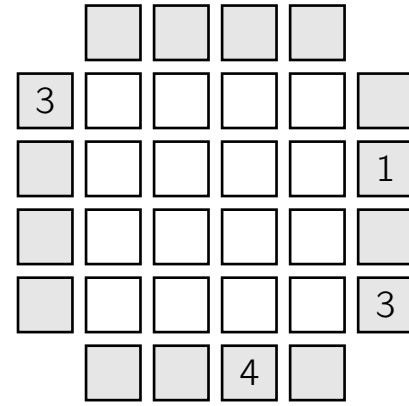

11

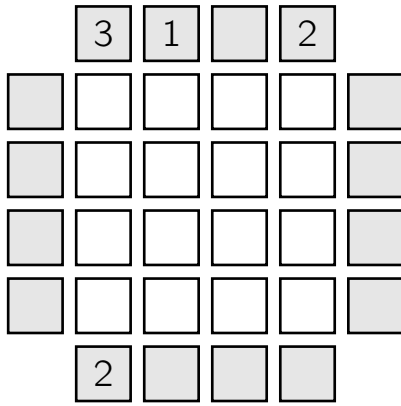

15

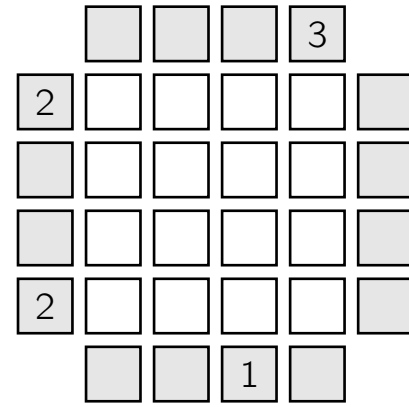

12

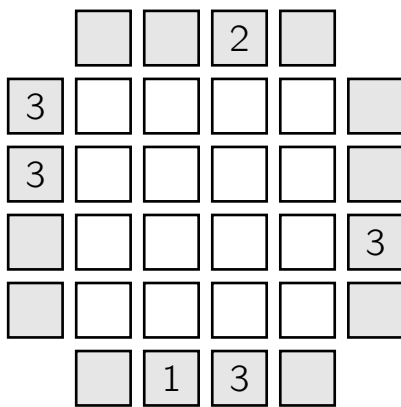

16

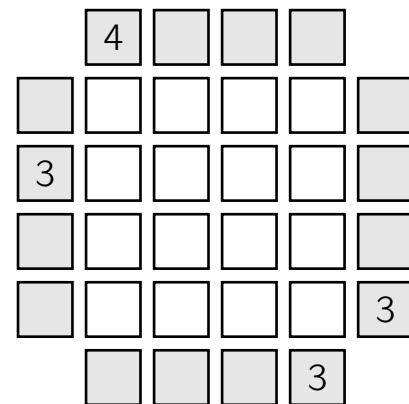

# Gyokuseki

## Niveau 1

1

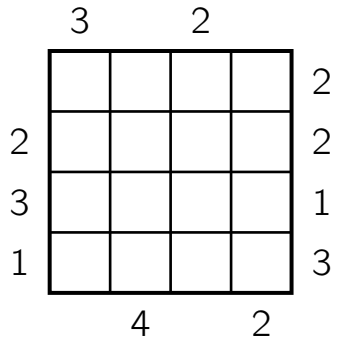

2

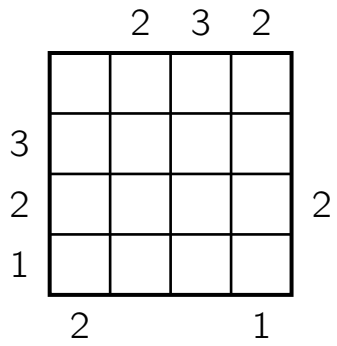

3

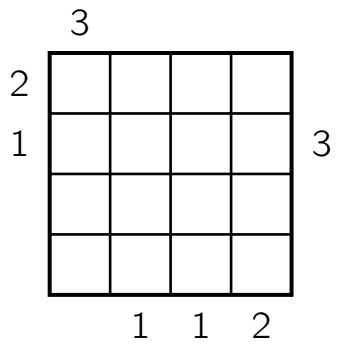

4

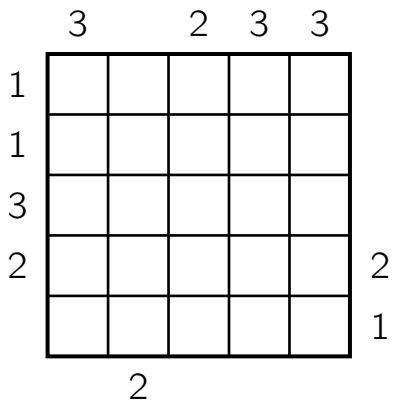

5

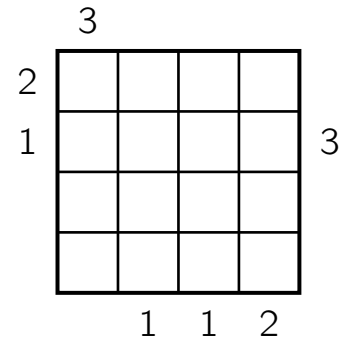

6

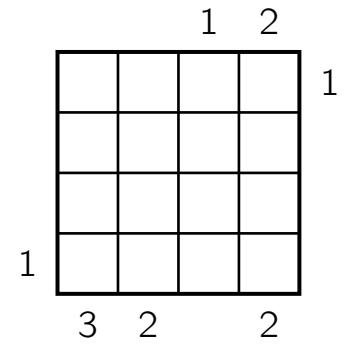

## Niveau 2

7

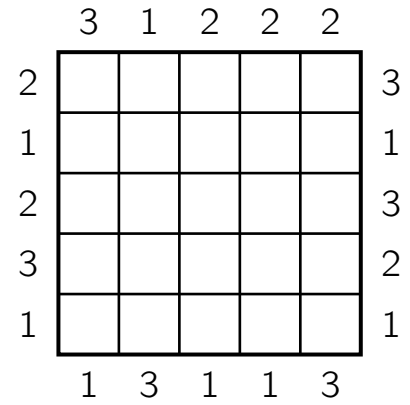

8

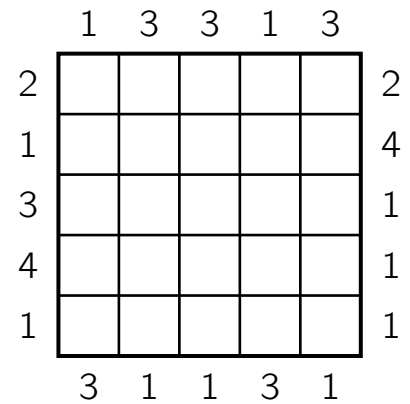

### Niveau 3

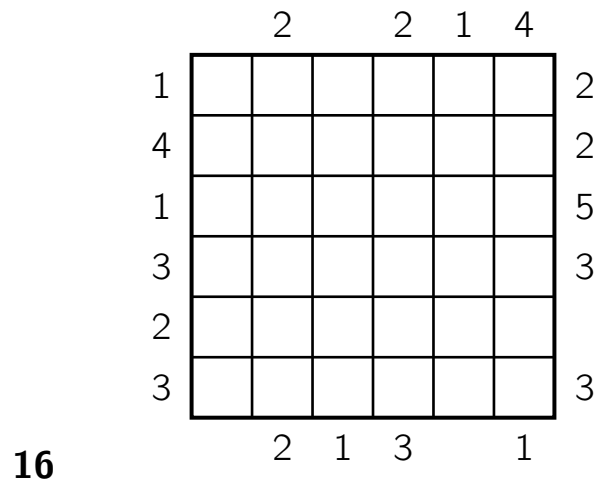
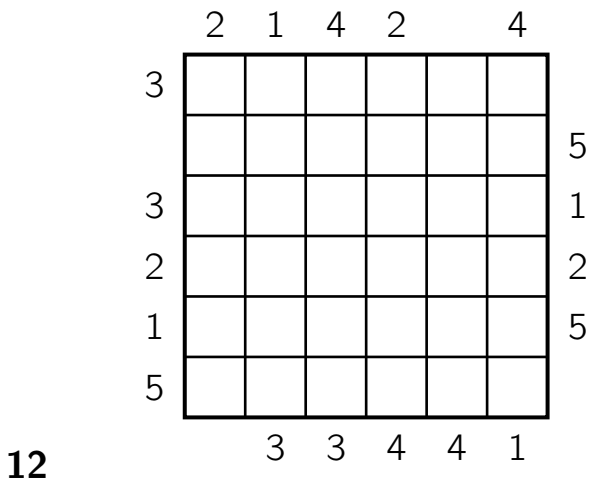
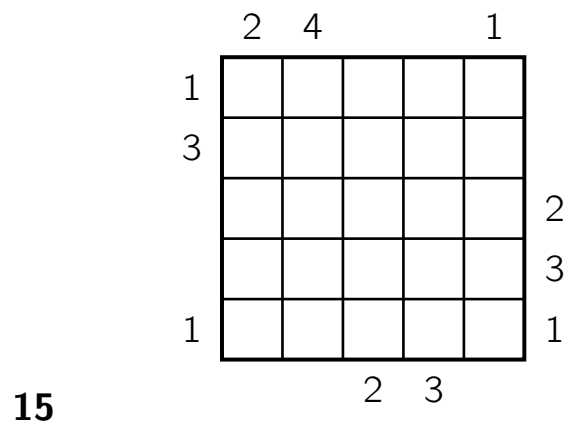
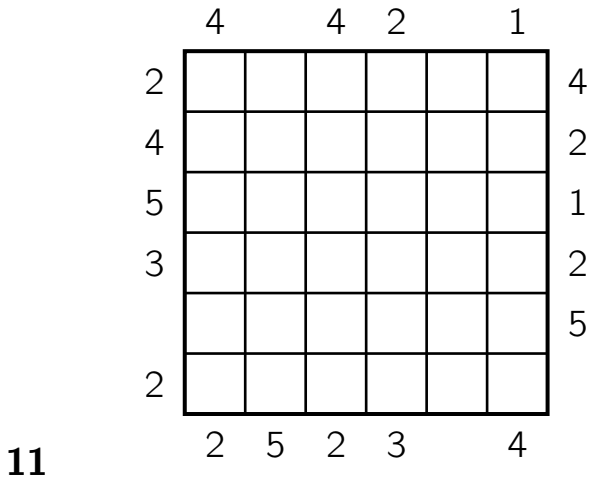
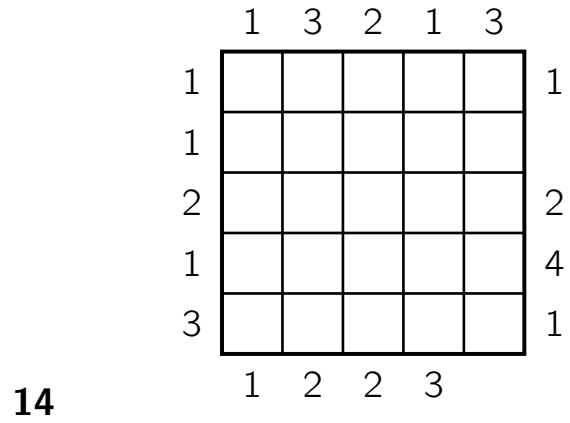
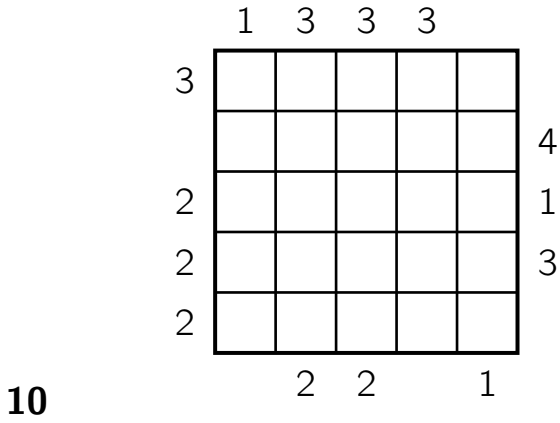
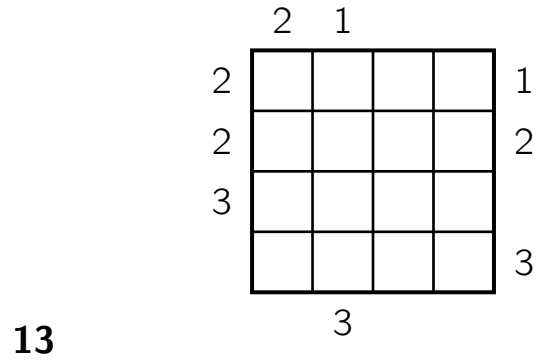
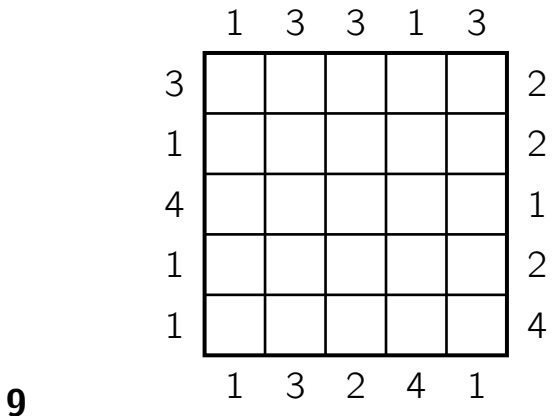

# Haltères

## Niveau 1

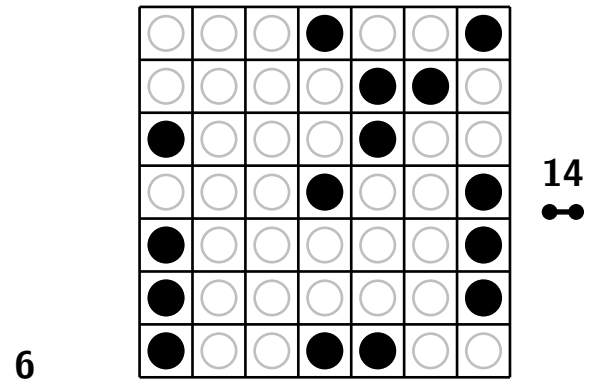
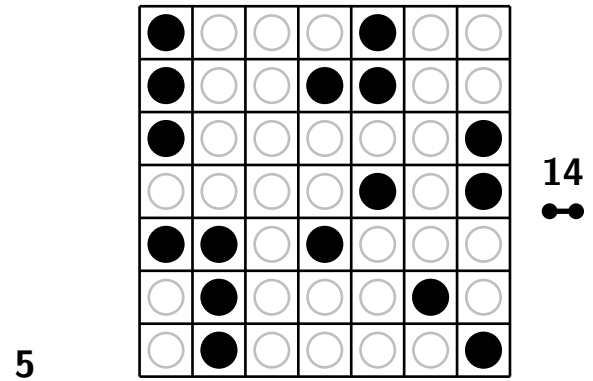
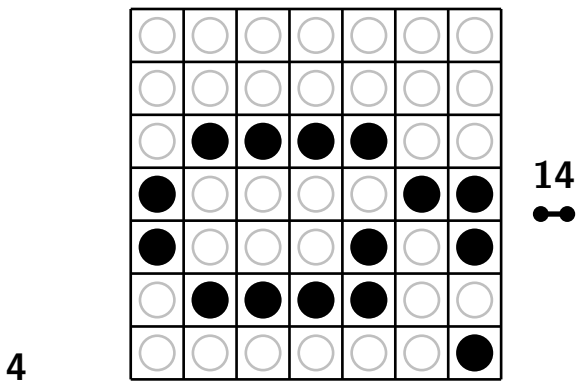
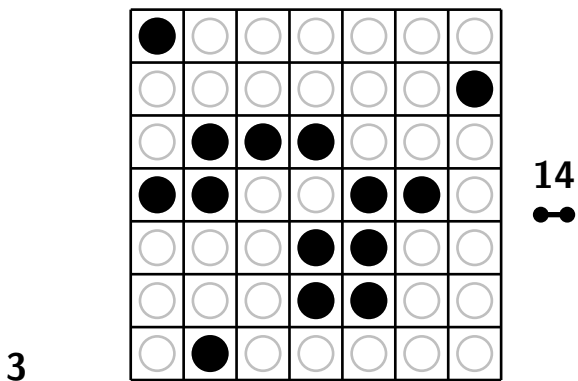
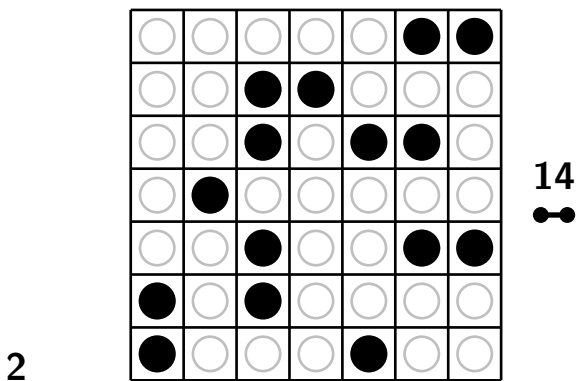
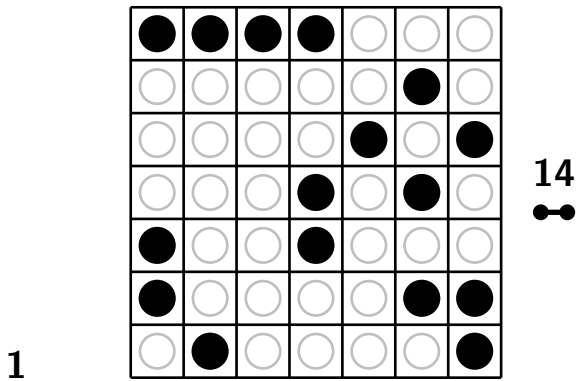

## Niveau 2

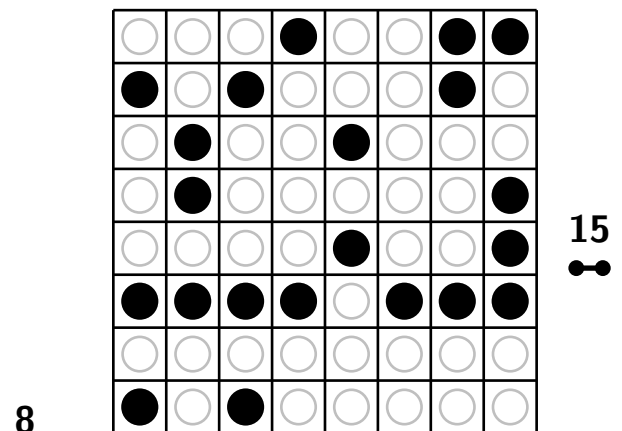
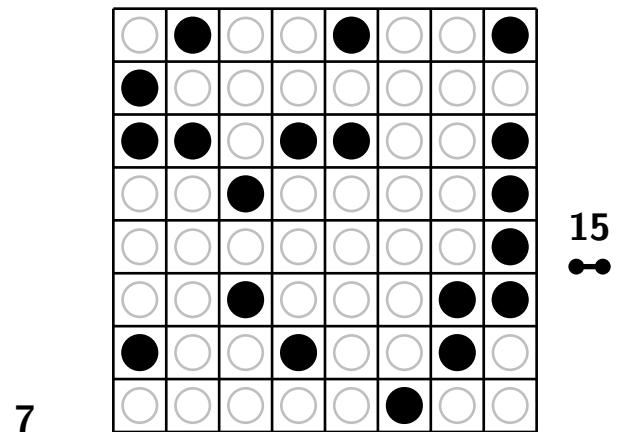



# Hamilton

## Niveau 1

1

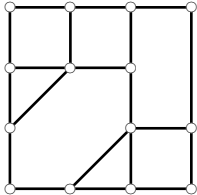

2

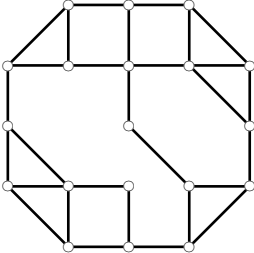

3

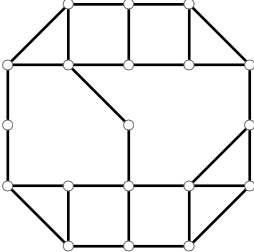

4

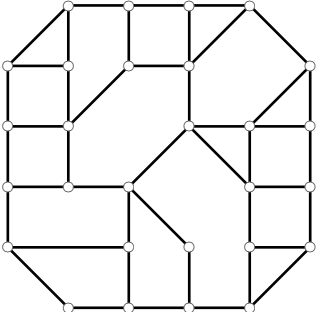

5

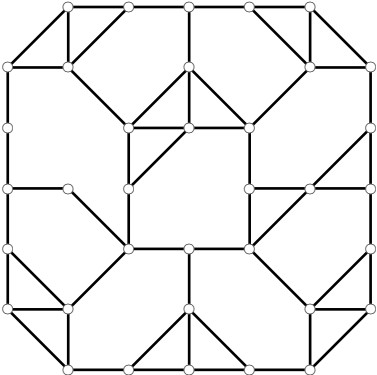

6

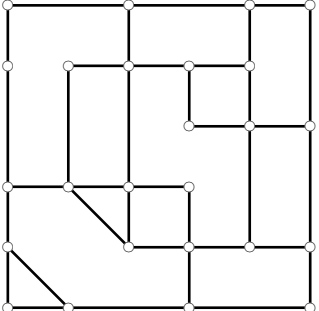

7

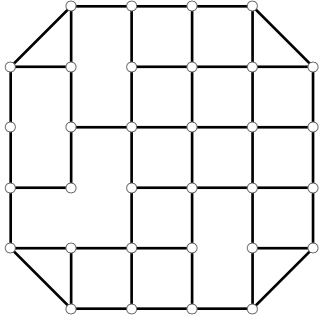

8

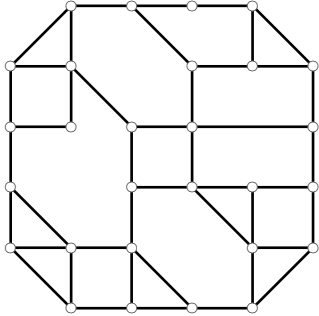

9

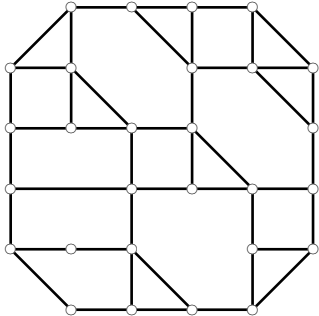

10

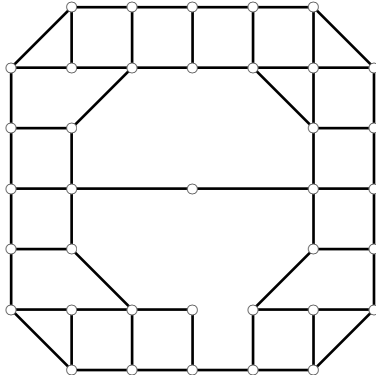

11

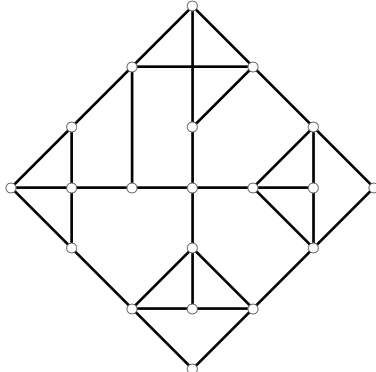

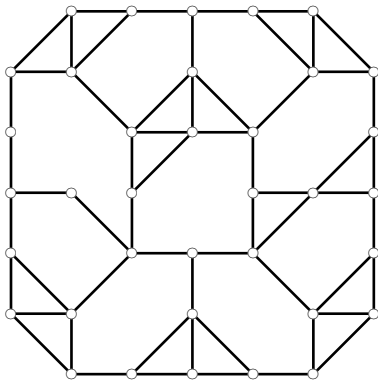

12

Niveau 2

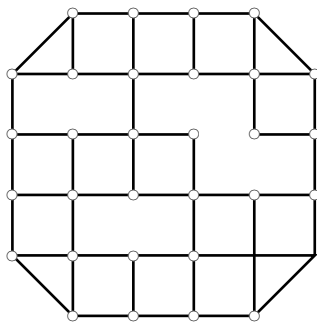

13

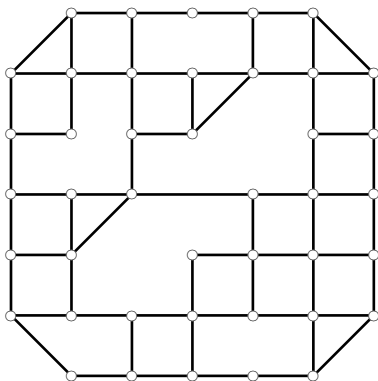

14

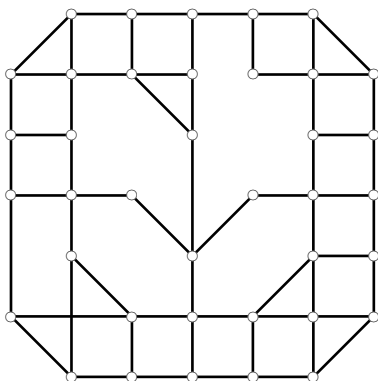

15

Niveau 3

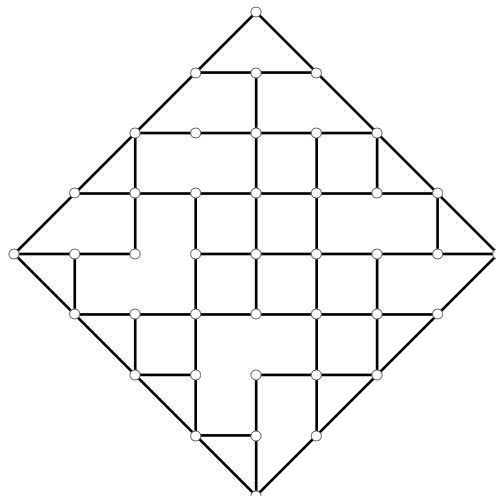

16

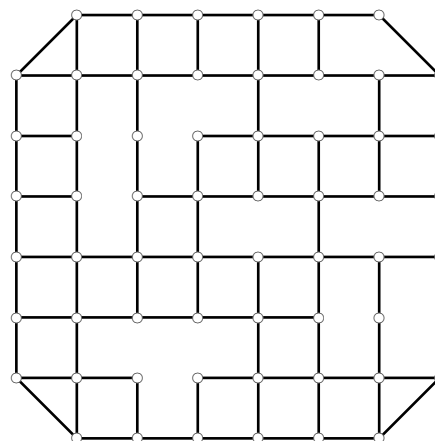

17

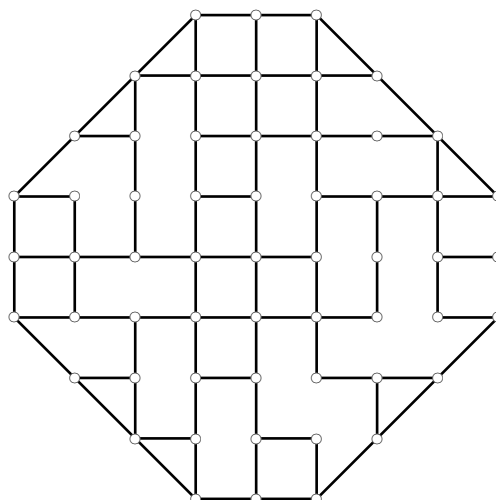

18

# Hanare

## Niveau 1

1

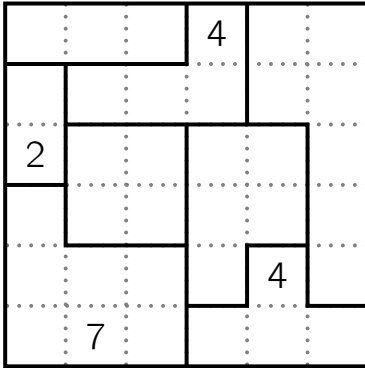

## Niveau 2

2

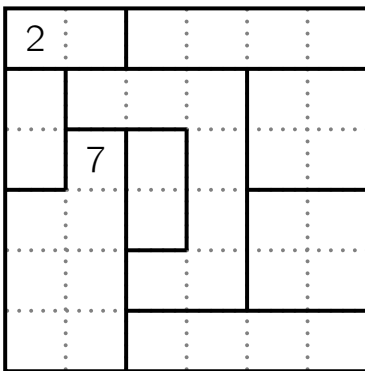

3

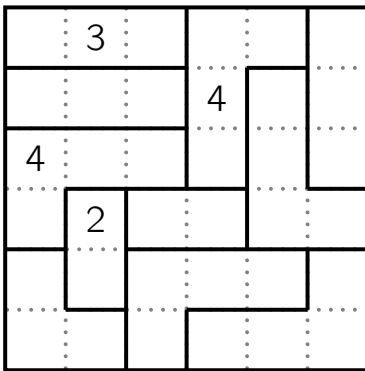

4

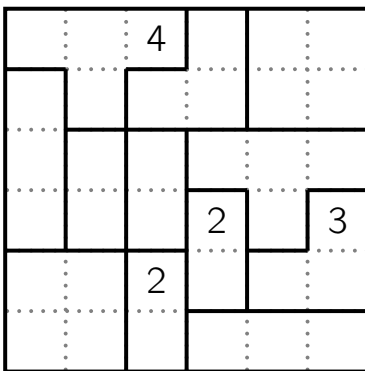

5

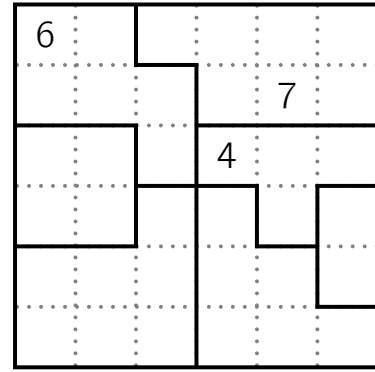

6

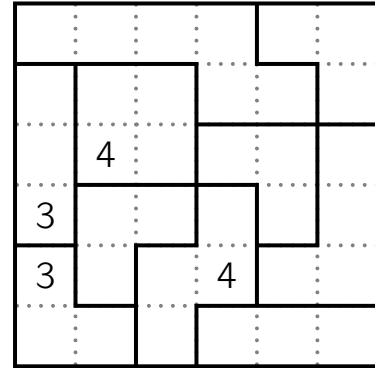

7

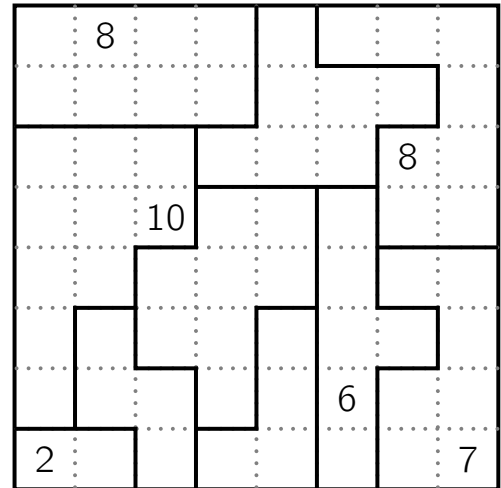

## Niveau 3

8

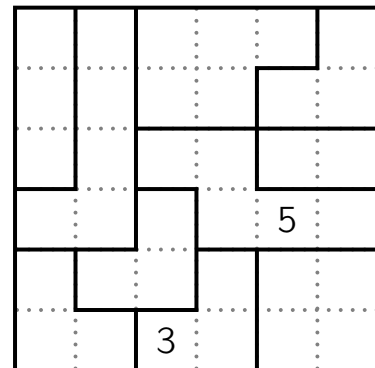



9

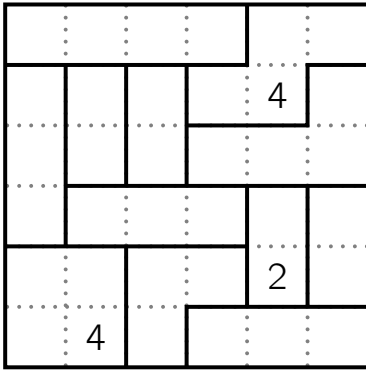

10

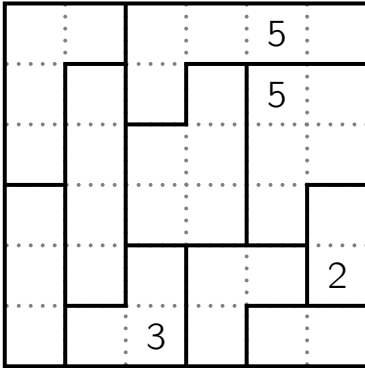

11

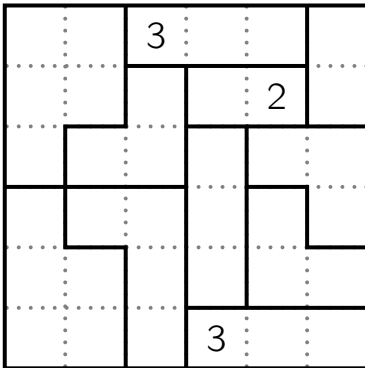

12

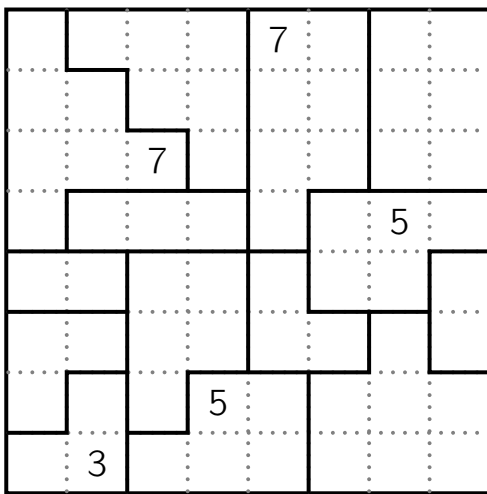

13

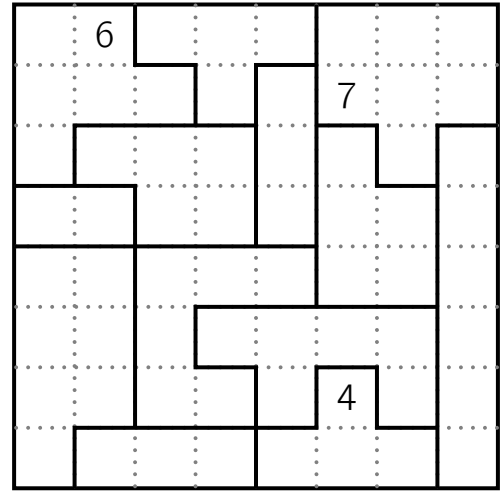

14

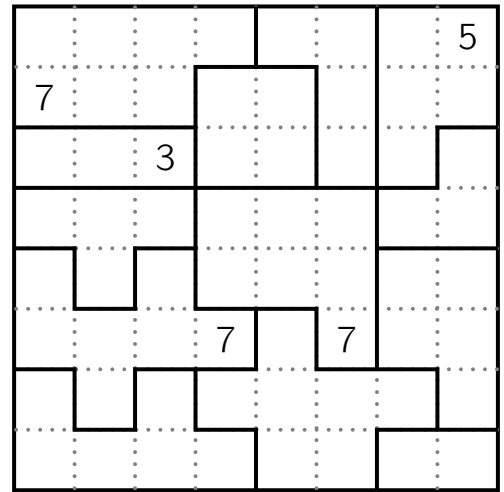

Niveau 4

15

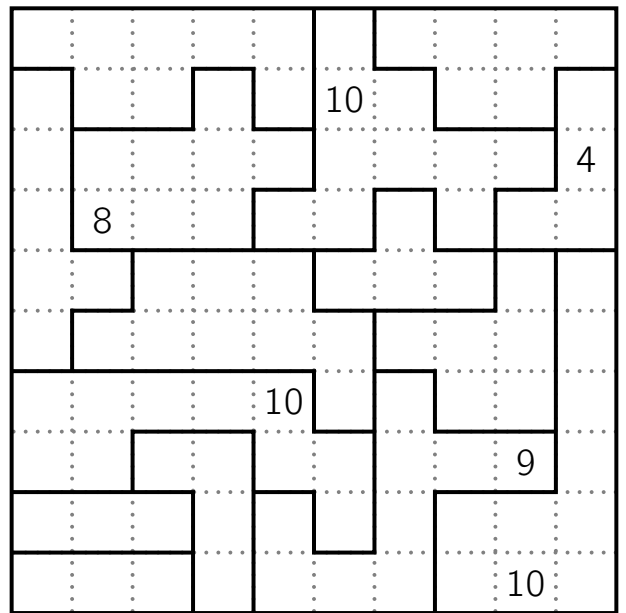

# Hidoku

## Niveau 1

1

9	8	7	18	14	16
35	36				4
	33			21	
		28	25	22	
		29		23	1

## Niveau 2

2

	31		36	2	
33		35			1
				5	
	21	24		27	
			13		8
	15	16		11	10

3

	1				
			23	16	
	4	25		18	19
9			27	21	
	8	36		32	31

4

1			30	29	
	34	32		27	
36	23	22			
20			15	13	

5

				36	
23	24		33		1
	21		31		
20					
	14	13			4
				7	5

6

					6
				4	
	1			15	8
	25			36	
		30		13	
	28	31			11

7

	20				24
			21	30	25
15				31	
			6		1
	9	34	33		
	10		36		4

8

		3		9	12
4					
29	27	31	1		16
					36
23	21			35	

9

1			4	22
	28	6		
30	27			20
	8		10	16
36				15
			12	

13

25		36			
	26	27		30	
				29	
	8	19		16	14
4			17		13
			1		

10

19					
	18		6		
		10		2	1
		9			32
15			30	31	
13			29		36

14

25					
		28	32		36
	21	23		14	
20					
	1				
2			6	7	10

Niveau 3

11

4		33			26
2					
	1	36			
			22	23	
	11		17		
10		12			20

15

	23		25	1	
32					3
	21			11	
	20			6	
	19				9
36			14		

Niveau 4

12

5	3		1		
		2			
					36
25				32	
	20			29	
	19	17			

16

	4		13		
					18
					19
		27	1		
30					23
	36		24		

# Hitori

## Niveau 1

1

1	3	5	5	1
3	4	1	2	1
1	1	5	4	3
4	1	2	2	4
4	5	3	1	4

2

2	1	1	4	4
3	1	4	5	2
2	3	4	2	2
5	2	3	4	1
5	5	4	1	2

3

2	1	5	4	4
4	1	4	5	2
5	5	2	4	4
5	2	4	1	3
4	4	4	2	4

4

2	4	2	1	1
2	5	4	2	1
4	3	4	5	2
5	1	2	3	2
4	2	4	4	3

5

5	5	3	4	3
3	4	5	1	5
5	4	1	1	4
2	1	4	3	5
4	1	3	4	1

6

3	5	2	1	2
2	2	3	3	5
2	1	5	2	3
4	3	3	5	2
5	1	3	2	2

7

2	3	1	2	6	6
3	2	6	3	5	6
4	5	3	6	4	2
2	1	6	6	2	1
6	4	5	2	3	1
3	4	2	3	4	2

8

2	2	5	5	1	1
5	1	3	6	5	4
5	5	3	1	3	2
2	5	5	1	6	1
1	4	2	3	5	2
3	4	1	3	4	5

9

4	5	3	3	2	4
4	6	2	2	5	5
3	3	2	4	1	6
1	6	4	4	6	4
3	1	5	6	4	2
4	4	5	3	5	4

10

3	6	2	3	1	5
6	5	1	5	5	6
2	3	6	5	4	1
4	1	1	4	5	2
3	5	4	1	2	6
1	5	5	4	3	1

## Niveau 2

11

5	5	3	1	3
2	5	1	1	3
5	1	1	2	5
1	4	5	3	2
1	3	2	2	1

12

5	3	4	4	1
3	1	3	4	5
3	5	1	1	3
1	1	5	3	2
1	2	1	5	1

13

2	4	1	4	2
3	2	2	5	1
3	3	5	5	4
5	4	3	1	2
2	1	1	3	2

14

3	1	4	2	4
5	3	4	3	5
2	3	2	4	5
4	5	3	1	2
1	1	2	2	3

15

5	5	3	4	3
3	4	5	1	5
5	4	1	1	4
2	1	4	3	5
4	1	3	4	1

16

5	1	4	1	5
4	5	4	1	3
2	4	1	5	4
1	4	5	5	2
5	1	3	4	2

17

6	1	2	2	5	1
2	1	3	1	3	6
4	3	2	5	6	4
5	4	1	3	2	1
5	6	1	5	3	2
3	3	5	6	2	4

18

1	6	1	3	3	6
3	5	1	1	6	4
6	3	4	6	4	2
2	4	3	4	5	3
6	2	3	3	4	1
5	4	6	5	6	3

19

1	6	2	4	2	5
1	2	1	4	5	4
5	2	4	3	6	1
6	3	5	1	4	1
2	2	6	5	2	3
5	5	3	3	2	6

20

1	5	3	2	4	3
1	2	3	2	1	4
6	1	2	3	2	5
3	4	2	6	4	1
5	3	5	3	6	4
5	6	1	4	1	2

# Kakkuru

## Niveau 1

1

	3	5		
4	6			
		7	4	
5				1

2

	5		3	
3		8		
5	6			
		4	3	

3

	3	5		
3	6			
5				5
		4	1	

4

		5	2	
4		8		
3	6			
	5		4	

5

		3		
	8		4	
3	6			
1		6		

6

		11		
7				
	15			
			4	

7

			6	3
	14	11		
		9		7
6			12	
1	4			

8

		7	9	
4	7			
6		13		
			9	6
	11			1

9

			7	5
7		12		
6			12	
	11	9		
	8			4

10

	4	6		8	
	10			8	3
			10	9	5
6	11	9			
5			10		9
5		8	6		

11

	4	5	7		
4	9			9	
3				10	4
6	8	10			
		7	8		6
			4	3	3

## Niveau 2

12

			9	5
4	10			
4			14	
	11	9		
		6		4

13

	6		11	
4	10			
6				9
		10	7	
		4		4

14

		4	6	
	10	7		
	11			7
6			12	
3				4

15

	4	5	7		
4	9			9	
3				10	4
6	8	10			
		7	8		6
			4	3	3

16

		14		
9				
			20	
	22			
				4

17

	7	6			2
			10	11	6
6	11	10			
4			10	10	
	11		8		6
5		5		6	

18

		7	6		4
6	7			11	
	6	8			8
5			10	8	
6			8		5
	8	7		4	

## Niveau 3

19

		6	5	
	13			5
6				7
5		12		
	5		8	

20

		9	7	
7				7
	9		13	
7		9		
	7			5

21

	11			
				16
		19		
14				
			9	

# Kakurasu

## Niveau 1

1

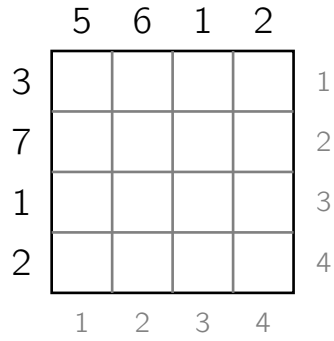

2

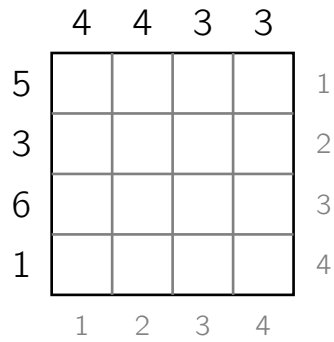

3

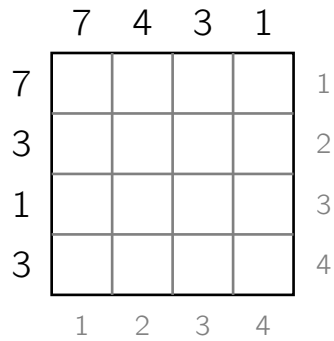

4

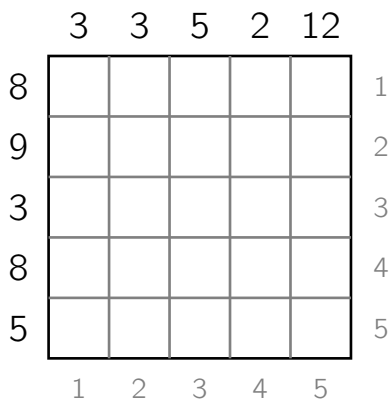

5

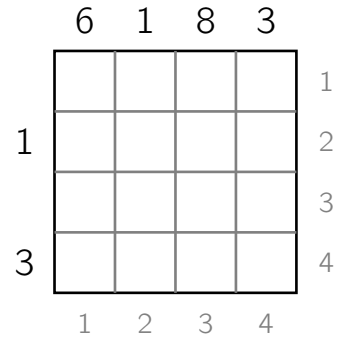

6

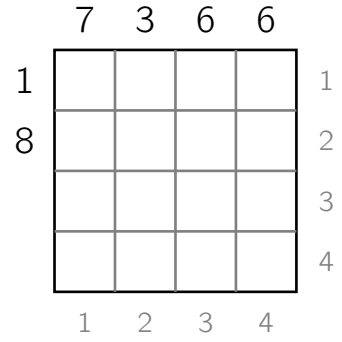

7

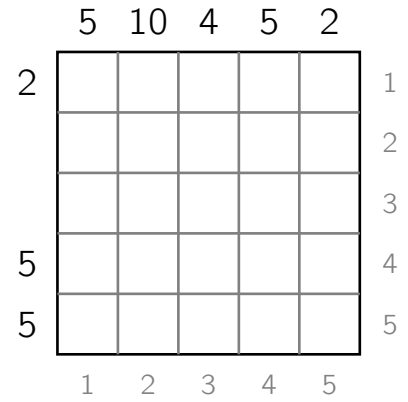

## Niveau 2

8

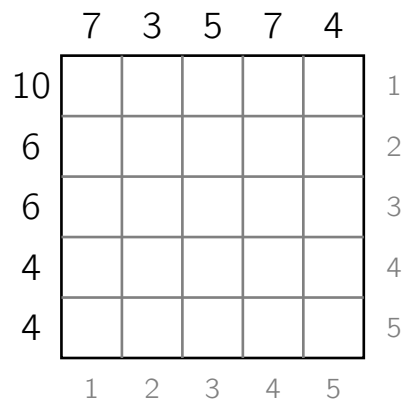



### Niveau 3

9

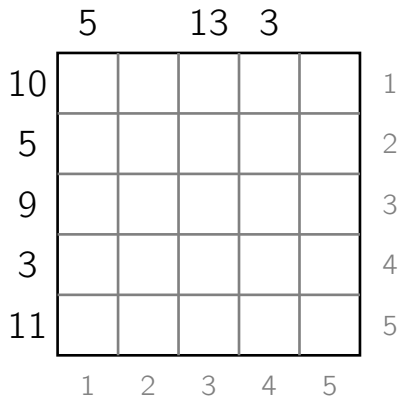

10

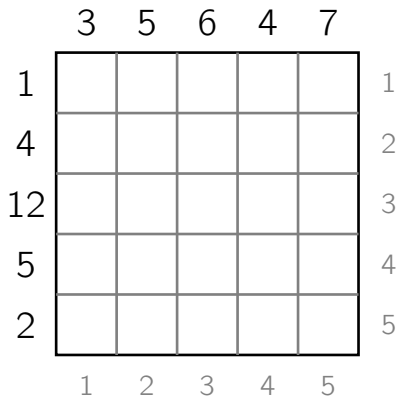

11

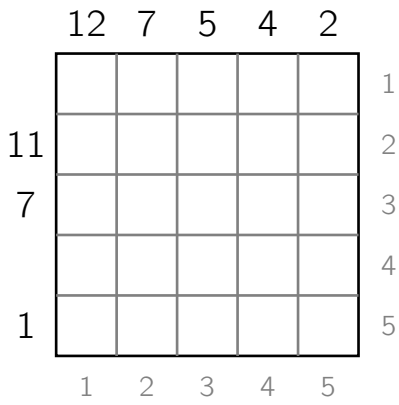

12

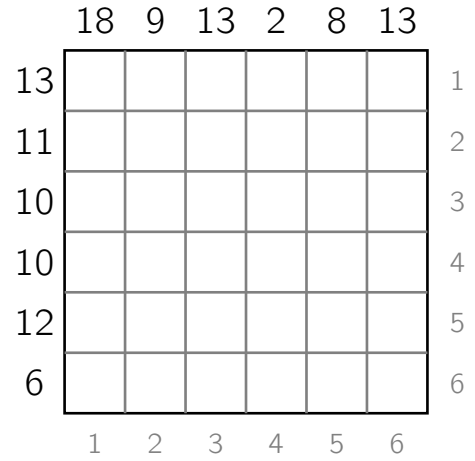
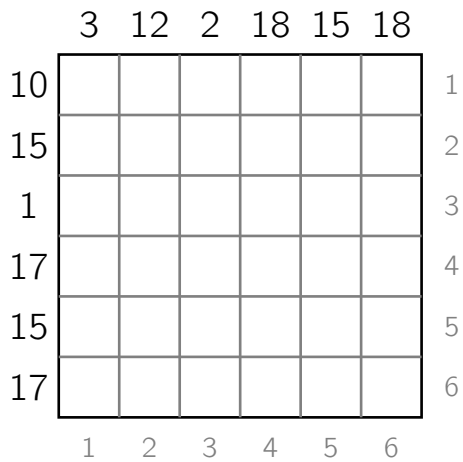

13

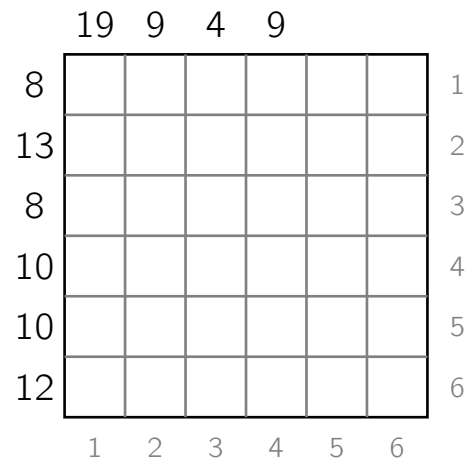

14

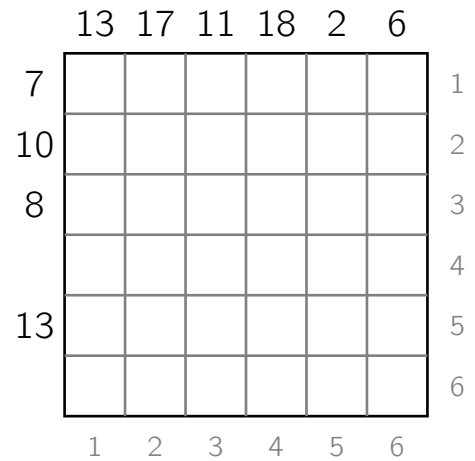

15

# Knossos

## Niveau 1

1

				8	6
		8	6		
8	6		8		
8		8	6		4
6				4	6
	6			6	

2

	4				8
			14	4	
	4	14			4
			4	10	
		4	12		8

3

6	8				6
	8				10
12		10			4
4					
		4		4	
				12	10

4

				8	6
			14	6	
6	14				4
10					
6			6		10
					6

5

12	12	10			4
		4			
					6
		6			4
4		6	12	10	
				6	

6

		10	4		6
			12		
	8	4		14	
	10			4	
	8	12			

7

	6	8					
		8		6		8	6
			6	8			6
	4	8	8	4			6
10	6						8
	6		4		8		
8	4						8
		8	6		6		8

8

4		10	8			10	6
		8					
			4				6
	6		8				6
	6			8		8	8
10		8			6	8	
	8		8				
	8	4		4		8	

Niveau 2

9

	8	6			
12		6			
				8	8
	4	8		8	4
	6		6		
				12	

12

					4
	8				10
4				12	4
	4	10			
	8	8			8
6			6	6	

13

	8	12			
		6		14	
	10		4		
6					6
	6	12	4		
			6		

10

	6	8	4			6	
			6		4	6	
		6		8	8		10
4	10		4	12			
8		6			10		
10		6					
	6		4	6		6	
				8	8		

14

8							8
					10		
		6	6		6		
	10		8				
		8	6	10			4
10	8			6	8		
		6	4				

11

			8	6				8	6
6		4		6		6		6	
8				8	6	8		6	
6	8			8		6			4
				6	4		4	8	
6		6		4		6		6	4
6		6			6			8	
8			8	8			8		
4							6	6	6
	8	6	6		4		6		6

15

	10					6	
8	8				8		8
	6						4
	4		4	8	6		
		8	10		8		
8		4	6		8	10	
8	10						
					8		6

# Kuromasu

## Niveau 1

1

4				2
	6			
	3			

2

5				
		3		
				4
			3	

3

5				
		7		6
	6			
	5			

4

				2
4				
		3	5	

5

2			6	4
	4			
			4	

6

	6			
2		3		
				6
			2	

7

	5			
2				4
	3		6	

8

	3	4		2
5				
	2			

9

		2		
5			3	
4				
				4

10

		2		
3	7	4		

11

				5
		5		
	2			
		4		

12

3	4		5	
				5
	4			

13

		2		
			8	
4	7	5		

14

			3	
5	7		7	
			5	

15

	5	4		
			7	
		5		5

Niveau 2

16

		3			
2					
3					
					2
		6	4		

17

4				3	
7					5
		4			
	4				

18

	3				
6		4			
			7		
				3	5

19

	7				
				6	
			2		
					6
3					
				4	

# Magnets

## Niveau 1

**1**

+	2	2	1	2	2	2	
3	□	□	□	□			3
1	□		□	□			1
2	□	□	□	□	□		2
3	□	□	□	□			3
2	□	□	□				2
	2	2	2	1	2	2	—

**2**

+	2	1	2	1	0	2	
3	□	□	□	□			1
1	□	□	□				3
2	□	□	□	□	□		1
2	□	□	□	□	□		1
0	□	□	□	□			2
	2	1	1	2	0	2	—

**3**

+	1	1	1	1	3	2	
2	□	□	□	□	□		2
1	□	□	□	□	□		1
2	□	□	□	□			2
3	□	□	□	□	□		1
1	□	□	□	□	□		3
	2	0	0	2	2	3	—

**4**

+	1	3	2	1	2	2	
2	□	□	□	□	□		3
2	□	□	□	□			1
3	□	□	□	□			3
3	□	□	□	□			3
2	□	□	□				2
	3	1	2	1	3	2	—

**5**

+	2	3	2	3	3	4	2	1	
4	□	□	□	□	□	□			4
4	□	□	□	□	□	□	□		3
3	□	□	□	□	□	□	□		4
2	□	□	□	□	□	□	□		2
2	□	□	□	□	□	□	□		2
2	□	□	□	□	□	□	□		2
3	□	□	□	□	□	□	□		3
	3	3	2	2	4	3	3	0	—

**6**

+	3	3	1	1	1	3	3	3	
3	□	□	□	□					3
4	□	□	□	□	□	□			3
0	□	□	□	□	□	□	□		1
4	□	□	□	□	□	□	□		2
2	□	□	□	□	□	□	□		3
3	□	□	□	□	□	□	□		2
2	□	□	□	□	□	□	□		4
	4	2	2	1	1	2	3	3	—

**7**

+	2	3	3	3	3	2	3	4	
1	□	□	□	□	□				1
4	□	□	□	□	□	□	□		3
3	□	□	□	□	□	□	□		4
4	□	□	□	□	□	□	□		4
4	□	□	□	□	□	□	□		4
3	□	□	□	□	□	□	□		4
4	□	□	□	□	□	□	□		3
									—

## Niveau 2

$+$  2 2 2 0 1 2  
 3    3  
 1     1  
 1     1  
 1     3  
 3     1  
**8**      1 2 2 1 1 2  $-$

$+$  1 2 2 1 1 3  
 3     2  
 1      2  
 2      1  
 1      1  
 3      3  
**9**      1 2 2 1 2 2  $-$

$+$  3 1 2 2 2 2  
 3       3  
 3       3  
 3       3  
 2       2  
 1       1  
**10**      1 3 2 2 2 2  $-$

$+$  2 0 1 2 1 3  
 2     2  
 1      2  
 2      1  
 1       2  
 3       2  
**11**      2 1 1 1 2 2  $-$

## Niveau 3

$+$  1 3  
    
 2        
 2       3  
 2       3  
**12**      1 1 2  $-$

$+$  1 0  
   2  
     2  
 2       3  
 1        
 2        
**13**      0  $-$

$+$  1 2  
 3     2  
      1  
 2       1  
 0        
 3       2  
**14**      2  $-$

$+$  0  
 1     1  
      1  
 1       2  
      2  
       
**15**      1 2 2 0  $-$

# Marguerite

1

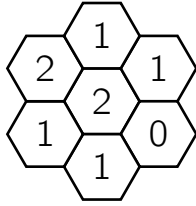

2

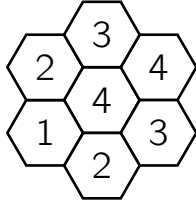

3

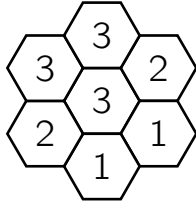

4

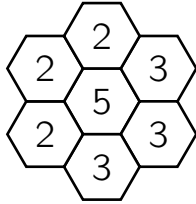

5

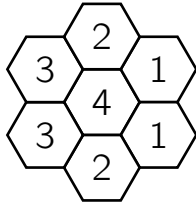

6

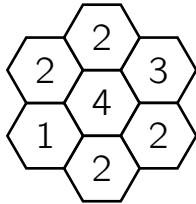

7

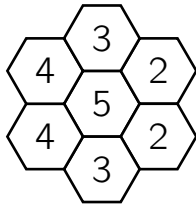

8

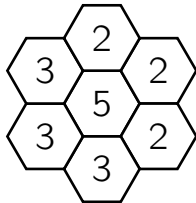

9

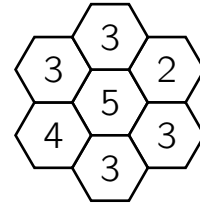

10

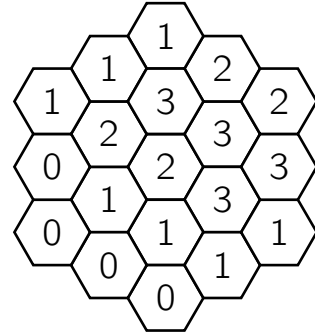

11

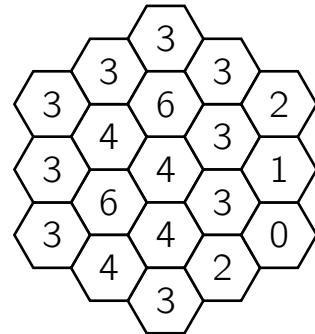

12

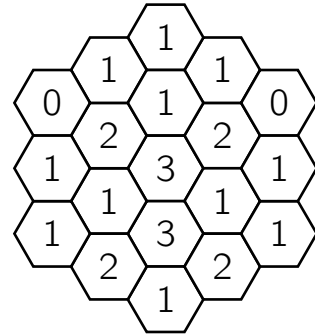

13

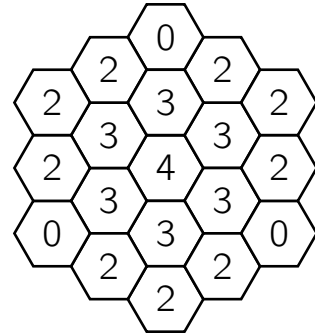



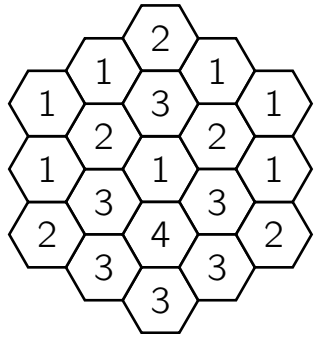

14

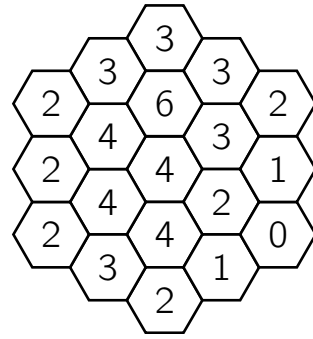

19

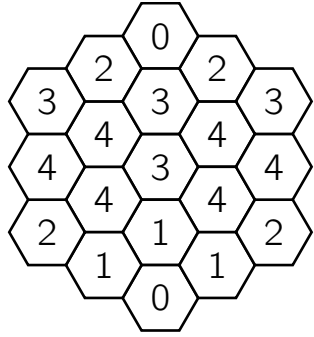

15

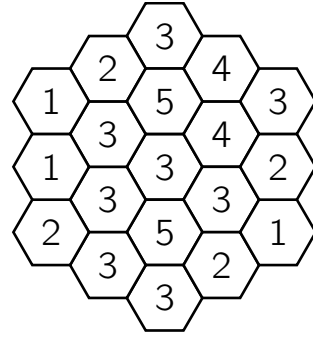

20

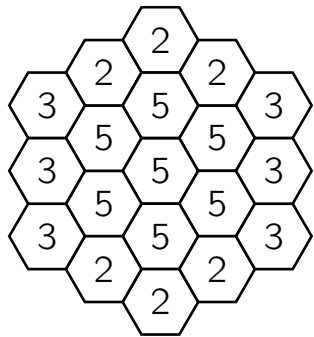

16

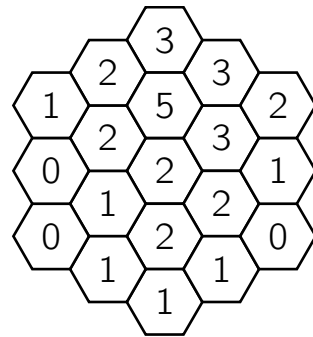

21

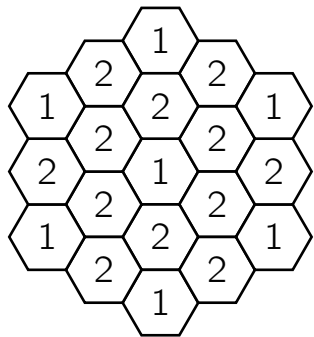

17

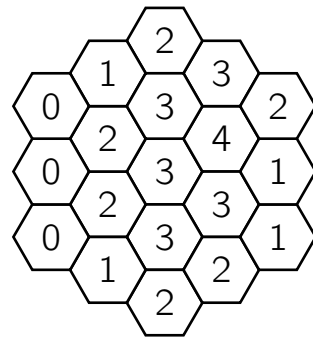

22

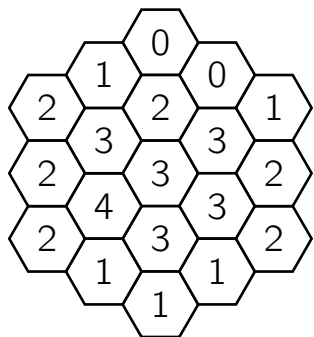

18

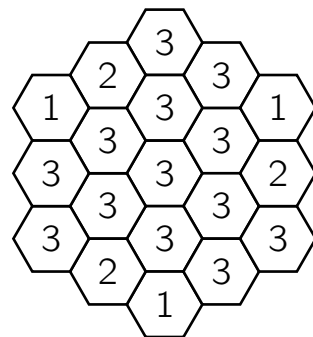

23

# Master Mind

## Niveau 1

**1**

3	1	4	●	1	○	1
2	2	4	●	0	○	2
5	3	2	●	1	○	0
<hr/>			●	3	○	0

**2**

3	6	5	●	0	○	1
4	1	6	●	0	○	2
5	1	3	●	0	○	1
4	3	2	●	0	○	1
<hr/>			●	3	○	0

**3**

5	5	5	2	●	1	○	2
5	3	5	2	●	0	○	3
6	4	5	2	●	1	○	2
<hr/>				●	4	○	0

**4**

1	3	6	4	●	2	○	2
3	1	4	3	●	0	○	3
3	4	1	3	●	0	○	3
1	1	3	4	●	0	○	3
<hr/>				●	4	○	0

**5**

4	1	2	6	●	2	○	0
3	4	6	5	●	2	○	0
3	2	3	6	●	2	○	0
5	1	6	4	●	2	○	0
<hr/>				●	4	○	0

**6**

3	2	3	5	●	2	○	0
1	1	6	3	●	2	○	0
4	6	6	5	●	2	○	0
1	2	4	4	●	2	○	0
<hr/>				●	4	○	0

**7**

2	5	6	4	●	2	○	0
1	3	1	6	●	2	○	0
3	5	1	2	●	2	○	0
1	6	2	4	●	2	○	0
<hr/>				●	4	○	0

**8**

6	1	5	6	●	0	○	2
2	2	1	4	●	0	○	2
4	5	4	3	●	0	○	2
3	6	3	2	●	0	○	2
5	4	6	1	●	0	○	2
<hr/>				●	4	○	0

## Niveau 2

**9**

1	8	2	6	●	0	○	1
2	4	8	3	●	0	○	2
5	7	4	1	●	0	○	2
2	3	7	5	●	0	○	2
3	6	5	7	●	0	○	3
<hr/>				●	4	○	0

**10**

2	1	3	8	●	0	○	1
6	5	1	4	●	0	○	3
1	3	7	8	●	0	○	2
5	8	4	6	●	0	○	2
7	4	5	6	●	0	○	3
<hr/>				●	4	○	0

**11**

4	1	6	1	●	0	○	3
1	6	1	5	●	2	○	1
1	5	4	4	●	3	○	0
<hr/>				●	4	○	0

**12**

2	3	5	5	●	0	○	3
3	5	2	5	●	2	○	1
2	4	5	1	●	0	○	3
1	5	2	5	●	2	○	1
<hr/>				●	4	○	0

**13**

2	5	2	4	●	1	○	2
4	2	3	5	●	0	○	4
4	6	3	2	●	1	○	2
<hr/>				●	4	○	0

**14**

3	2	5	1	●	1	○	2
2	6	5	2	●	1	○	2
2	5	3	1	●	3	○	1
1	1	2	2	●	1	○	2
<hr/>				●	4	○	0

**15**

6	3	2	2	●	1	○	2
5	1	3	2	●	1	○	2
5	2	2	2	●	2	○	1
<hr/>				●	4	○	0

**16**

3	1	3	5	●	1	○	2
6	3	3	1	●	0	○	3
6	2	5	3	●	2	○	1
<hr/>				●	4	○	0
6	4	5	2	●	1	○	3
1	6	2	4	●	0	○	3

**17**

4	3	6	5	●	2	○	1
1	2	4	5	●	1	○	2
<hr/>				●	4	○	0

**18**

1	2	3	●	1	○	0	
1	4	7	●	0	○	1	
4	5	6	●	1	○	0	
2	5	8	●	0	○	1	
7	8	9	●	1	○	0	
3	6	9	●	1	○	0	
<hr/>				●	3	○	0

**Niveau 3**

**19**

6	2	3	4	●	1	○	0
7	1	2	6	●	1	○	0
3	7	6	8	●	1	○	1
5	6	1	2	●	1	○	1
<hr/>				●	4	○	0

**20**

5	5	5	5	●	1	○	0
6	5	2	1	●	2	○	1
1	2	3	4	●	1	○	1
3	4	6	2	●	0	○	1
<hr/>				●	4	○	0

# Meadows

## Niveau 1

1

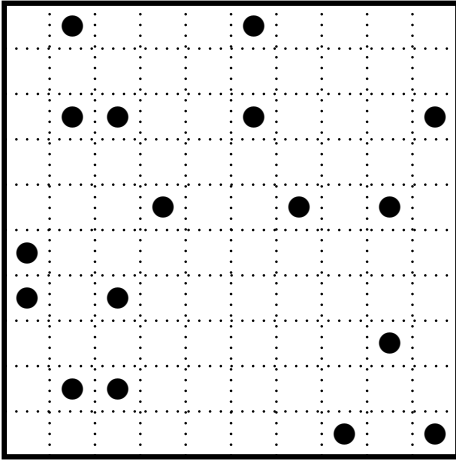

2

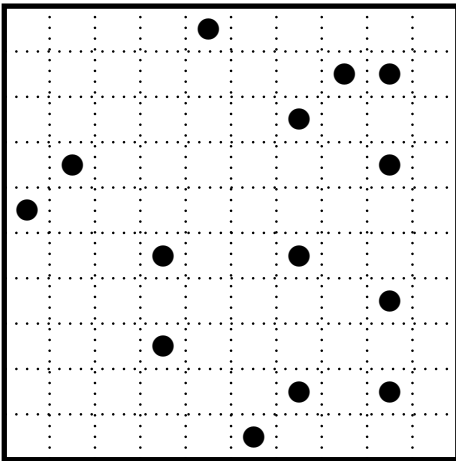

3

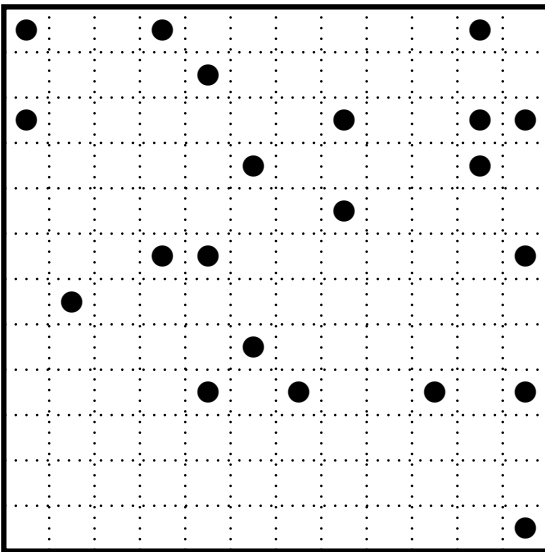

4

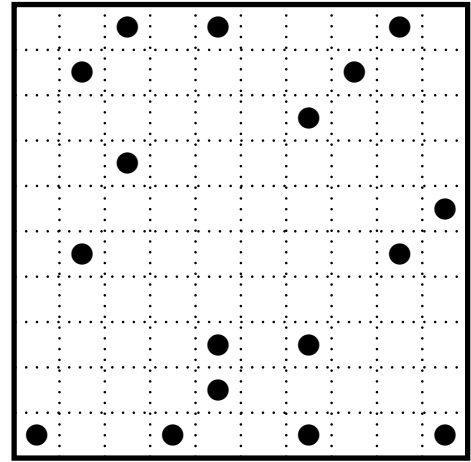

5

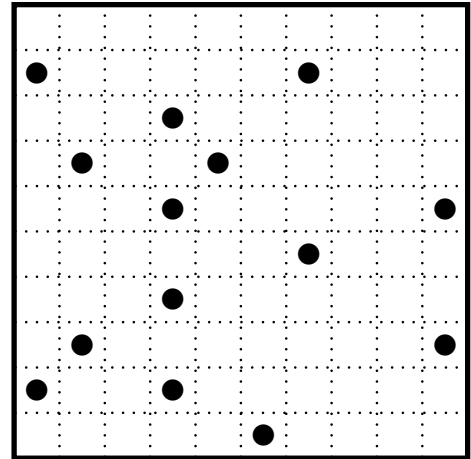

6

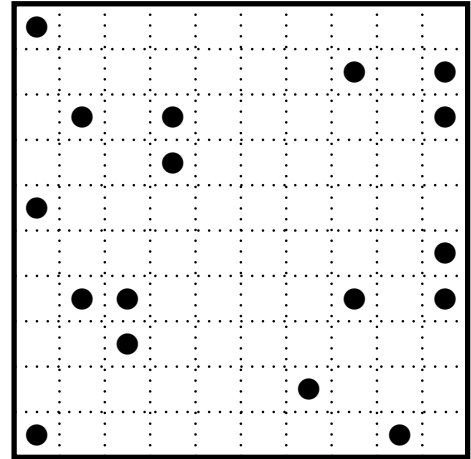

7

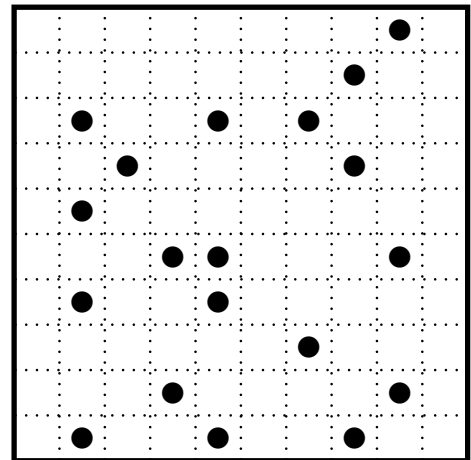

8

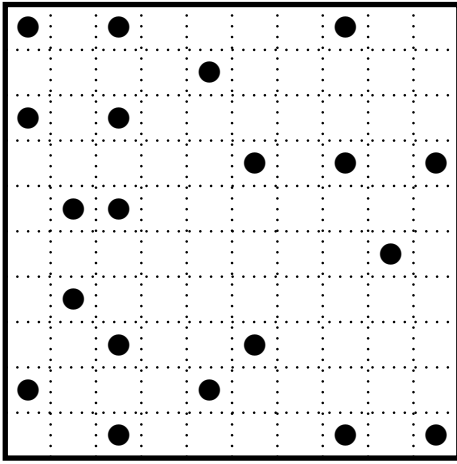

11

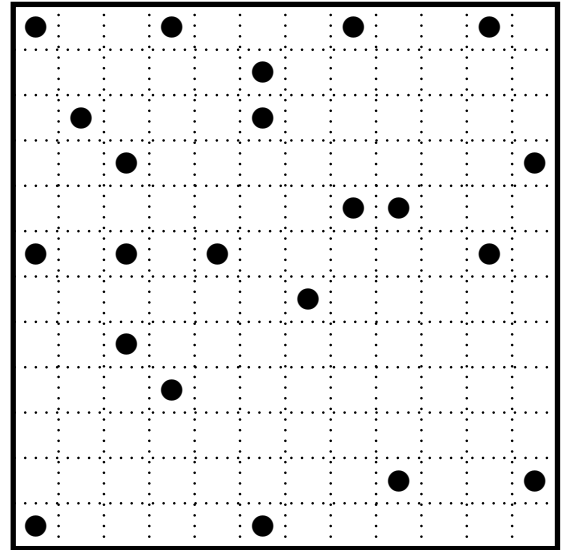

9

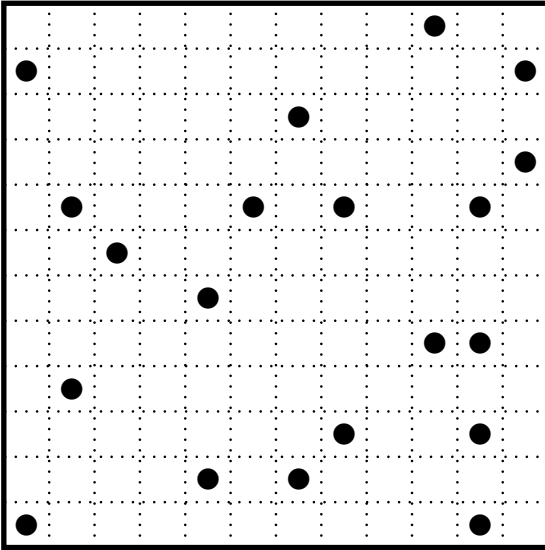

12

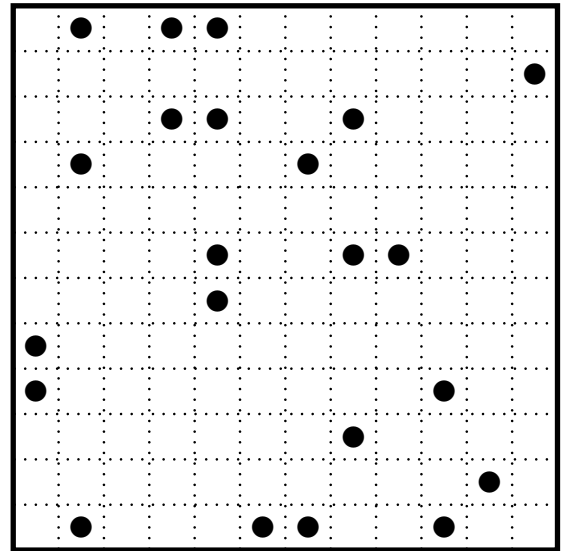

Niveau 2

10

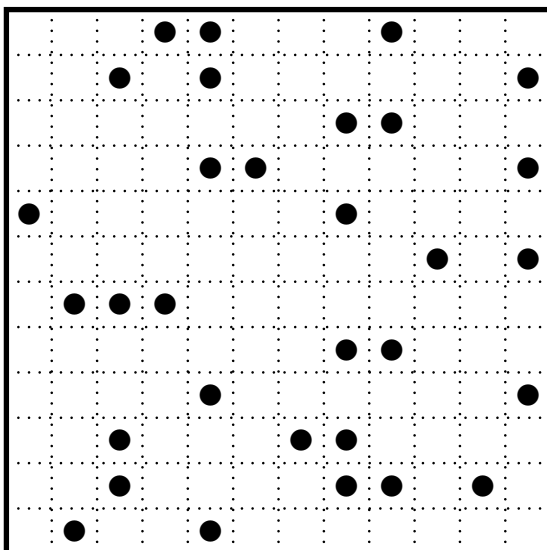

13

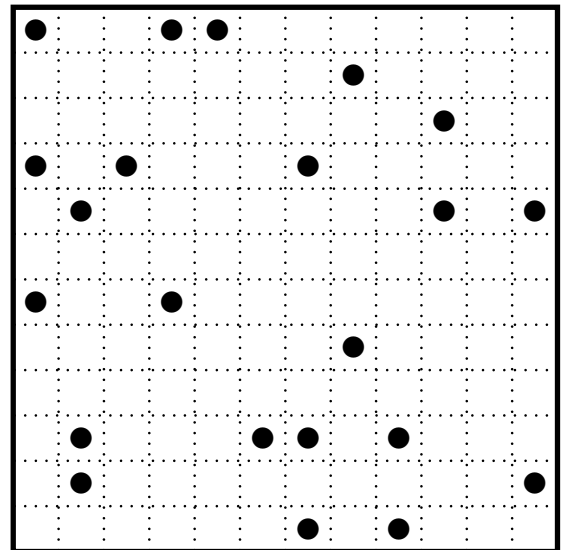

# Météo

## Niveau 1

1

			0	
		1		
2		2	2	
0		2		

2

		2		
		2		
2				
	2			
0			2	

3

2		2		1
		2	2	
1				
0			2	

4

		2		
		0		
0				

5

		2	2	
1		2		
0				2
		1		

6

			1	2
		2		
				2
		2		

7

			2	1
	1		2	
		0		1

8

			2	
2		2		
	2		1	
1				1

9

0				
			0	
			1	
		2		

10

1		2		
		0		
2	1			

11

		2	2	2
	2			1
			1	

12

		2	2	2
	2			1
			1	

Niveau 2

13

		2		0
0				
		1	2	
		1		2
0		1		

14

			0	0
		0		
2		2	2	

15

	1			2
			2	
2				0
2	2	1	2	
			2	

16

				1	2
2					
2		2	1		
	0				

17

1					1
		2			
				2	2
	2			2	
					1
1				2	1

18

2					1
1	1				
2		1		1	1
			2		
	1		2		1

19

2			1		
	1	1			
2				0	
			2		
				2	
0					

20

				2	
	2				2
		2	2		1
			1		
	2	1			

# Mintonette

## Niveau 1

1

?		3		2	4
1	5				
	2			4	
		5			
	2			1	
		2	2		
	1	2			1
4					4

4

1	1					2		
		2		4	4	2	2	
		2	1					
				1	2	2	2	3
1							2	
			5		2	2		2
	1	5	1	1				
	1	1		1			5	1
1				5	1			
4		4						3

## Niveau 2

2

3		1		2	4	4
			2			
	1					
	4	1	?	1		
					3	1
3			?		3	3
1		4	?			
	1					3

5

1				3		3	1
3	1	4	4		1		
				1			2
2	2		3	4		2	1
		1		4			
		5				2	4
		2	1			3	2
				1			4
	2		3		1		
5			4				4

3

1		1	?		4
	?	4	2		4
	1			2	
4		?	5		
		?			?
	1				
1	1		5	?	
1		2			

6

1	1	2	3	1		
	1	4	2		1	
	4	1			1	
	1			4	3	
	1	1	3	3	1	1
4	1		1	1		3
		1	2			
	4		1	3		2
	2	1	3		2	2
	4	2				3



7

3		1	1	2		1	
	1	1			2		5
	3				1		1
		2	1	2		1	
		3			1		
	3	?				?	
		2		?			
4			4		3	5	
			3			2	
?	2					2	2
							5

10

	1	3					3
						1	
1	1	2					2
		2				?	
	2	4					
?				1		5	5
?		5					
		?					5

Niveau 3

8

4	3			3		4	
			2	4	2	1	
					1		
	?	2			2	4	
	2						
					5		
5			3				3

11

1		1					1
5	1		?			2	?
			3	1	3		5
							?
	5		3	2	1		
					1		1
		5	?	1	1	1	5
?						3	3
		1				1	
3			3	1			1

9

2			?		3		1
5	?		1			5	
	5			5			
			1		4	1	1
						1	?
						?	
			3			4	
	3		1		4		
	3				1		
				?			1

12

1		1		1			2
1		?		3			?
	1			1		1	3
	2	5		1	?		2
					5	?	?
	1	3	2			1	
	1			5		1	
		2					?
		3			?		1
1		2	5		4		1

# Miroirs

## Niveau 1

1

	2	0	0	3	
1		/		/	1
1	/		/		0
1	/		/	/	1
2		/			2
	0	0	2	2	

1 4  
1 4  
1 0

2

	0	0	3	0	
1	/	/		/	1
1		/			2
1			/	/	1
1	/		/		2
	0	2	0	0	

1 4  
1 4  
1 0

3

	0	0	2	1	
0	/	/		/	3
2		/			1
0	/			/	0
2		/		/	0
	4	1	2	1	

0 4  
2 4  
0 0

4

	1	2	1	5	
0	/		/		3
0	/	/			3
5				/	1
3	/		/		3
	1	3	1	1	

0 0  
1 1  
3 8

5

	2	1	2	1	
0		/			4
1	/		/	/	1
5				/	1
1	/		/		4
	1	5	1	0	

0 3  
1 0  
1 6

## Niveau 2

6

	4	2	1	2	
5	/		/		0
1		/		/	5
3		/			2
0	/			/	0
	0	3	4	0	

0 3  
5 0  
0 6

7

	0	1	3	3	
0				/	3
1	/	/			3
2	/	/			2
1	/			/	0
	3	1	3	0	

0 3  
1 2  
1 4

8

	0	4	0	0	
0	/		/	/	0
4					4
1	/				3
2			/		3
	1	4	1	4	

0 1  
4 7  
2 3

9

	1	3	1	3	0	
1			/		/	0
0	/			/		1
1	/		/		/	3
1		/				2
	0	1	1	2	4	

0 6  
1 6  
2 0

10

	1	3	1	1	3	
0	/		/	/		1
3	/		/		/	3
1	/			/		1
2		/	/		/	1
1		/		/		3
	2	0	2	0	1	

0 0  
1 6  
3 6

### Niveau 3

11

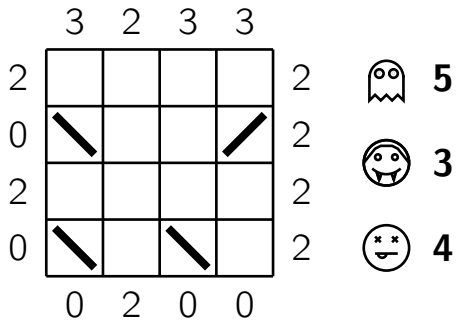

12

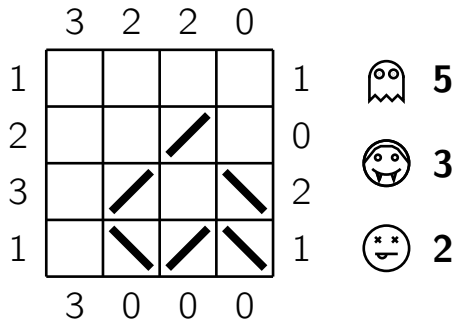

13

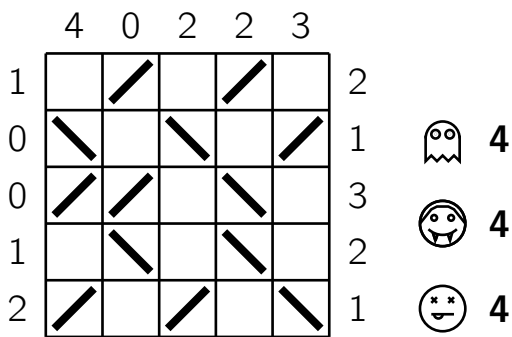

14

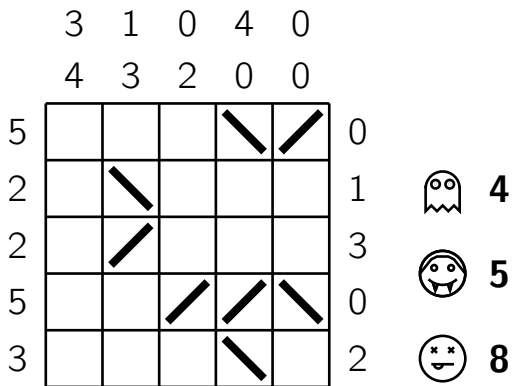

15

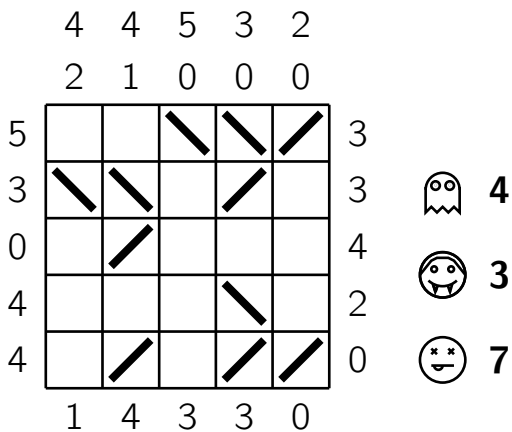

### Niveau 4

16

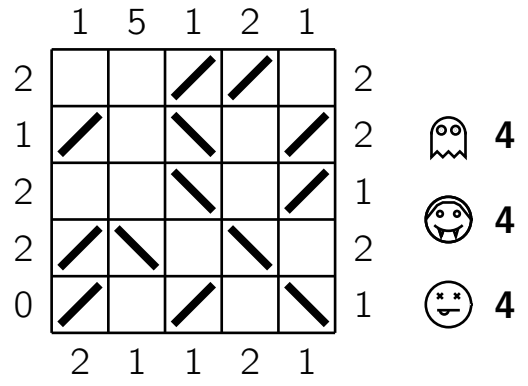

17

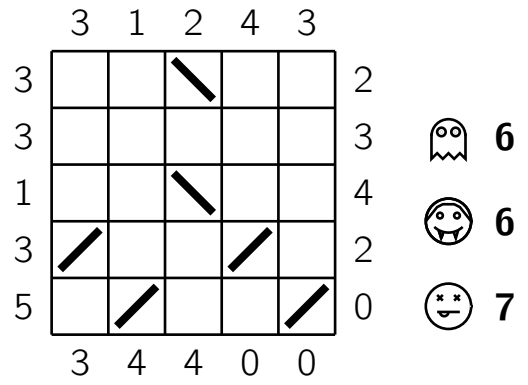

18

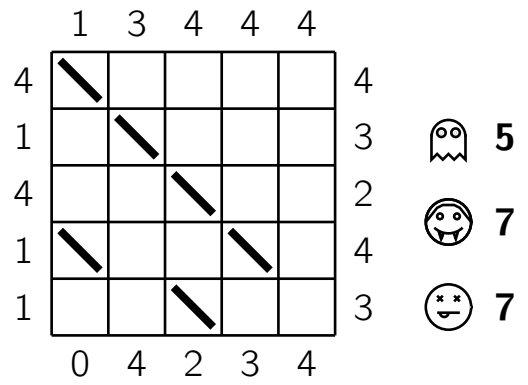

# Morphism

## Niveau 1

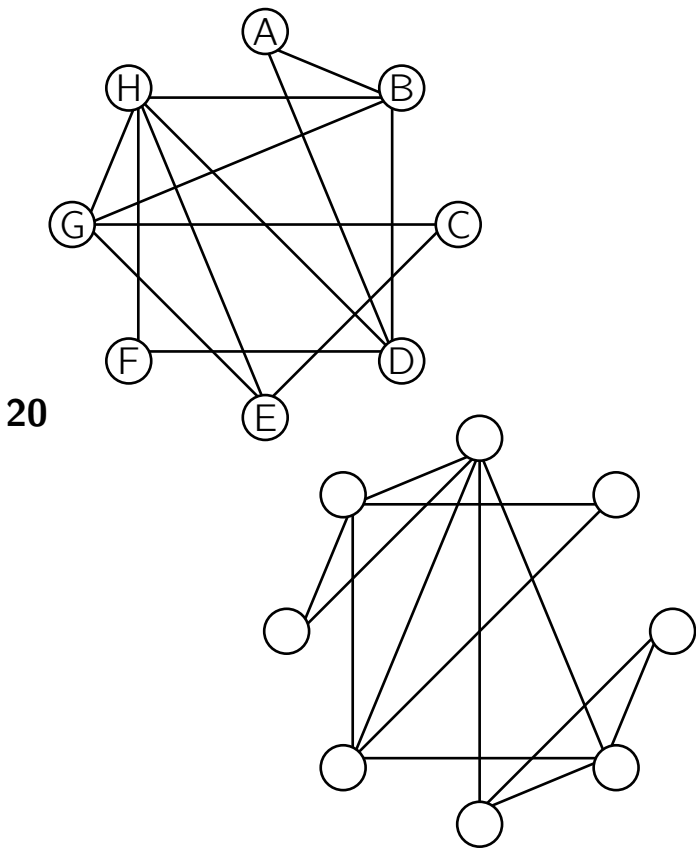
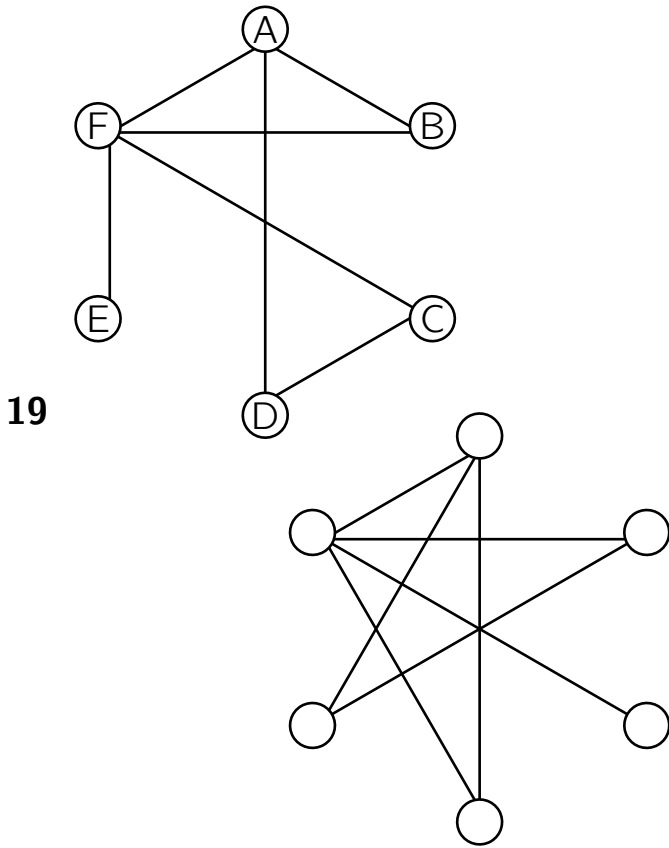

## Niveau 2

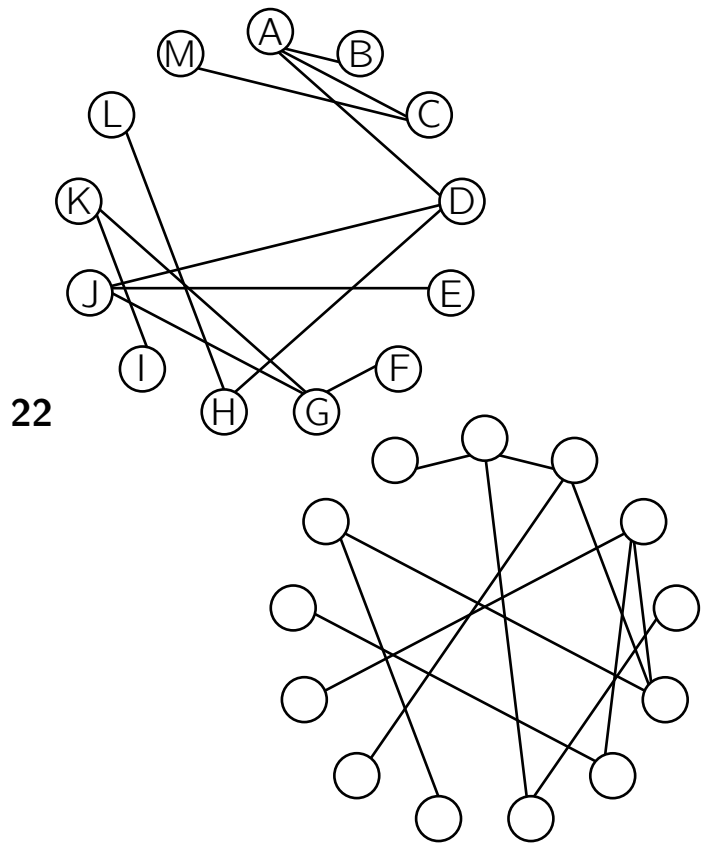
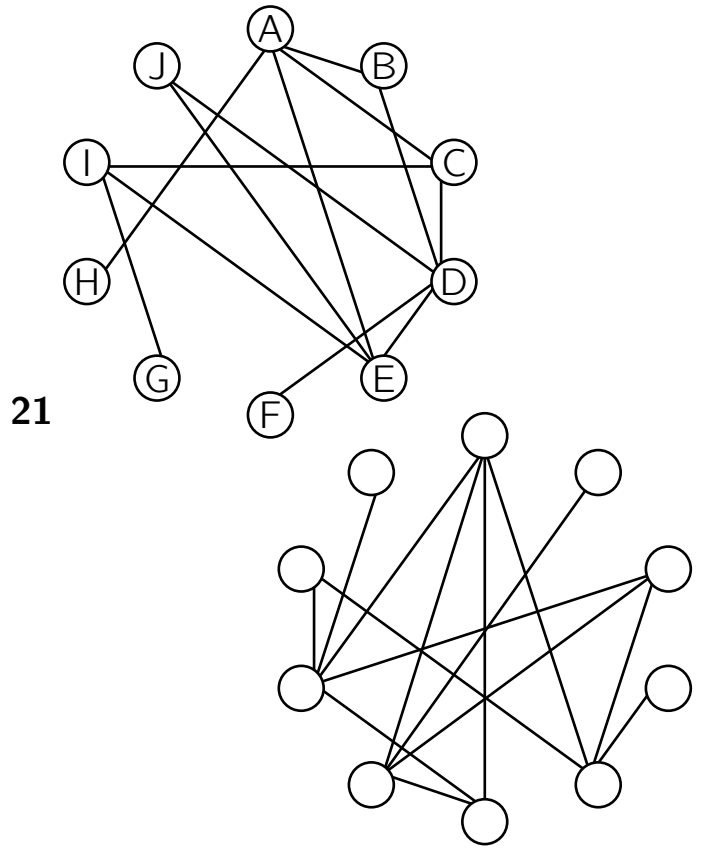

Niveau 3

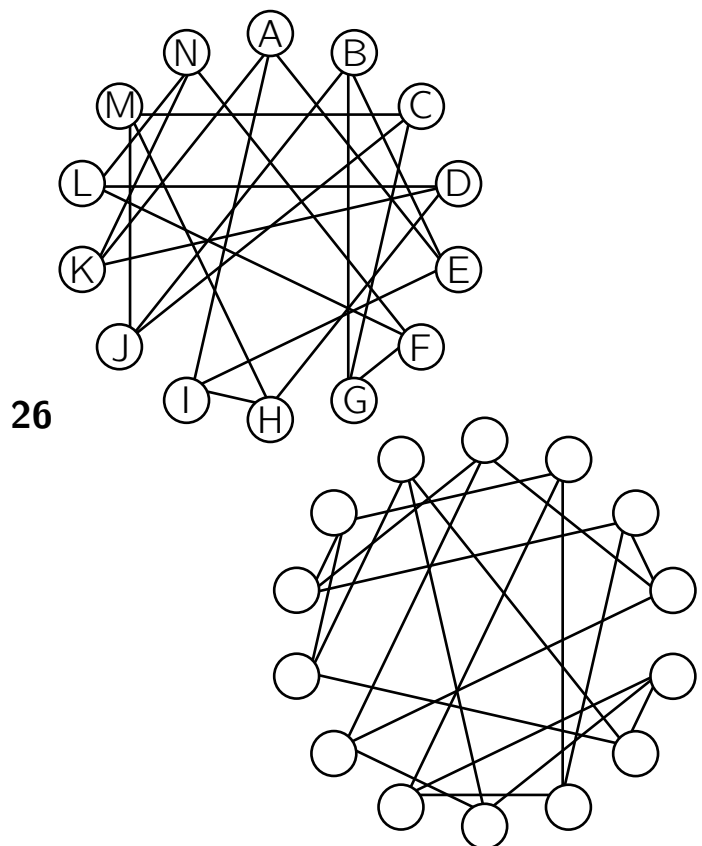
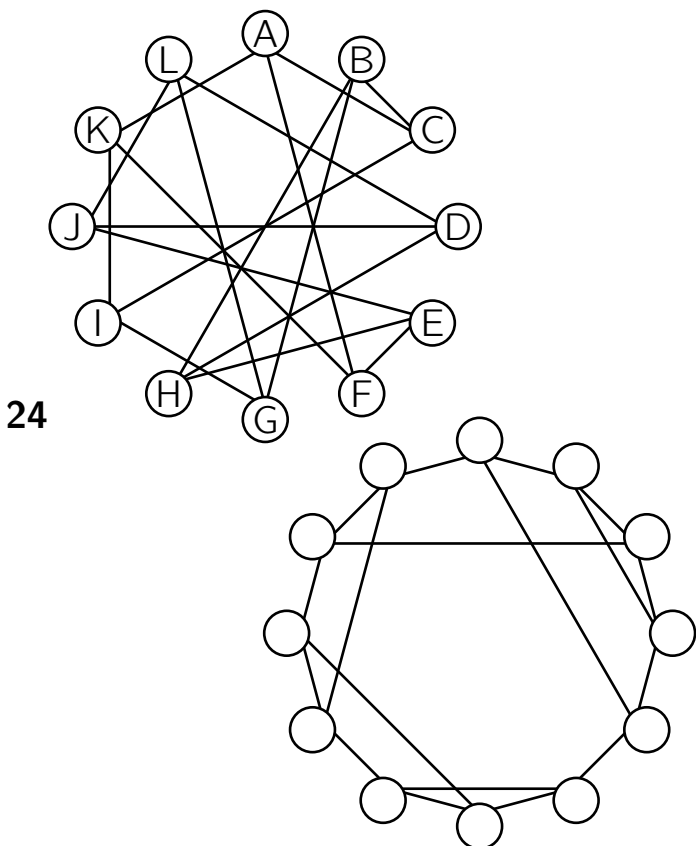
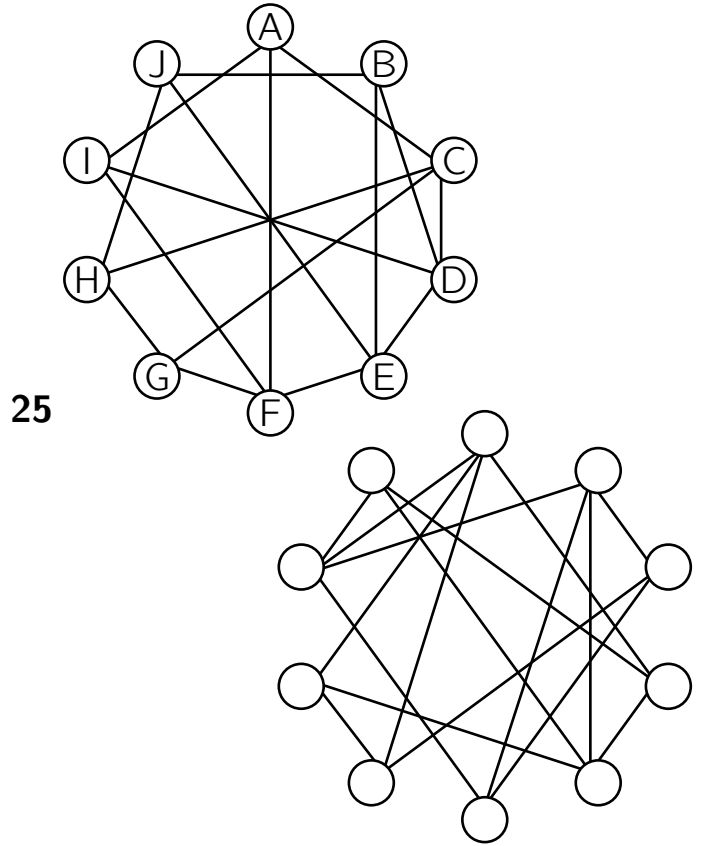
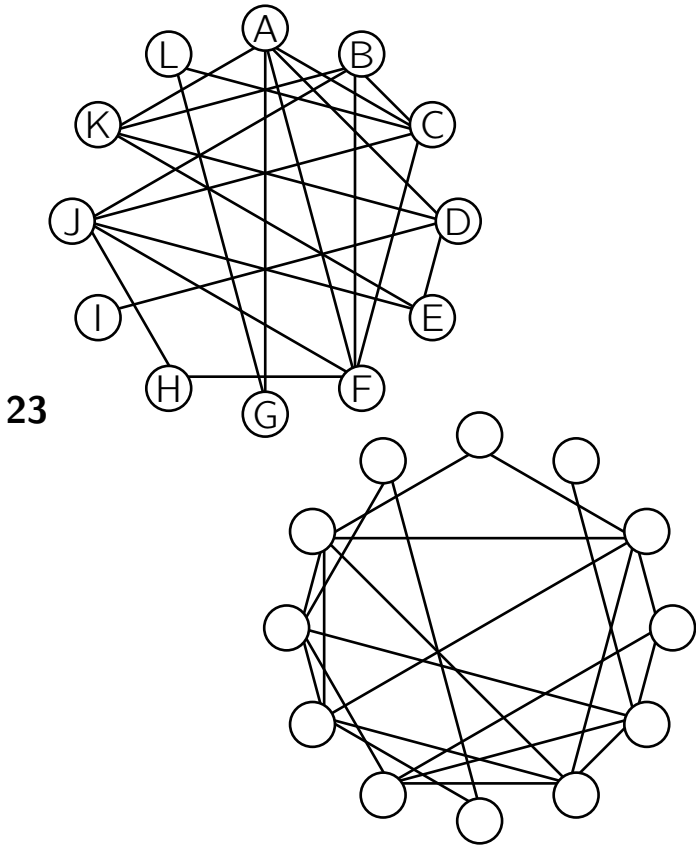

# Nombres en chaîne – Meandering Numbers

## Niveau 1

1

	1		2	1
		5		
	3	1	1	
			3	3
	6		6	
2			4	1

2

6	5		6	
4		3		
				1
		2	1	
	4		6	1
	2		4	2

3

3				2
1				
	5			
		6		
5			2	3

4

1			6	
				3
3	4			
		5		
			4	6

5

				1
			1	

6

3		1		1		1	3
			3				2
5		4		5		4	
			2				2
						5	
	3	2				4	
1			4		6		
2	3	1		3		5	6

7

	3			3		2	
1					4		
			3		3		
	5		5			1	
3				3	4		4
2			1			2	
	3		3	4		4	3
1		1		1	2		

8

2		4				3	
		5		1		2	
2						1	
		5		1	3		4
						1	2
2	1			1		2	1
		3					3
1	2			2		5	1

9

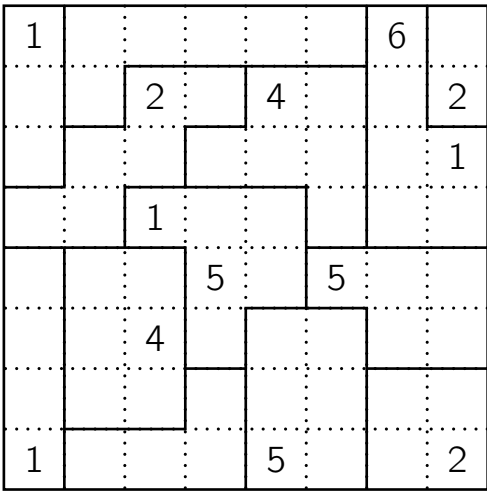

10

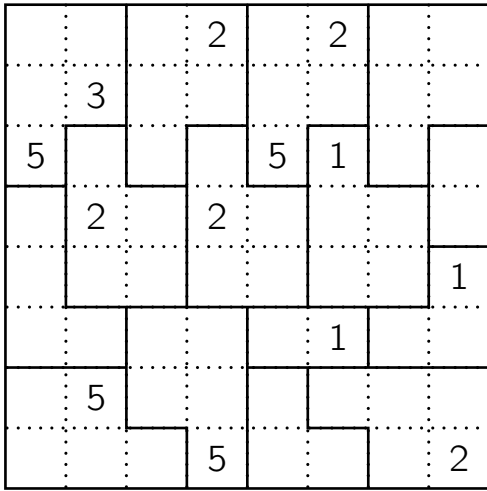

11

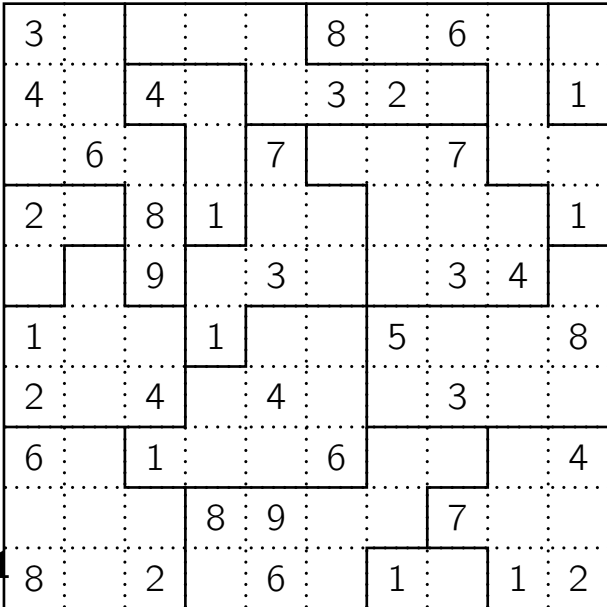

### Niveau 2

12

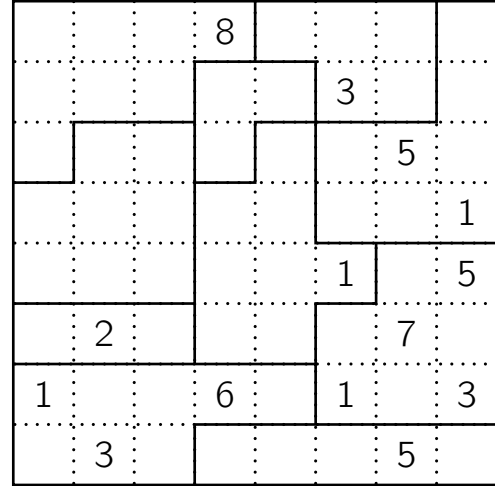

13

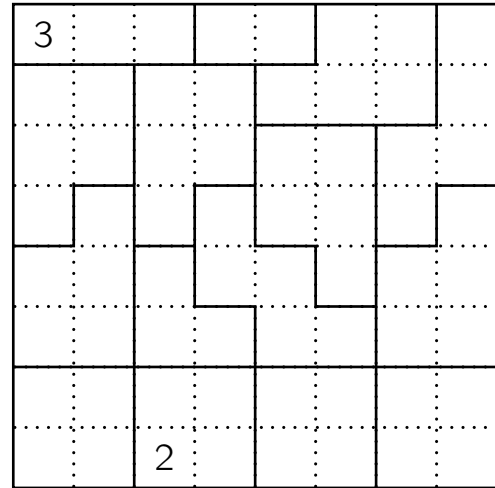

### Niveau 3

14

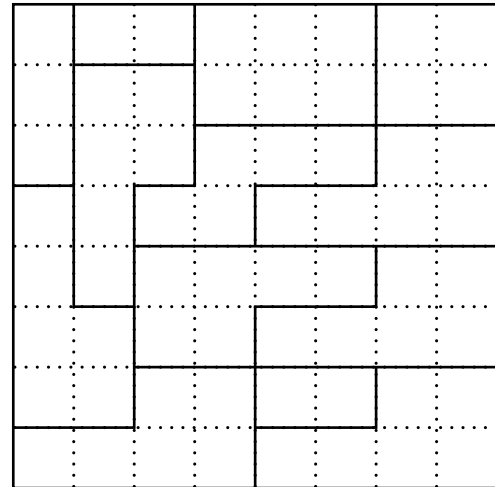

# Nondango

## Niveau 1

1

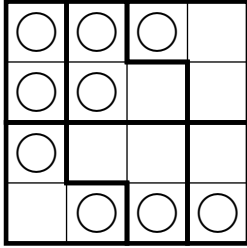

## Niveau 2

2

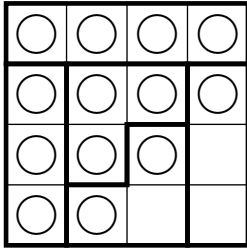

3

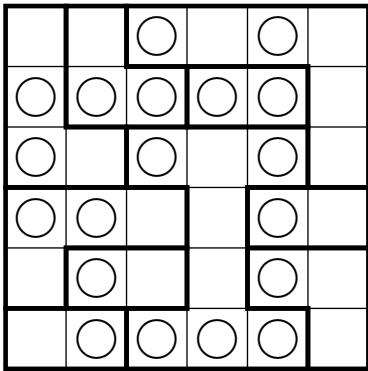

4

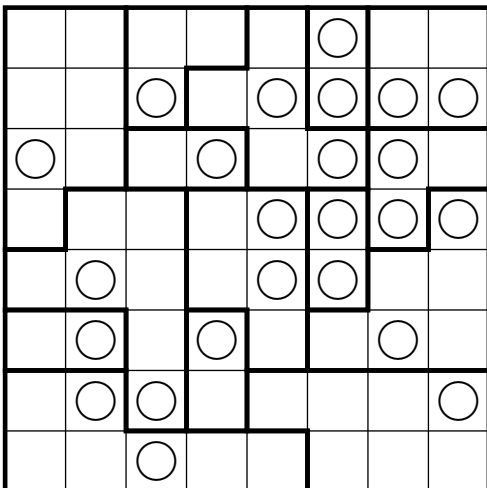

## Niveau 3

5

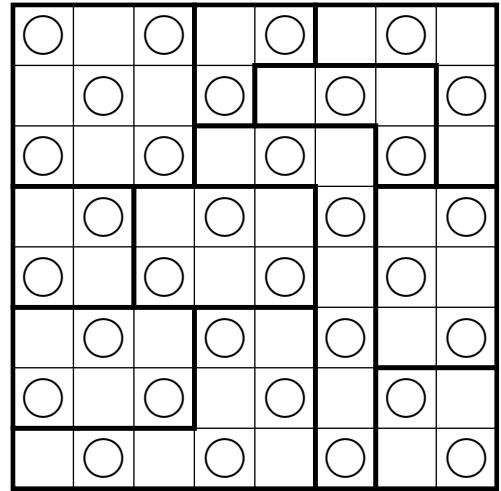

6

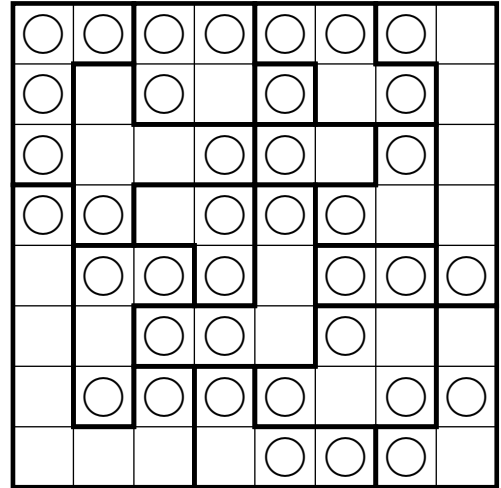

7

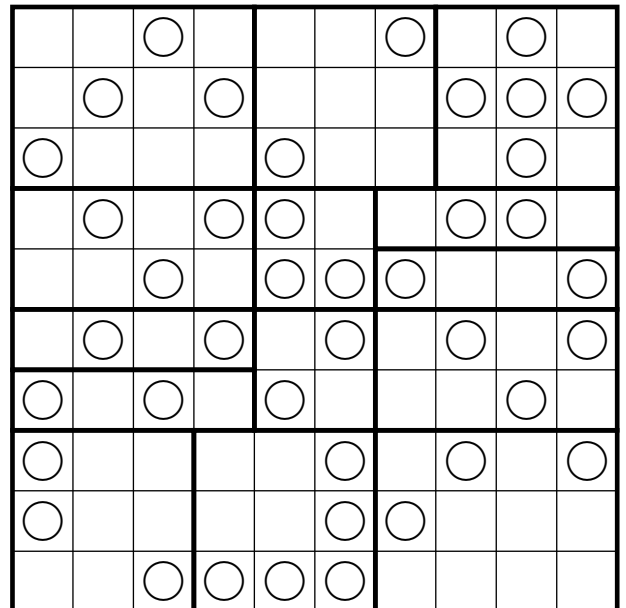



Niveau 4

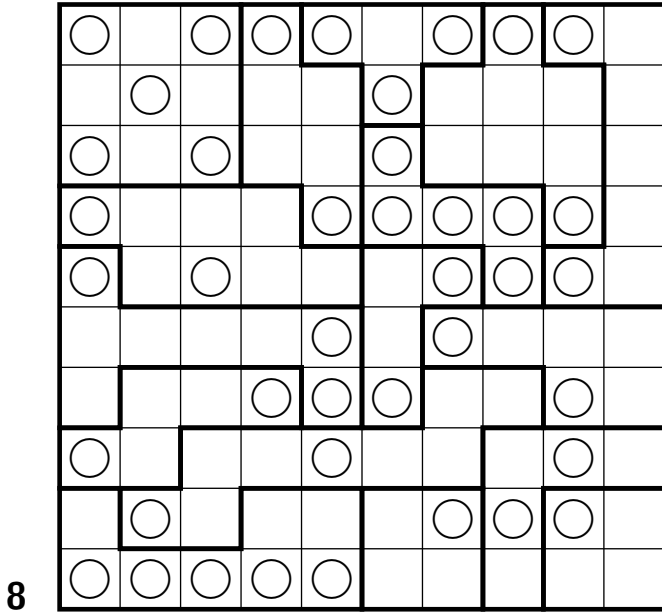

11

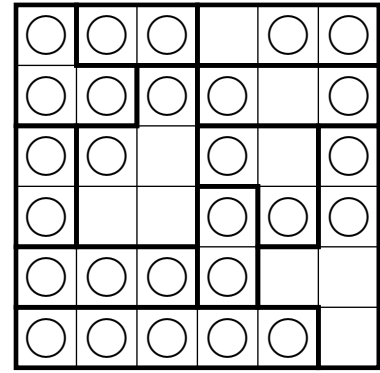

12

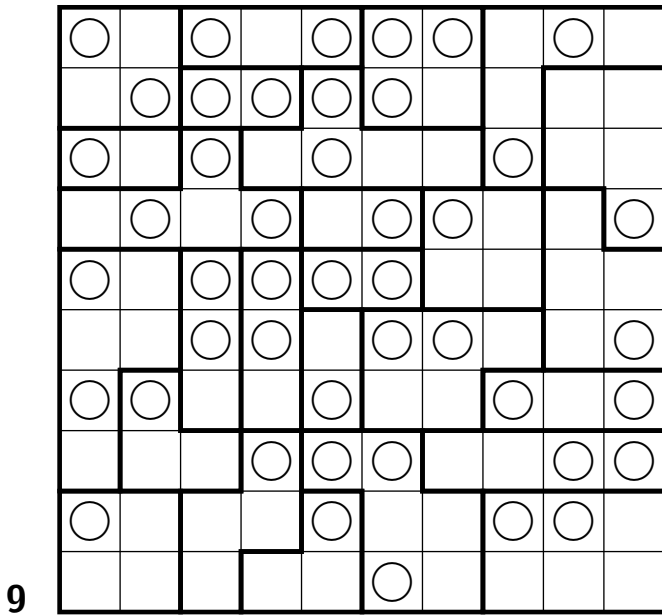
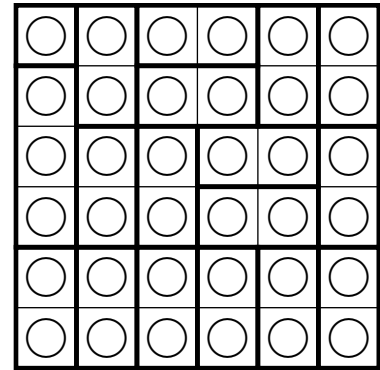

13

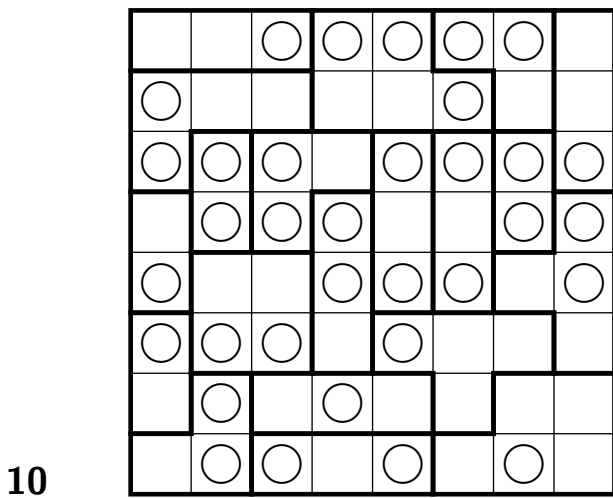
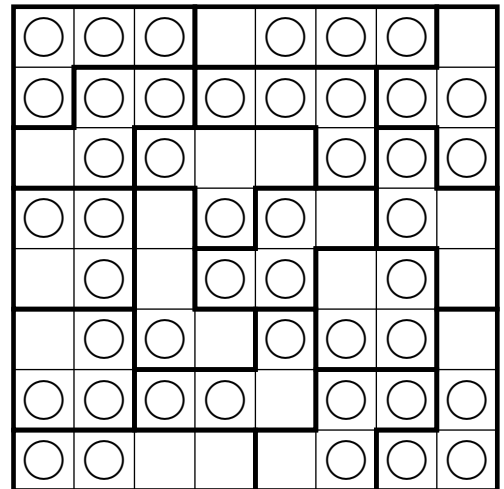

14

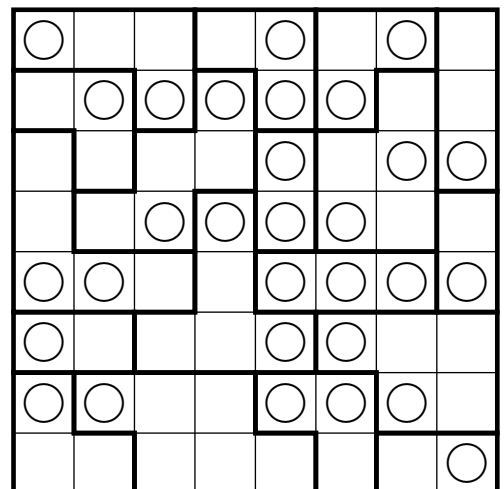

# Number Cross

## Niveau 1

1

	16	7	18	5
18	9	5	6	7
8	5	2	1	1
10	4	8	5	1
14	7	2	7	3

2

	17	13	19	16
15	7	3	1	8
24	7	8	9	2
12	3	8	1	8
14	8	5	9	1

3

	27	17	17	12
19	3	9	6	4
14	9	1	3	2
16	8	2	8	5
19	5	8	8	6

4

	8	22	14	13
10	2	7	7	1
19	7	8	6	5
17	8	7	3	7
11	6	7	5	5

5

	11	15	15	12
14	6	4	3	7
13	4	3	6	5
13	7	3	6	9
13	8	8	8	8

6

	10	25	10	19
17	1	7	9	7
18	8	9	4	9
4	9	8	1	3
25	9	9	7	7

7

	15	16	16	18
16	8	2	8	6
13	4	6	9	3
25	9	8	8	9
11	3	9	8	2

8

	16	11	13	9
10	4	5	7	6
18	5	7	8	3
6	5	6	1	1
15	7	4	4	6

9

	10	9	10	17	13
7	9	3	2	3	5
14	8	9	8	6	7
22	6	2	2	9	5
11	8	7	2	1	3
5	4	1	2	1	8

## Niveau 2

10

	11	13	19	11	9
9	3	6	4	4	6
21	6	7	3	5	4
5	2	9	6	3	1
15	2	5	9	2	6
13	2	9	7	3	3

17 22 13 27 13

32

7	8	2	9	8
8	5	2	4	5
2	9	4	9	1
6	2	1	7	3
2	5	8	7	1

11

16 12 20 24 13

20

7	5	8	9	8
4	2	5	6	1
8	1	3	7	7
4	4	2	9	8
5	1	5	8	6

16

19 6 23 16 15

8

9	3	6	6	2
2	2	3	9	9
8	8	4	7	4
2	3	6	9	1
9	3	8	8	9

12

9 18 17 14 21

16

8	9	7	8	6
5	7	6	4	7
6	6	7	6	3
7	9	6	8	6
4	3	3	5	5

17

4 11 10 19 14

10

2	4	1	3	7
9	7	1	1	9
1	2	2	8	8
1	9	2	6	6
2	5	6	9	8

13

17 20 27 18 23

10

8	7	5	8	2
8	8	7	9	7
6	1	7	1	8
3	7	8	1	6
2	4	5	9	2

18

19 12 9 15 20

24

9	3	4	6	5
9	7	8	5	6
1	6	5	3	3
3	5	1	7	6
8	7	9	2	7

14

9 17 22 28 12

18

6	4	4	4	4
7	5	4	9	4
1	7	9	6	3
9	4	9	6	7
3	8	7	7	1

19

16 10 10 12 29

21

5	8	9	2	8
5	7	2	3	5
5	1	8	3	8
1	1	8	2	6
2	1	6	7	7

15

19 13 5 18 16

13

5	4	7	9	4
6	7	7	5	2
5	5	2	9	7
5	9	4	4	4
8	9	3	6	7

20

# Patchwork — Tatami

## Niveau 1

1

		2		1	2		
		1	2	4		1	2
1	4						
			2				
3	2				2		
	1		4				
			2	4			
1							

2

		4			3		
		2	4	3			
					3		
1					3		
	1			1			2
					4		1
2	4				2	4	
		3	4		1		4

3

					2		3	
				1			1	
							2	
							1	
2	1	3			1			3
								1
				1				
					1			
			3	2	1	3		

4

		3						3
2			2	3			3	
			3					
2	1		1		3			1
			2					
	1	2						2
					1			
								2

## Niveau 2

5

							2	
						1		
	1		1					
	1							
					1	2		1
							2	
					2			2

6

					2			2
		3				1		
2								
		3						
2								

7

		4			3	
		2	4	3		
					3	
1				3		
	1			1		2
					4	1
2	4				2	4
		3	4		1	4

10

			4			2	
		4					4
	1				2		1
1			3			4	
	4						
3	2		3		2		

Niveau 4

8

			2		2	1	
		2	4			4	
4	3		1				
							2
	3						1
1	2		3				
			2		4		
							3

11

	3				1		
		4		1			
4			3			1	
			4				3
		1				1	
							1

Niveau 3

9

				1			3
3				3			
			3				
	2						
				1			

12

			1				
		2					
						2	
			1				
	1						

# Perles — Masyu

## Niveau 1

1

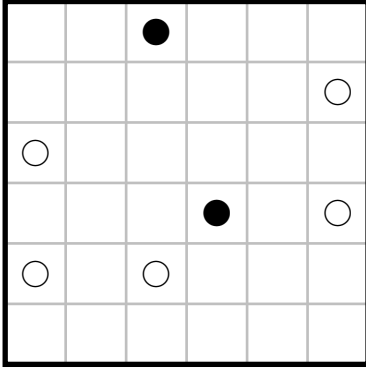

2

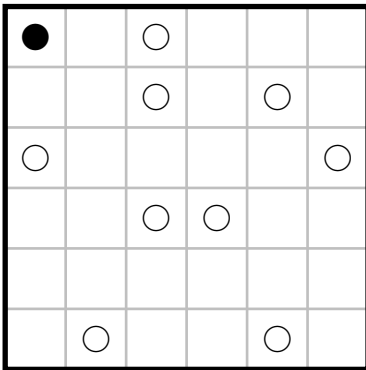

3

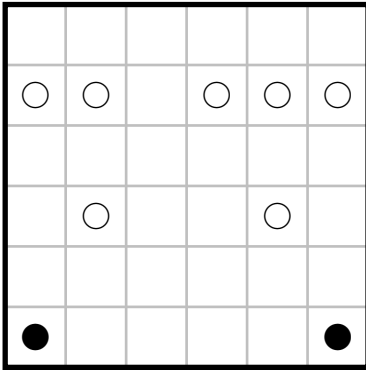

4

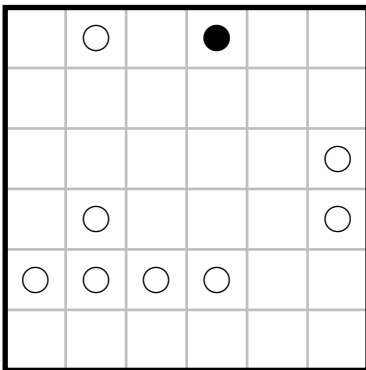

5

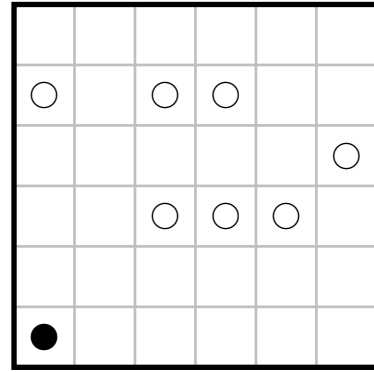

6

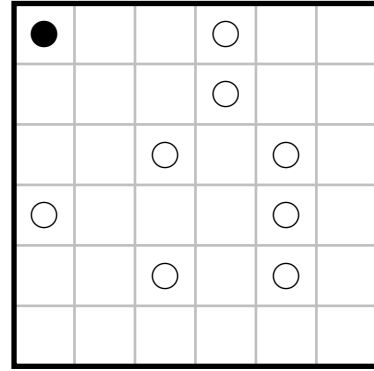

7

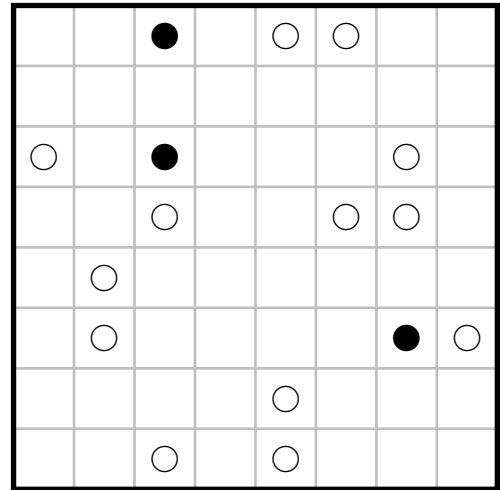

8

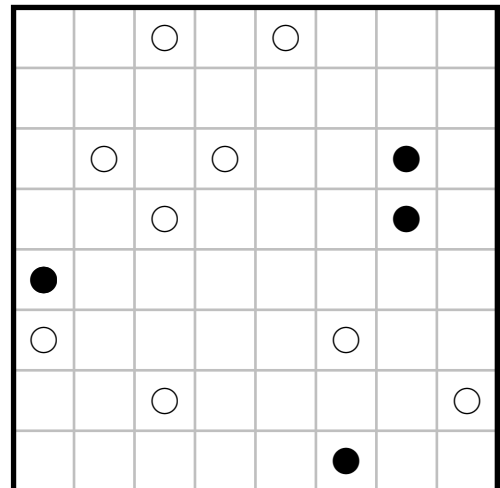

9

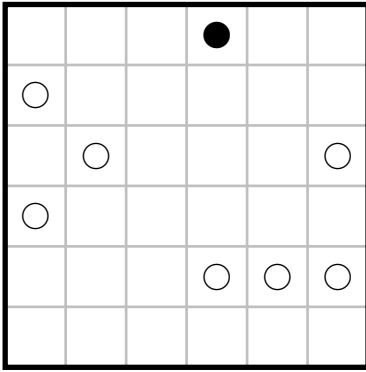

13

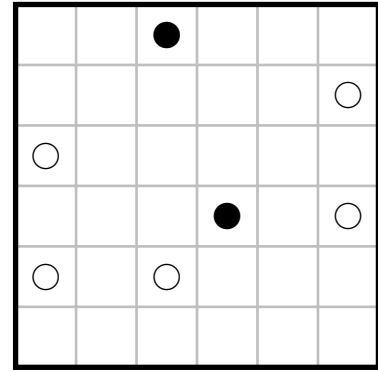

Niveau 2

Niveau 3

10

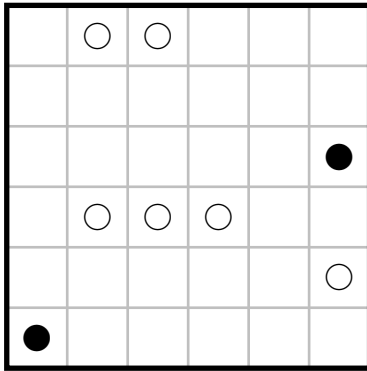

14

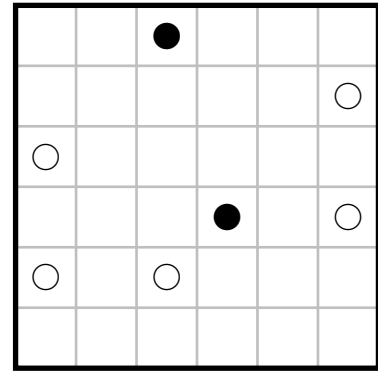

11

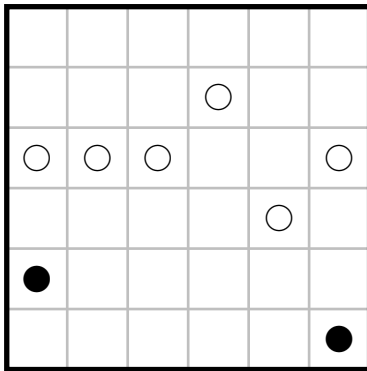

15

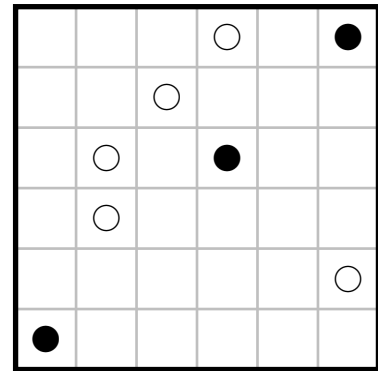

12

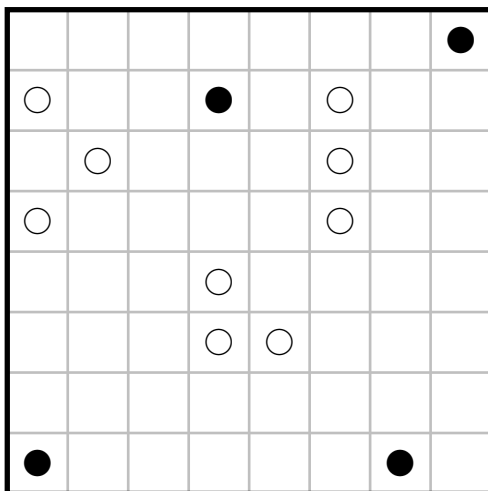

16

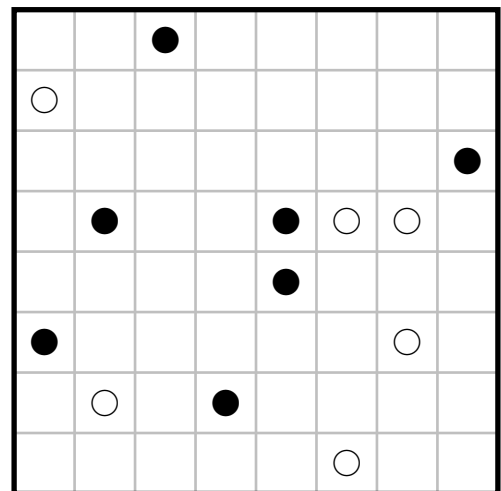

# Phares

## Niveau 1

1

		3					
						1	
					1		
							1
	0						
			2				

2

			2				
	0				1		
	1						
						1	

3

				1			
	1						
						1	
				2			
	1						
							3

4

	4						
							2
	1						
							1
		0			1		

5

				0			
						3	
1							
					1		
		4					
							2

6

							0
				1			
						3	
					2		
3							2

7

	1						
				3			
1				3			
						0	
	2						

8

				1		2	
2							
				1			
	2						0



## Niveau 2

9

				3			1
						2	
		3	3				
						1	
		4				1	
7							

10

						2		2
1							1	
		4						
							2	
					2			
3			4					

11

3		1						
				5				
								3
3								
		1						
	1				1			
								1

12

					4	3	
		2					
					1		
1							
			4				
						2	
2							
							4

13

	3	5					
				3			
3							
				2		3	
				2			
	1						

14

						4	2
						4	
							2
4							1
		4					
					2		
		4					

# Pipelink

## Niveau 1

1

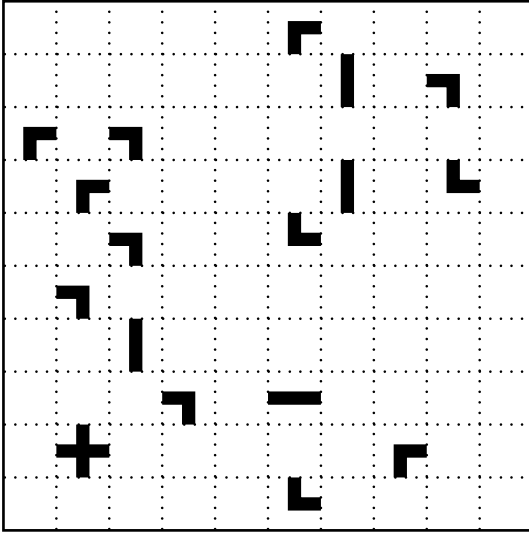

2

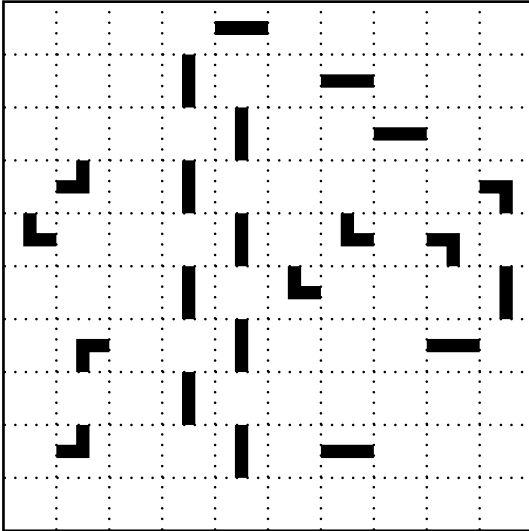

3

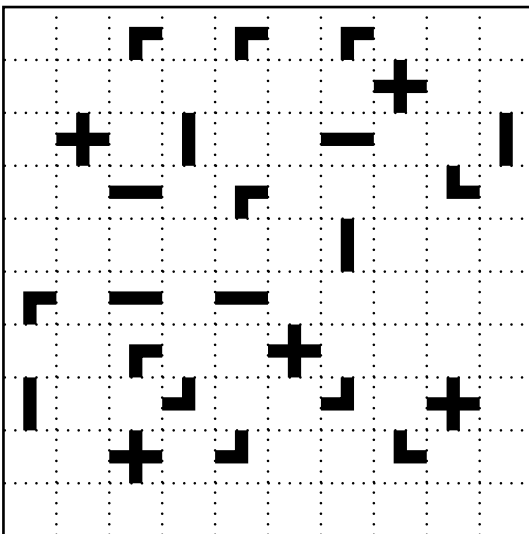

4

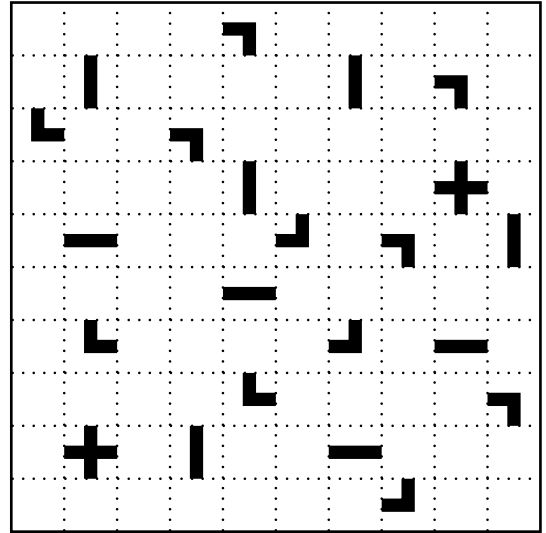

5

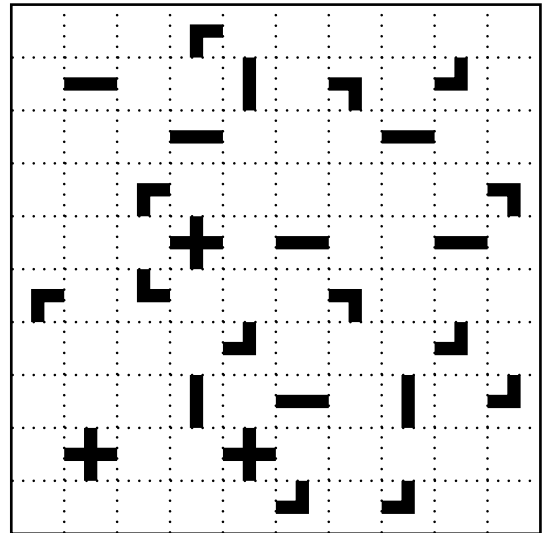

6

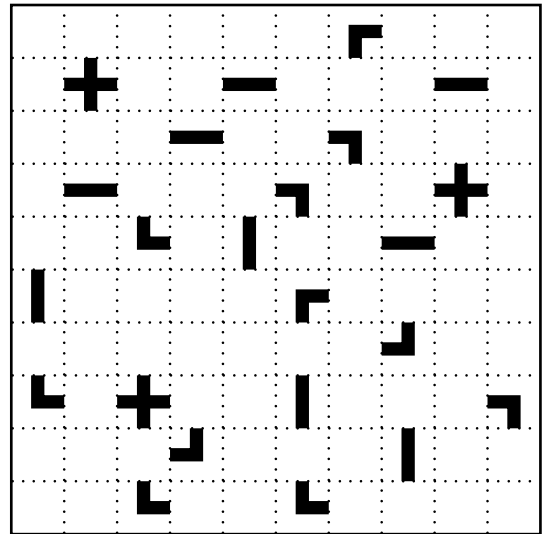



# Ponts

## Niveau 1

1

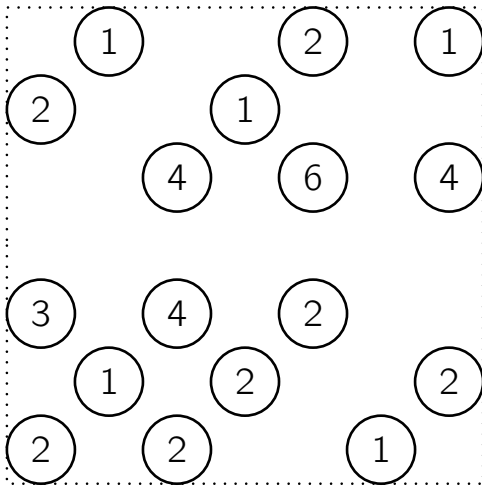

2

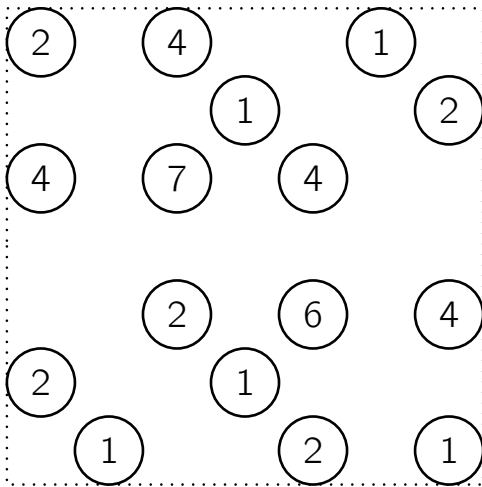

3

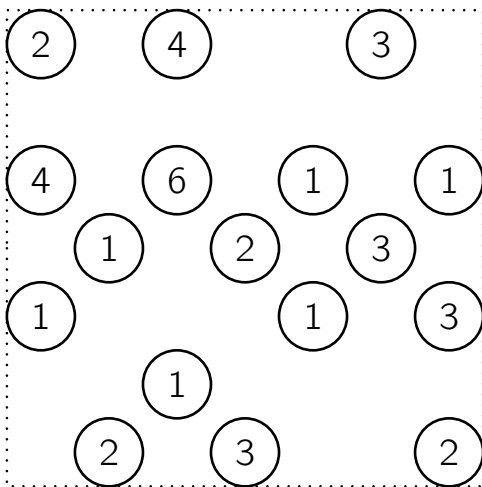

4

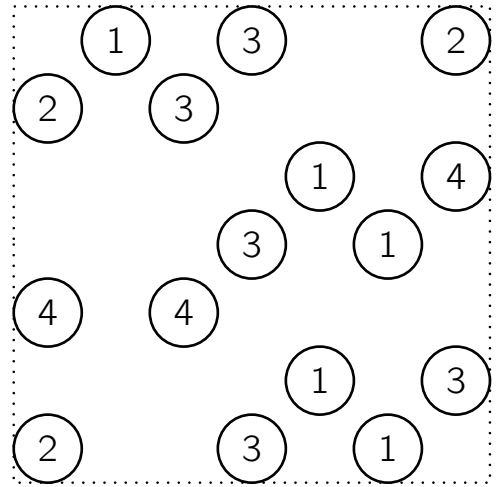

5

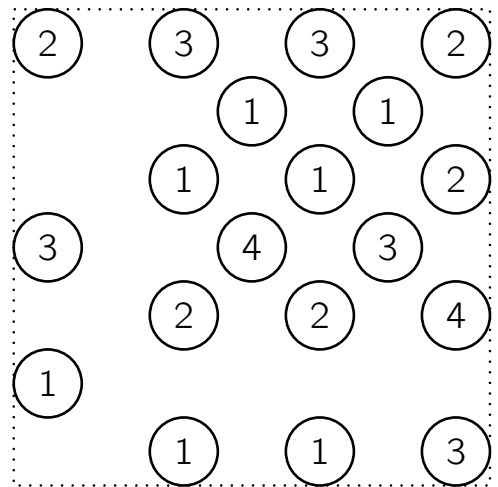

6

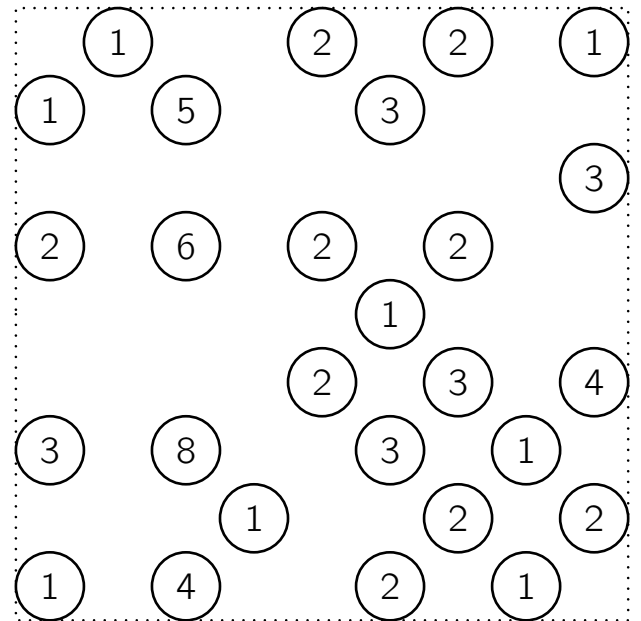

## Niveau 2

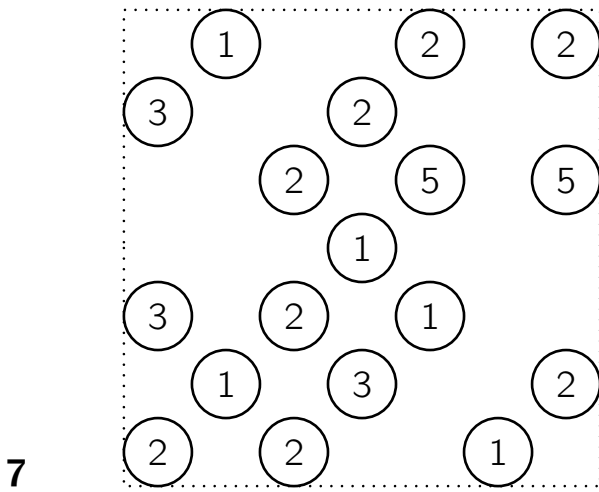

10

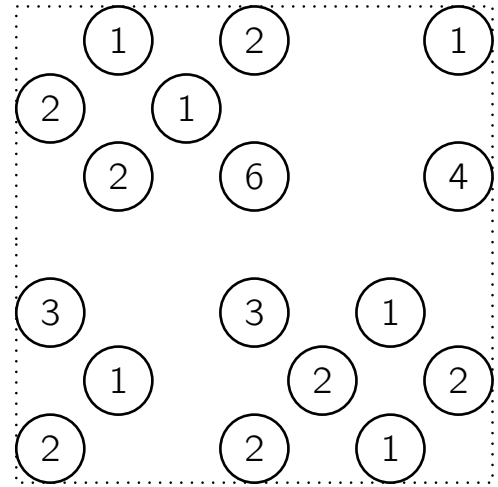

## Niveau 4

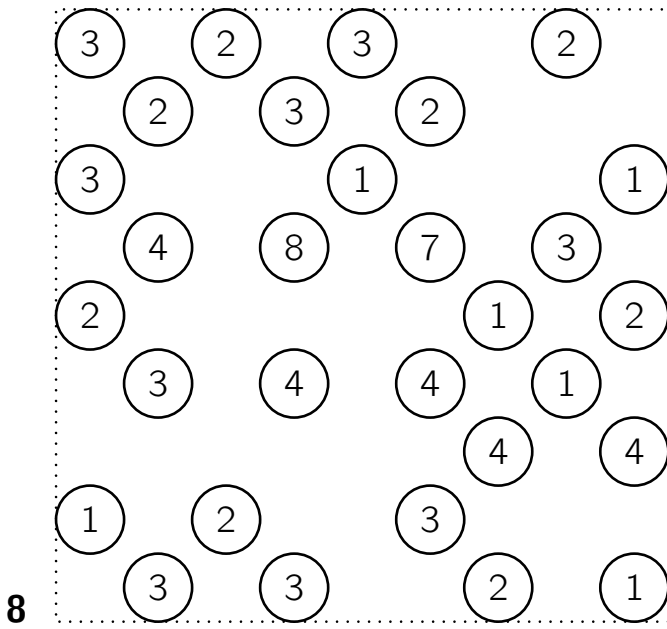

11

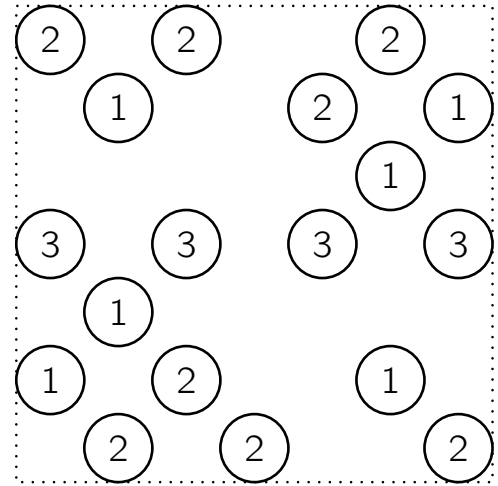

## Niveau 3

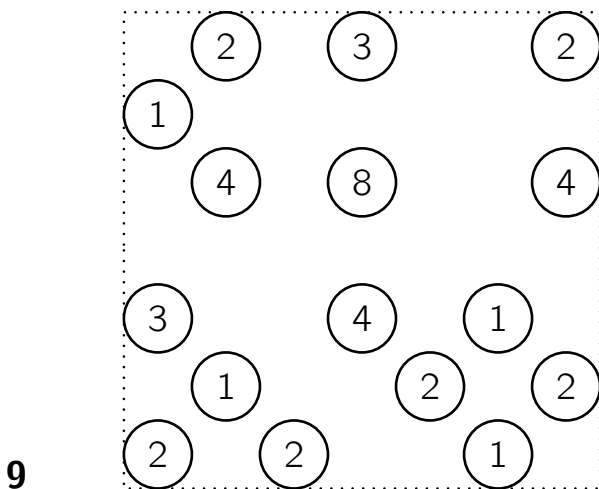

12

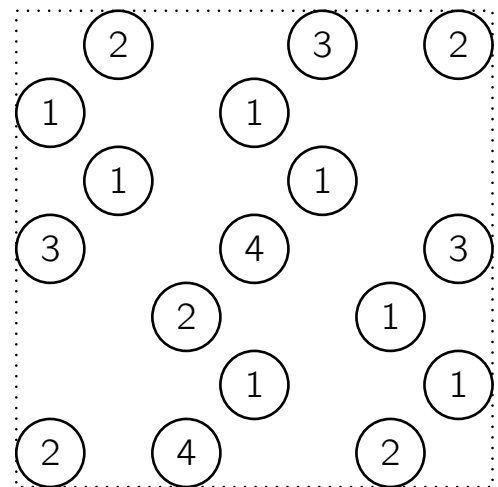

# Portes — Seethrough

## Niveau 1

1

5	4		5		
+	+	+	+	+	
2		4	+	+	3
	4	6	3	+	
+	+	5	+	+	4
+	+		+	+	
	4		6		4

2

5		5	4	4	
+	+	+	+	+	
4	3		4		
+	+	+	+	+	
4		2		4	
+	+	+	+	+	
	2		2	4	
+	+	+	+	+	
4	4	3			3

3

4		4	6	5	
+	+	+	+	+	
	3				2
+	+	+	+	+	
4		6			2
+	+	+	+	+	
2			3		
+	+	+	+	+	
2	3	4			2

4

	4	4		4	
+	+	+	+	+	
2	2		3		
+	+	+	+	+	
4				5	
+	+	+	+	+	
	4		4	5	
+	+	5	+	+	
5		5	6		

5

3	3	5		1	3
+	+	+	+	+	
2			3		4
+	+	+	+	+	
	3	5	4		5
+	+	+	+	+	
5		4	2	4	
+	+	+	+	+	
5		4			4
+	+	+	+	+	
4	2		4	4	5

6

2	1	2	2	1	2
+	+	+	+	+	+
1	2	2	2	2	1
+	+	+	+	+	+
2	2	2	2	2	2
+	+	+	+	+	+
2	2	2	2	2	2
+	+	+	+	+	+
1	2	2	2	2	1
+	+	+	+	+	+
2	1	2	2	1	2

7

3	6	4	5	4	3
+	+	+	+	+	+
2	5	3	4	3	2
+	+	+	+	+	+
5	6	4	5	4	3
+	+	+	+	+	+
3	8	6	7	5	5
+	+	+	+	+	+
4	5	3	2	2	2
+	+	+	+	+	+
5	2	4	3	2	3

## Niveau 2

8

5	4		4	5	
+	+	+	+	+	
4		3		4	3
+	+	+	+	+	
	5	4	5		5
+	+	+	+	+	
6		4	5	4	
+	+	+	+	+	
5	2		4		4
+	+	+	+	+	
	4	4		3	4

9

	3		3	3	5
+	+	+	+	+	
4	2	4		4	
+	+	+	+	+	
	4	6	4		3
+	+	+	+	+	
5		4	3	4	
+	+	+	+	+	
3	4		4	5	3
+	+	+	+	+	
4		3		4	

10

5	3	3	4	5	3
+	+	+	+	+	+
6	4	4	5	4	2
+	+	+	+	+	+
3	4	4	4	5	5
+	+	+	+	+	+
4	4	6	5	6	6
+	+	+	+	+	+
3	5	5	4	3	5
+	+	+	+	+	+
2	4	4	3	2	4

15

4		5			5
+	+	5	+	+	+
	5		2	4	
+	+	+	+	+	+
4		2	3	3	
+	+	+	+	+	+
	3	4	2		5
+	+	+	+	+	+
4	2	5		5	
+	+	+	+	+	+
3	5		4		4

11

	7		3		4
+	+	+	+	+	+
6		4	2	2	
+	+	+	+	+	+
	5		4	2	3
+	+	+	+	+	+
6	6	4		4	
+	+	+	+	+	+
	4	5	4		4
+	+	+	+	+	+
6		4		4	

16

6		3			
+	+	+	+	+	+
	3	6	4		5
+	+	+	+	+	+
5	3			5	
+	+	+	+	+	+
	7			5	4
+	+	+	+	+	+
7		6	6	3	
+	+	+	+	+	+
		3			5

12

4	4		4	5	3
+	+	+	+	+	+
4		4		5	
+	+	+	+	+	+
	4	4	4		4
+	+	+	+	+	+
2		2		5	
+	+	+	+	+	+
3	4		4	3	5
+	+	+	+	+	+
4		5		5	

17

3	1		1		1
+	+	+	+	+	+
	5	3		5	
+	+	+	+	+	+
4		5	6	6	
+	+	+	+	+	+
	5	6	7		5
+	+	+	+	+	+
	3		5	5	
+	+	+	+	+	+
3		3		6	6

Niveau 3

13

	4	8		3	
+	+	+	+	+	+
4		5	5		3
+	+	+	+	+	+
3	3		6	5	
+	+	+	+	+	+
	4	6		4	5
+	+	+	+	+	+
3		7	2		4
+	+	+	+	+	+
	4		3	5	

18

4	3		4		3
+	+	+	+	+	+
3		3		4	
+	+	+	+	+	+
3	4		3		
+	+	+	+	+	+
	3	4		4	
+	+	+	+	+	+
4	3			4	
+	+	+	+	+	+
	4	3	3		4

14

	7	7		6	
+	+	+	+	+	+
5	3			3	3
+	+	+	+	+	+
		4	4		5
+	+	+	+	+	+
6		4	5		
+	+	+	+	+	+
5	5			5	3
+	+	+	+	+	+
	3		5	3	

# Rectangles — Sikaku

1

3	2	2	3
		2	
	2		
2	2		2
		3	2

2

	2		2
2	4		
	4		
2	2		2 3
	2		

3

4			
2		2	
4			
	4		4
	3		2

4

3			4
		2	
			4
	2	2	2
2		4	

5

		3	
2		2	
2	3		3 2
	2		
2			2 2

6

		3		
		4	2	2
2			2	
2			2	2
2			3	6
				4

7

2			3	2	2
		3			
2				6	2
2					
2	2		2		2
	2				2

8

	2	2		2	
		2		2	
	2			2	
3					
	4		3	2	4

9

3	2				4
			2		
	4		4	2	
				3	5
		2	2		
3					

10

4	5			3
		3		
			6	
				4
			2	2
2		5		



11

	2			2	
	2		4	2	
		4		2	2
	2	2			4
	2	3			
2	2			4	3
			3	2	

12

	3			2	2
				2	
		2		2	4
6	4		4	3	6
	2	2			
			3		2

13

			6		
					5
4	3	2	4		3
					8
3		6		3	
			2		

14

					2
			6	2	2
	2		4		
6		3			
	3				4
			4		2
				2	2
	2			3	

15

					7
2				5	2
	2				7
		2			6
3		4			8
	4				
	2			5	2
			5		3
6					2

16

					8
	6			6	
5				5	
				5	5
					7
2		2			5
	3		3		3
2			4		4
		2			2

17

2					
2		6		3	2
			2		2
			2	2	
5		6		2	3
	7		3		
					6
				9	
	3			4	
					2

# Roma

## Niveau 1

1

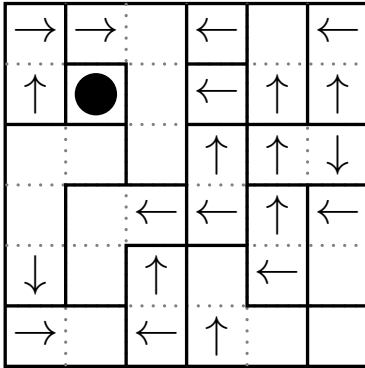

2

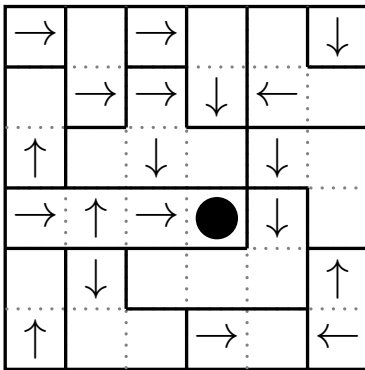

3

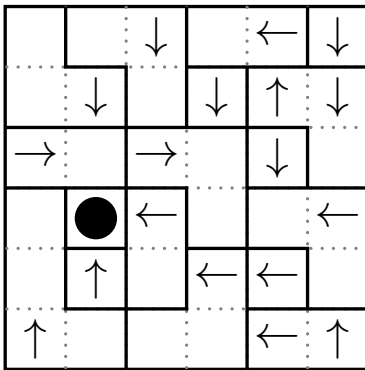

4

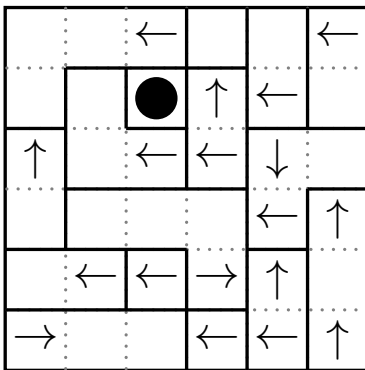

5

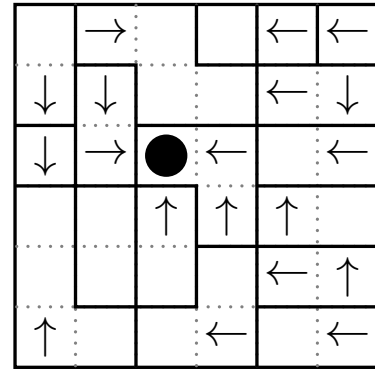

6

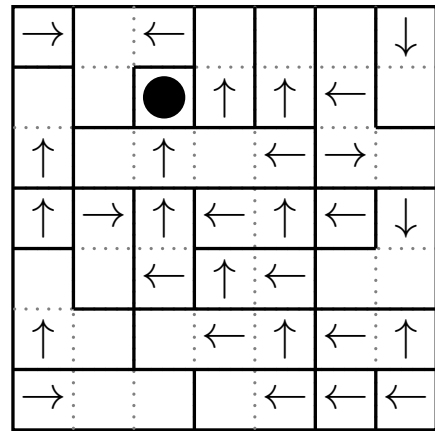

7

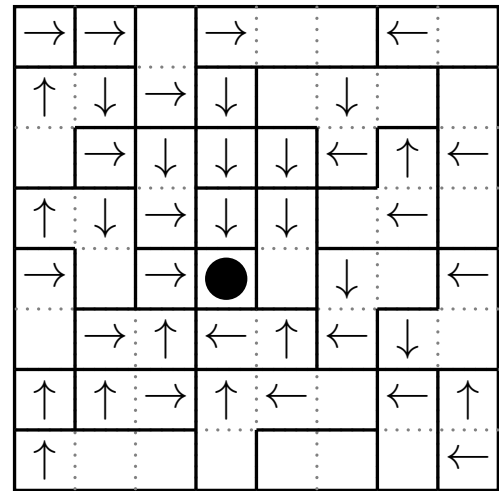

8

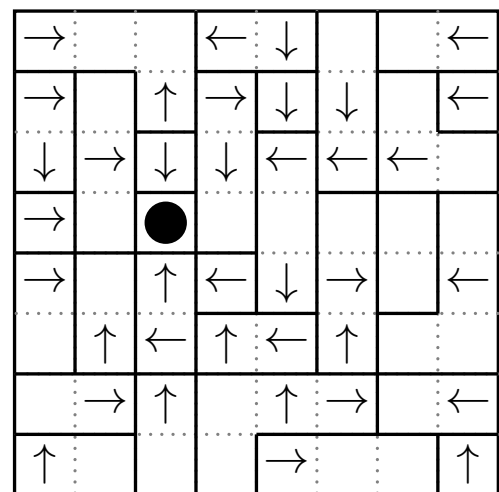

## Niveau 2

9

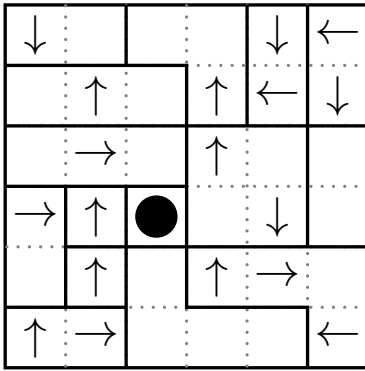

13

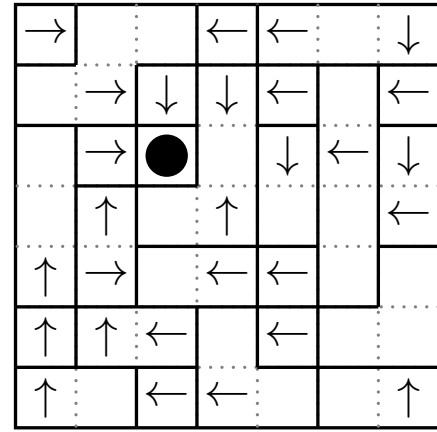

10

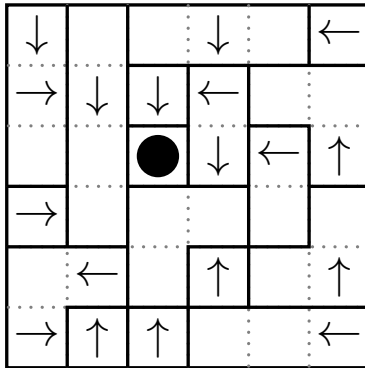

## Niveau 3

14

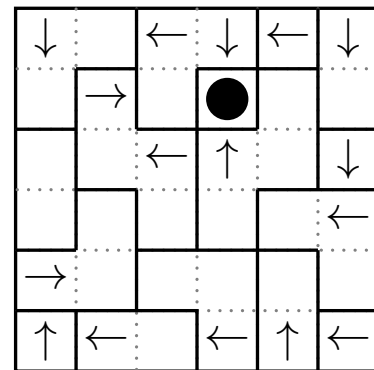

11

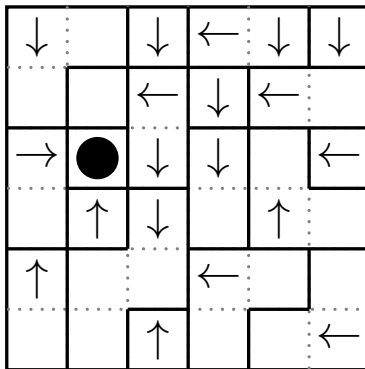

15

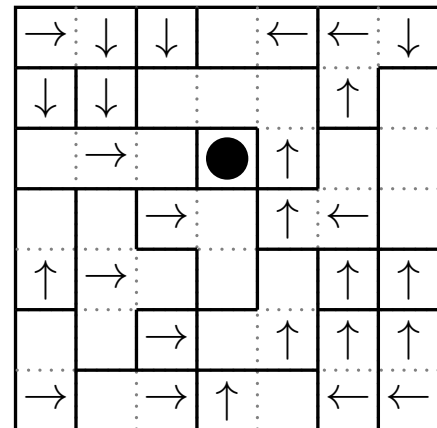

12

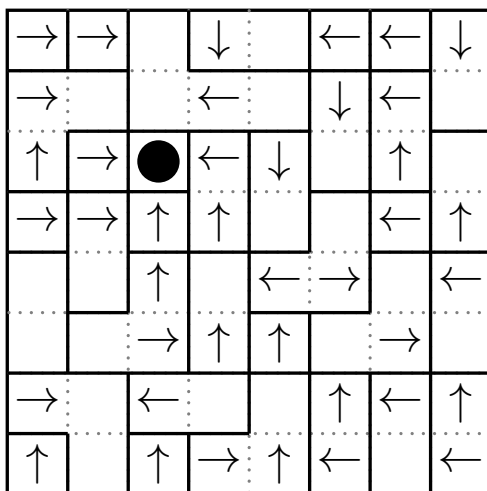

16

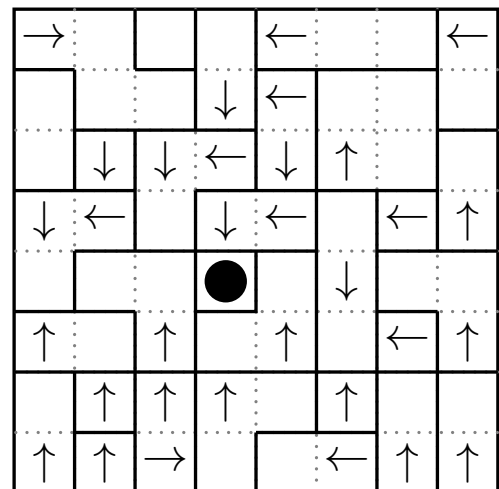

# Ruisseau — Kuriku

## Niveau 1

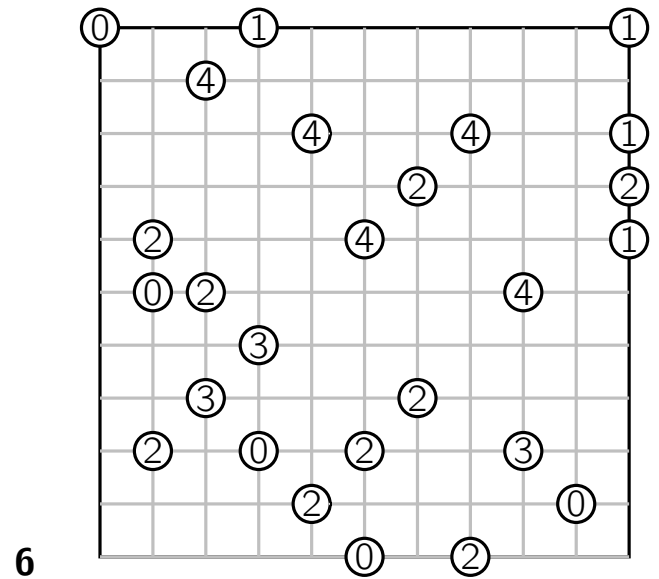
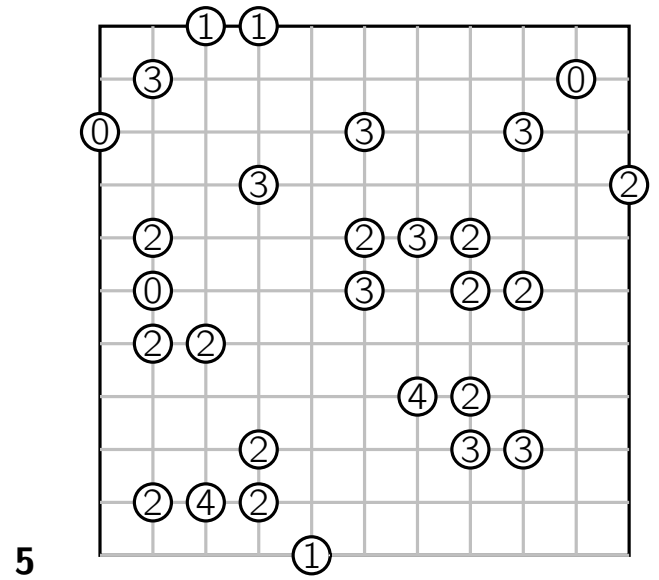
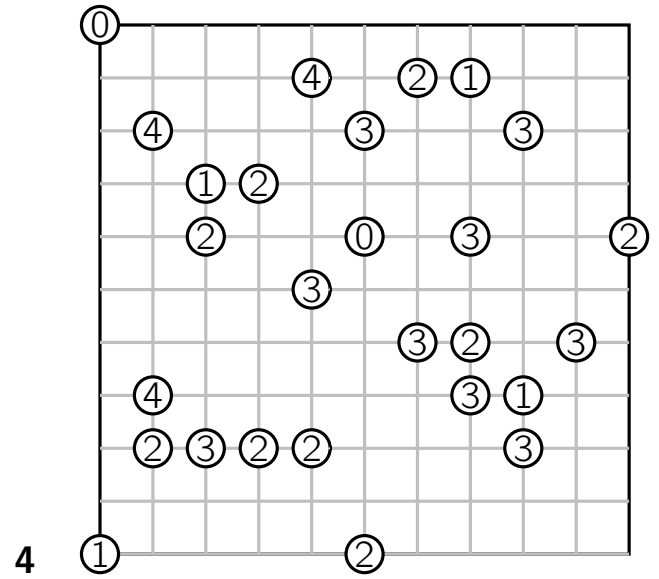
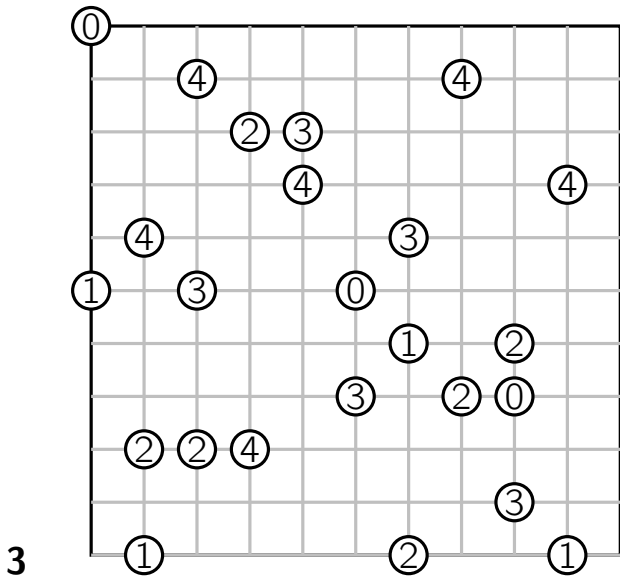
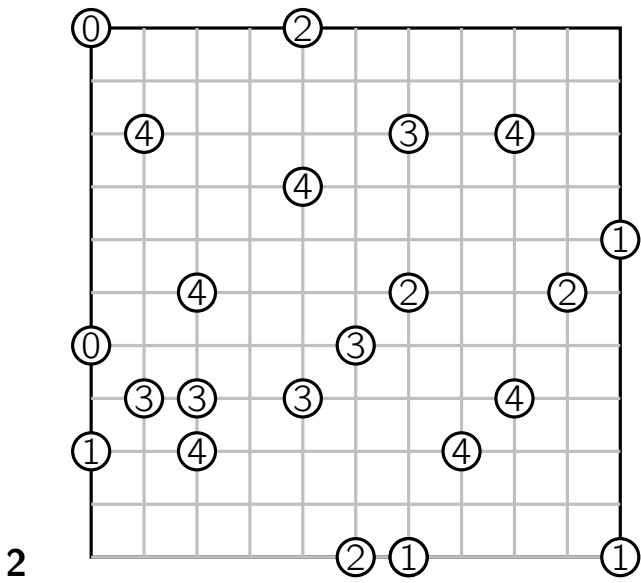
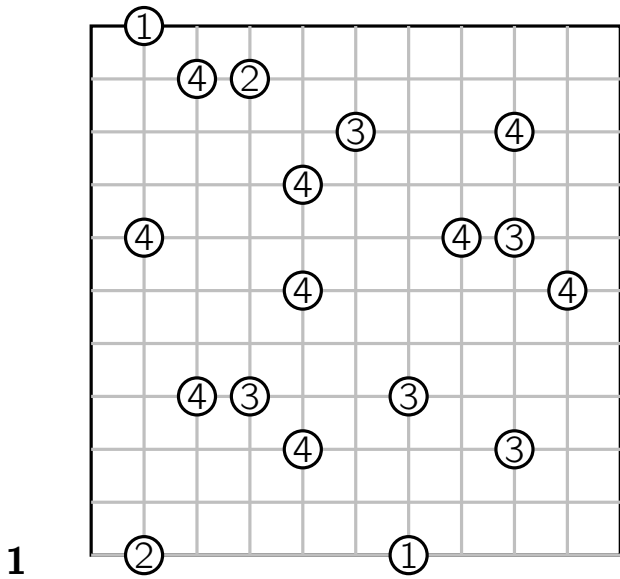

## Niveau 2

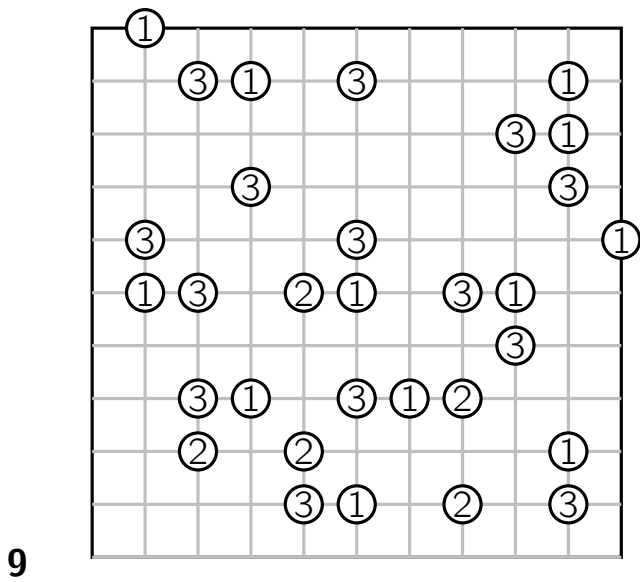
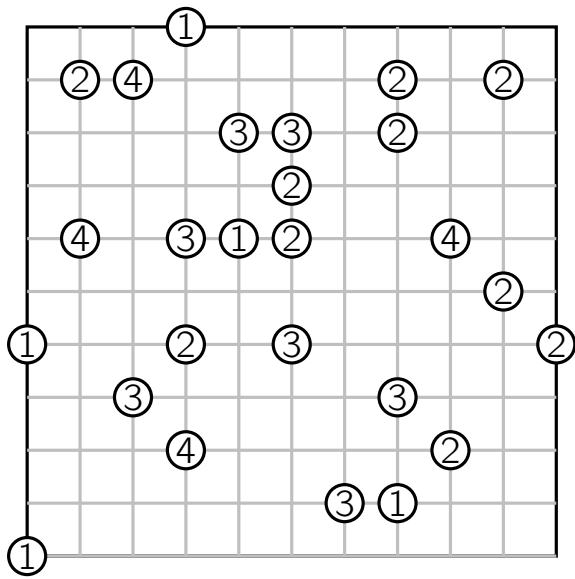
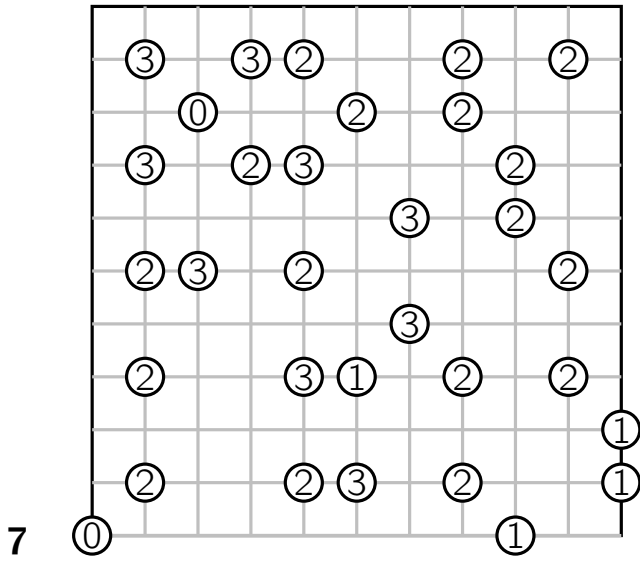

## Niveau 3

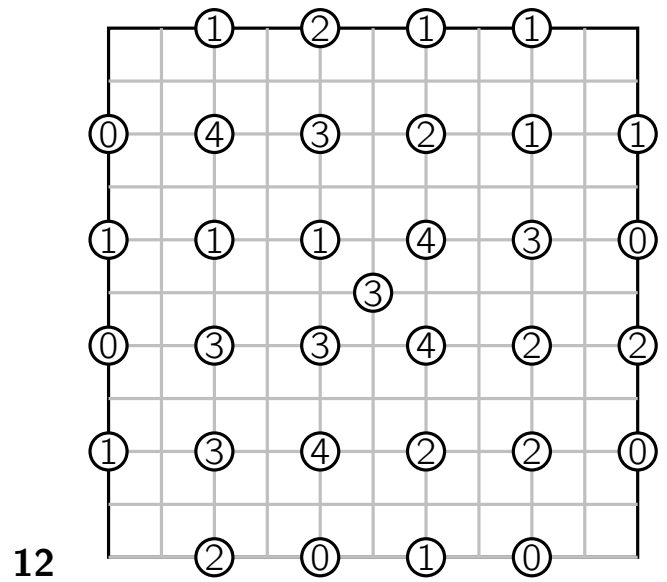
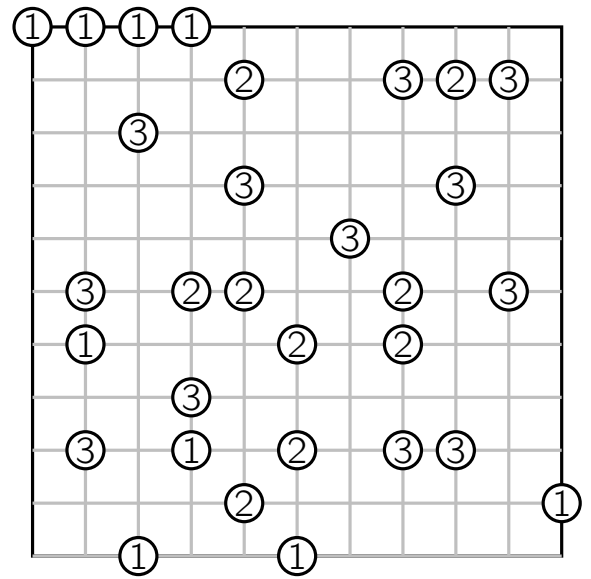
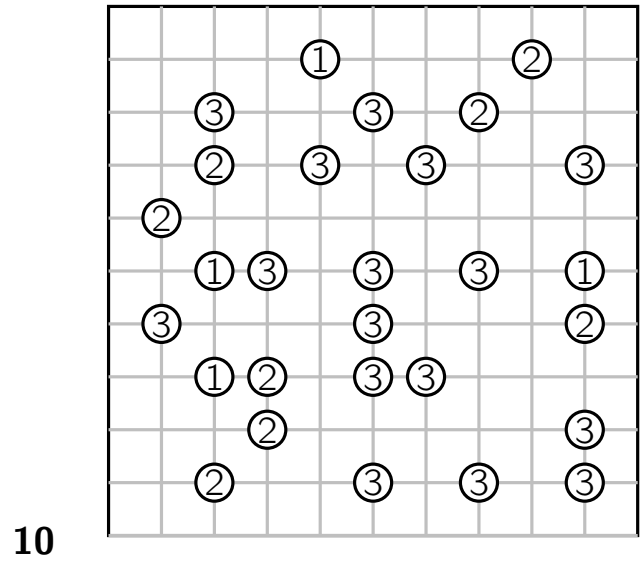

# Salto

1

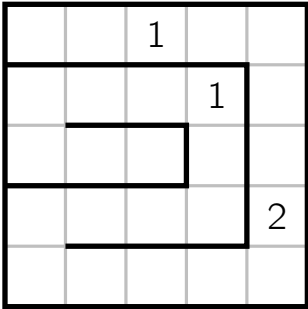

2

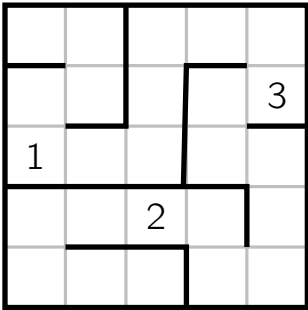

3

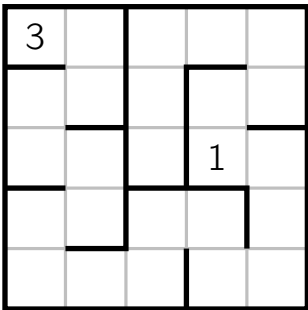

4

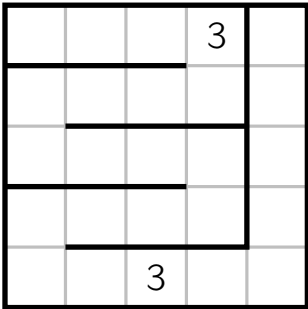

5

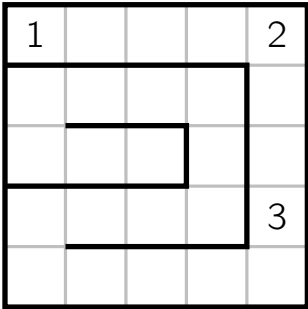

6

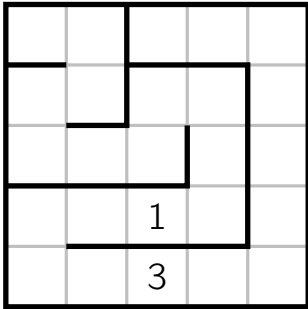

7

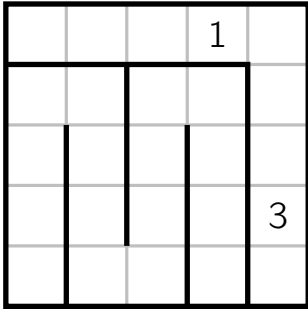

8

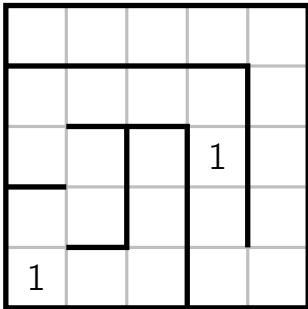

9

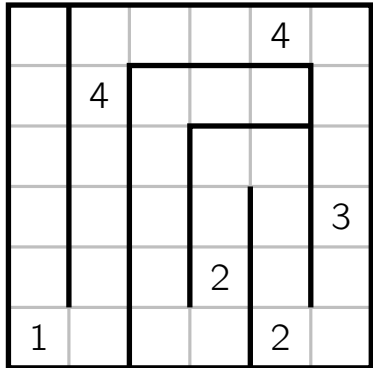

10

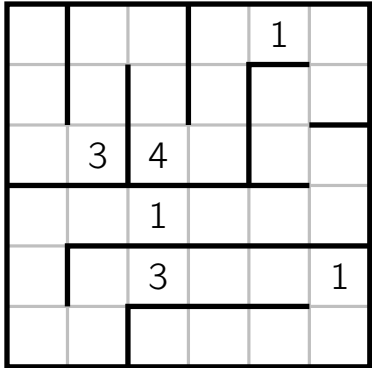

11

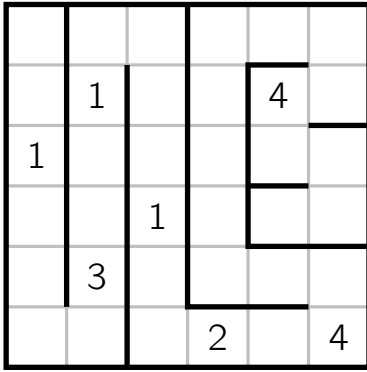

16

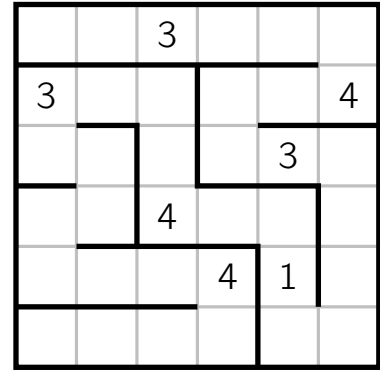

12

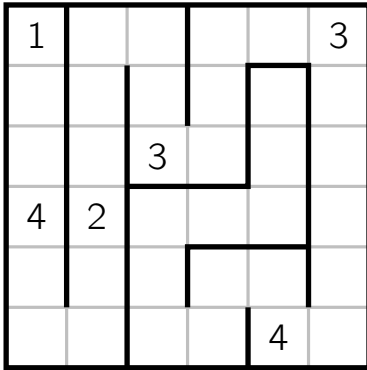

17

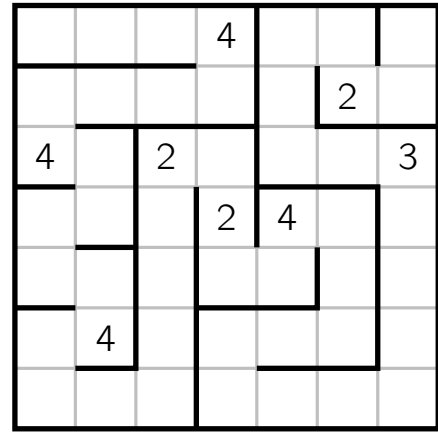

13

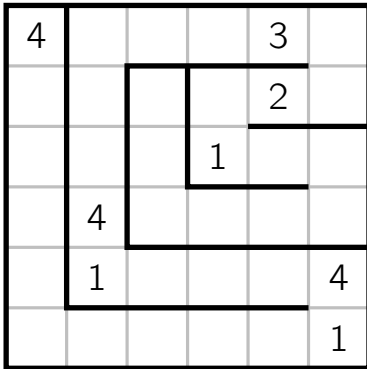

18

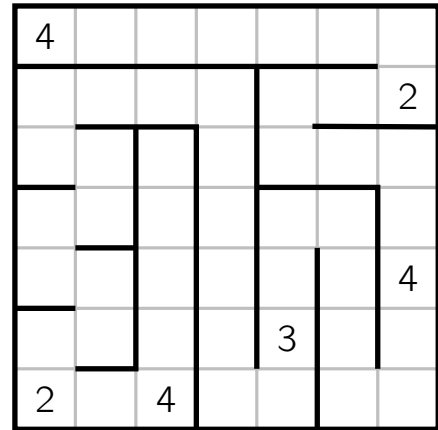

14

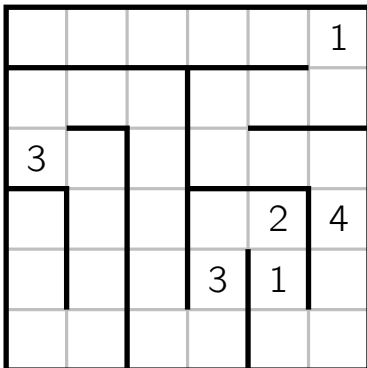

19

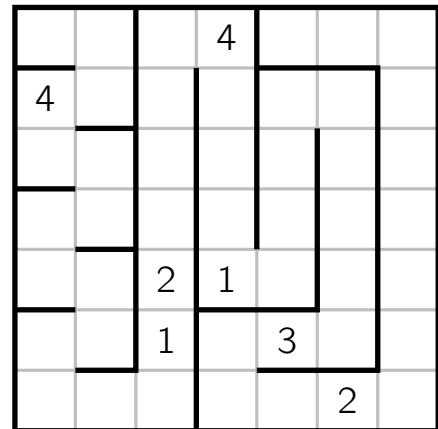

15

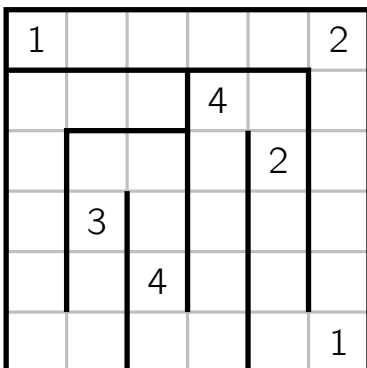

# Serpent — Snake — Tunnel

## Niveau 1

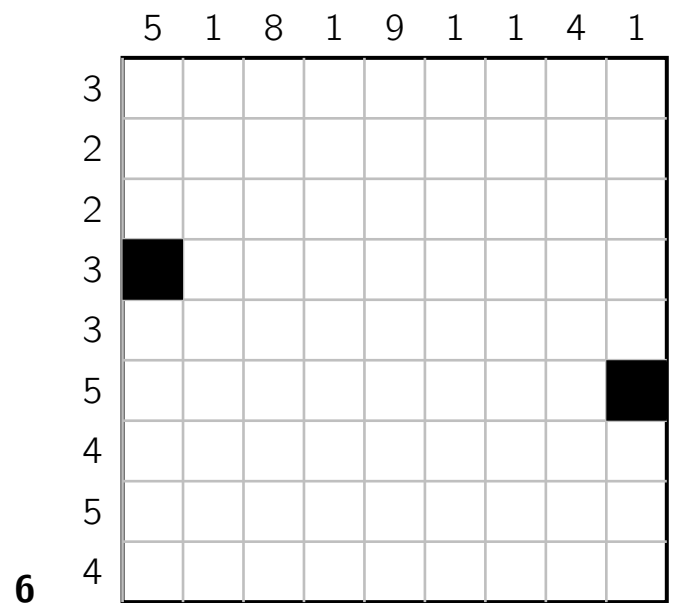
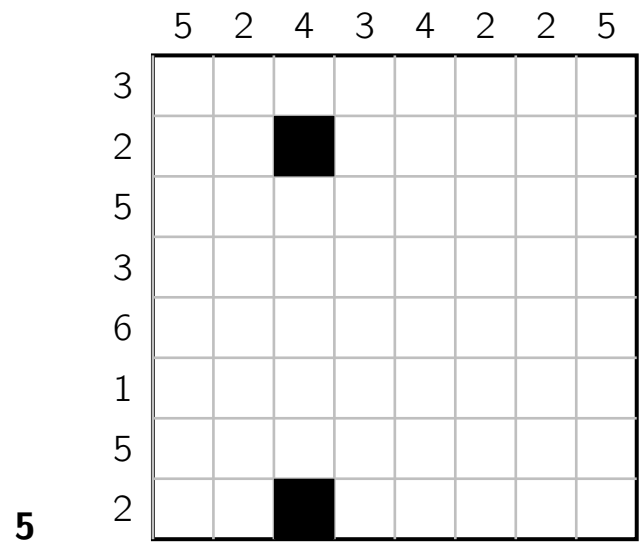
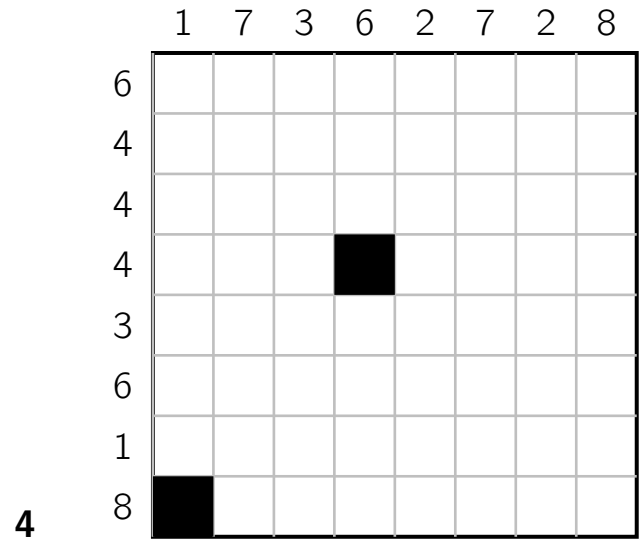
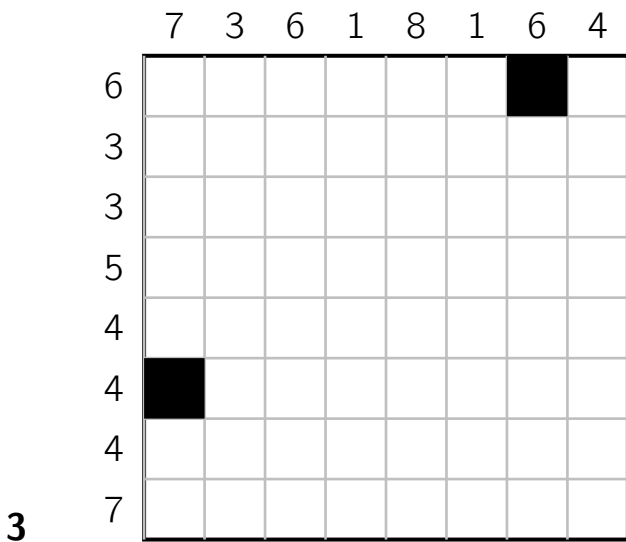
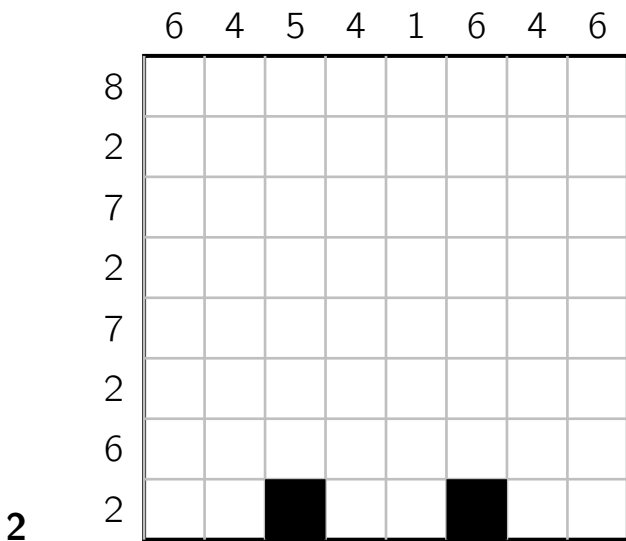
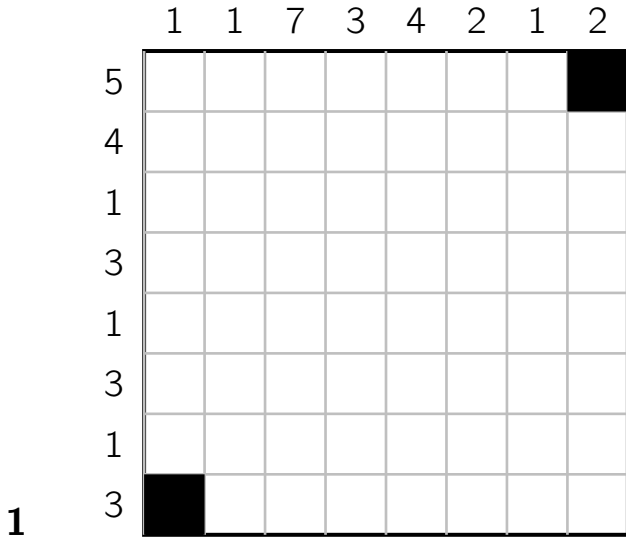



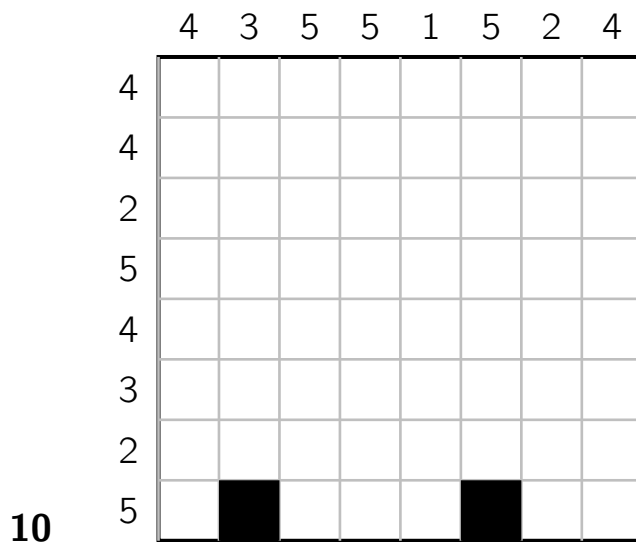
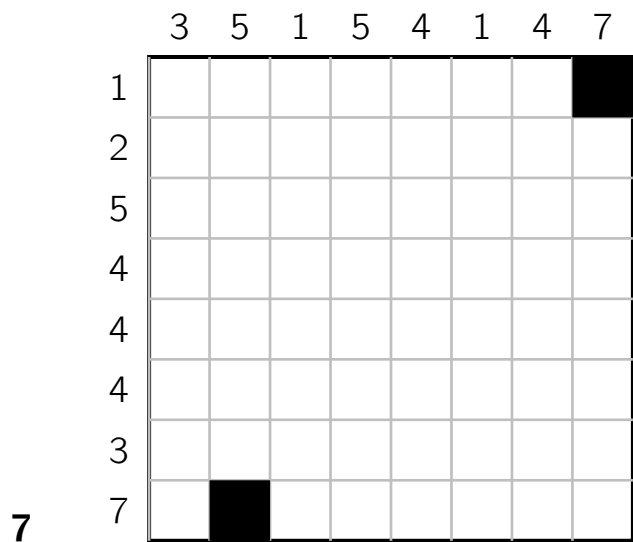

**Niveau 2**

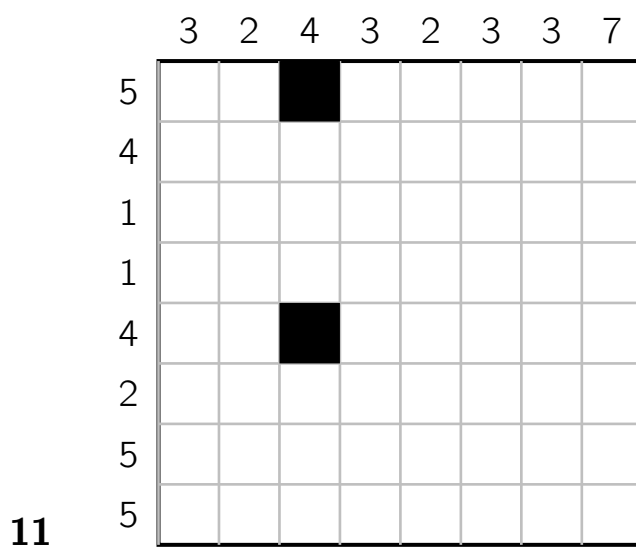
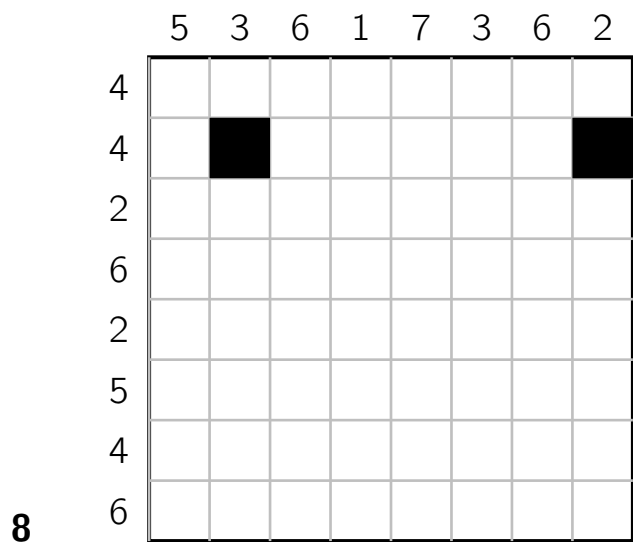

**Niveau 3**

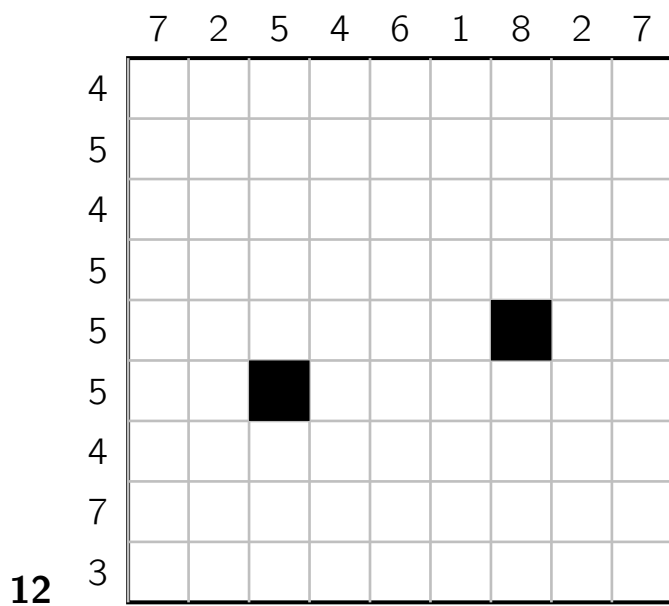
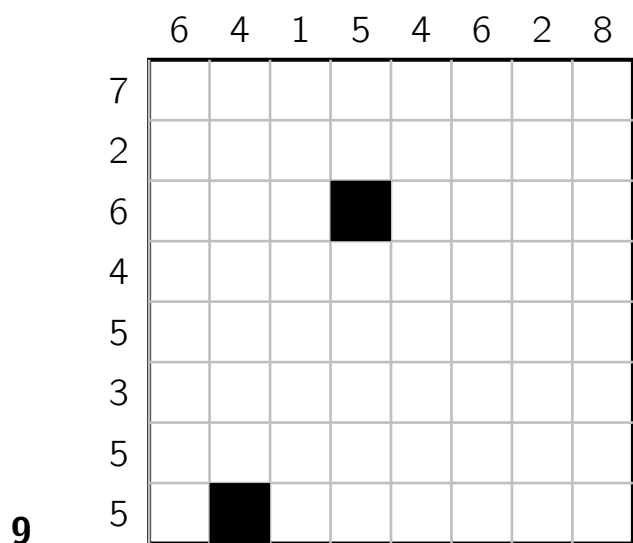





# Slant — Gogiken Naname

## Niveau 1

1

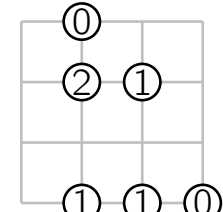

2

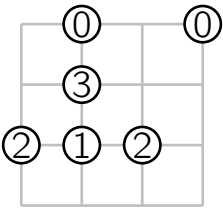

3

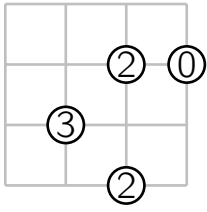

4

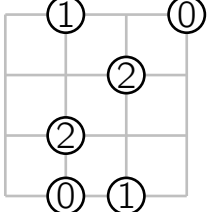

5

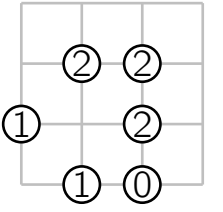

6

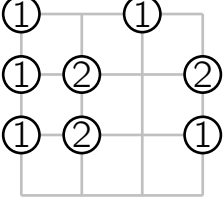

7

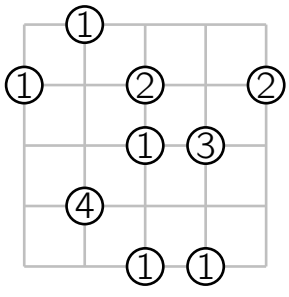

8

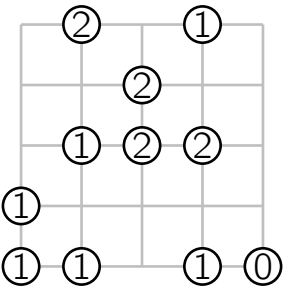

9

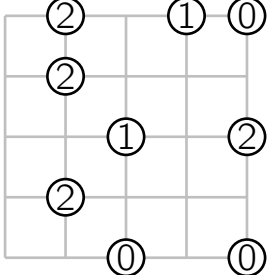

10

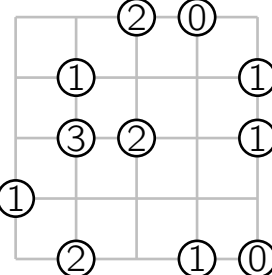

11

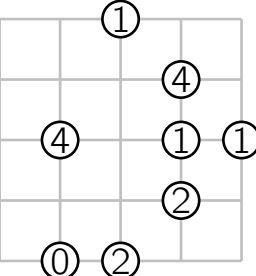

12

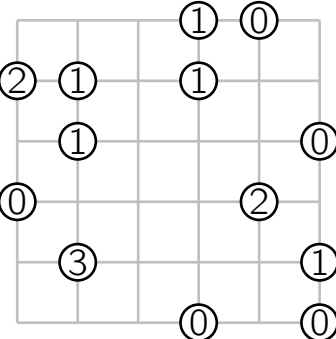

13

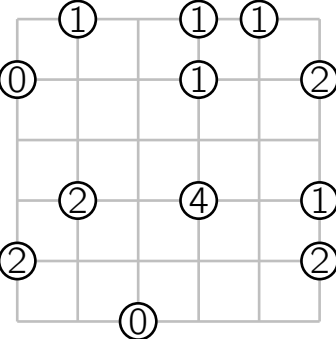

14

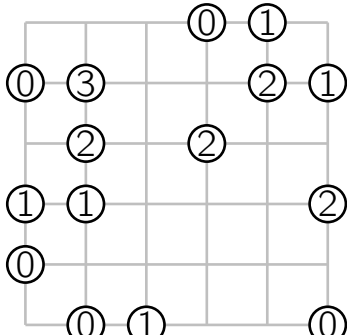

20

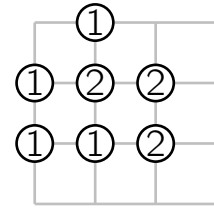

21

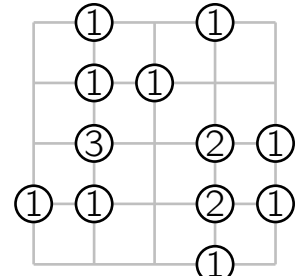

15

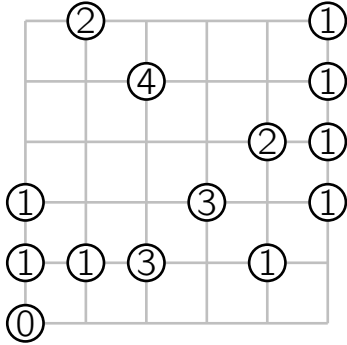

22

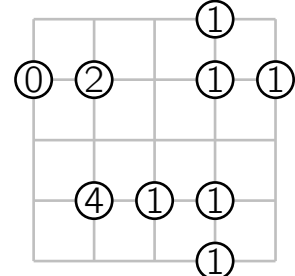

16

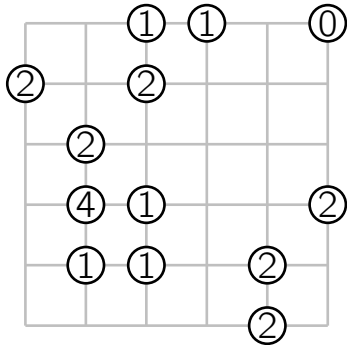

23

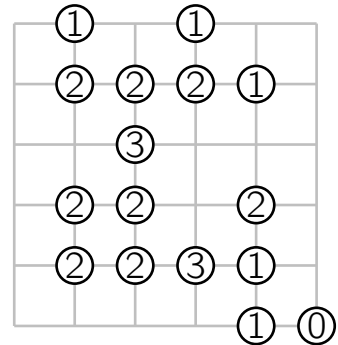

Niveau 2

17

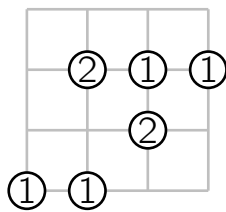

24

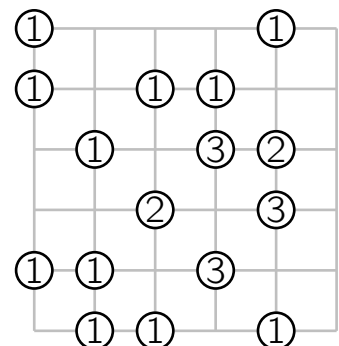

18

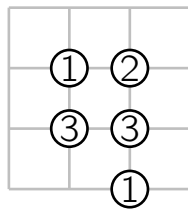

25

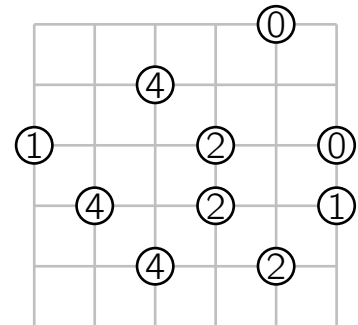

19

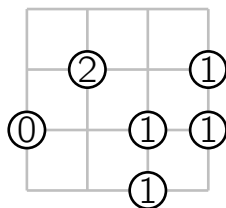

# Squaro

## Niveau 1

1

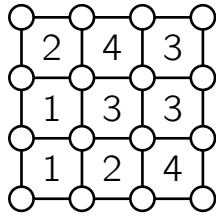

2

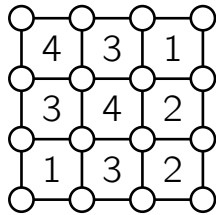

3

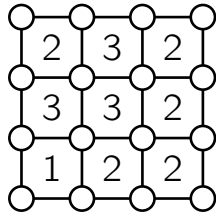

4

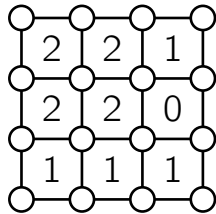

5

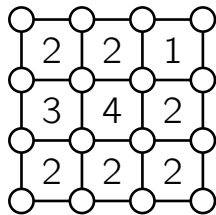

6

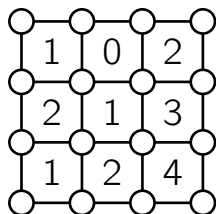

7

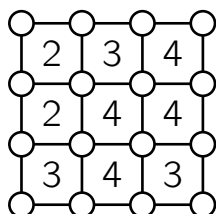

## Niveau 2

8

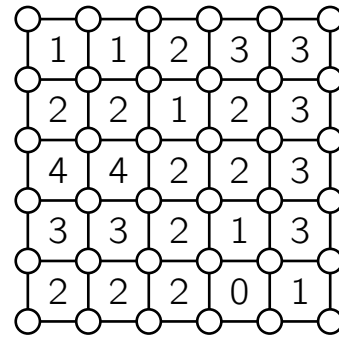

9

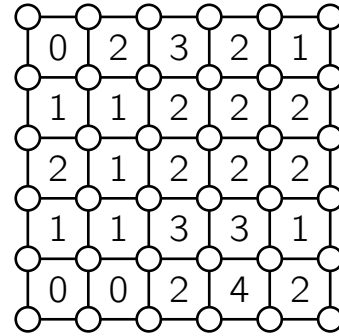

10

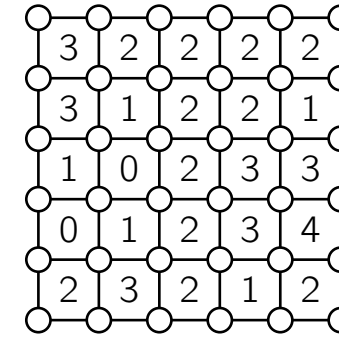

11

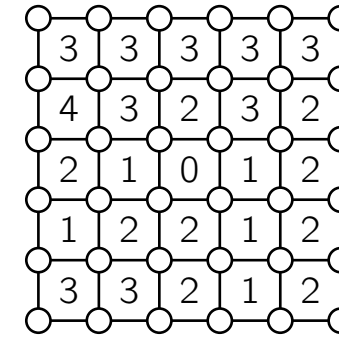

12

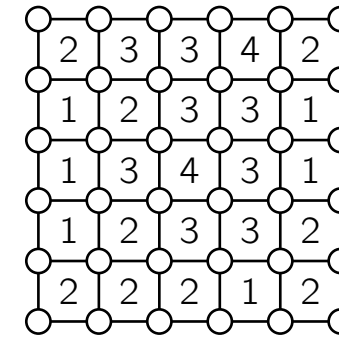

Niveau 3

13

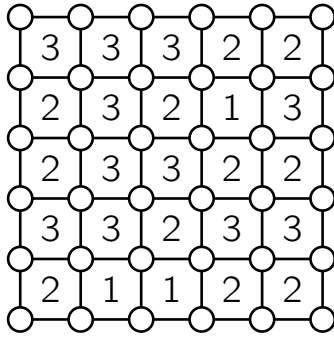

14

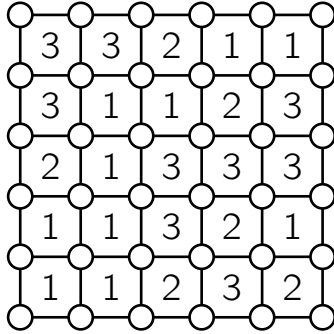

15

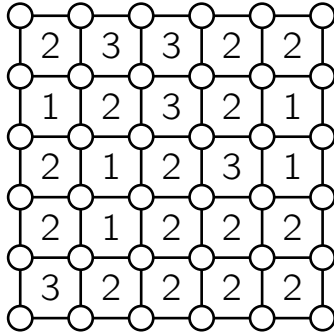

16

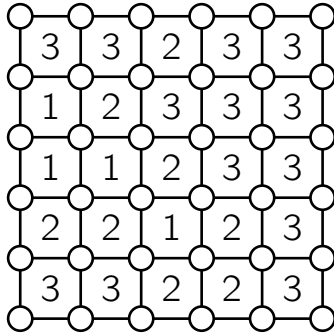

17

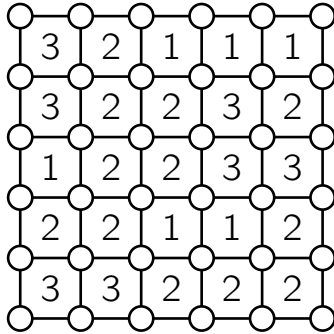

Niveau 4

18

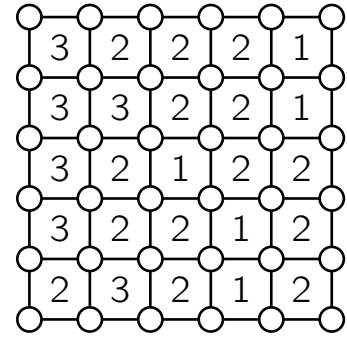

19

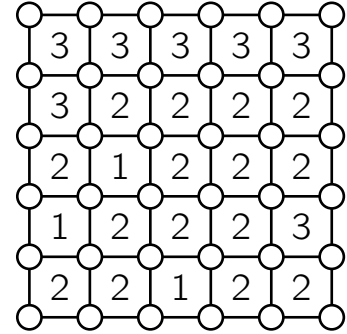

20

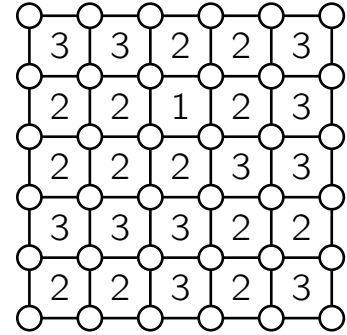

21

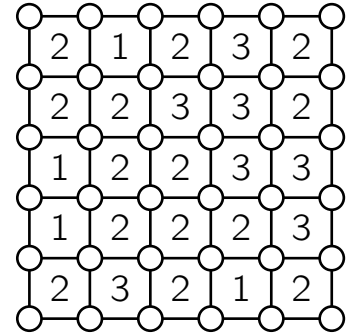

22

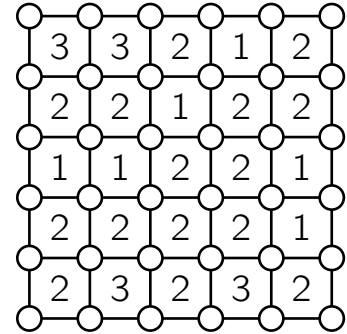

# Star

## Niveau 1

1

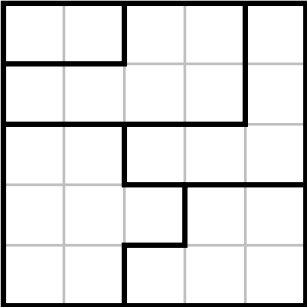

2

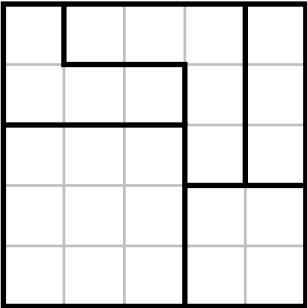

3

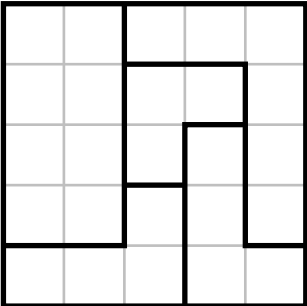

4

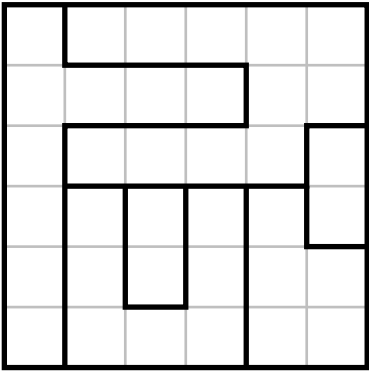

5

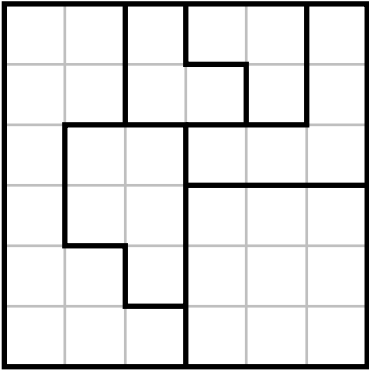

6

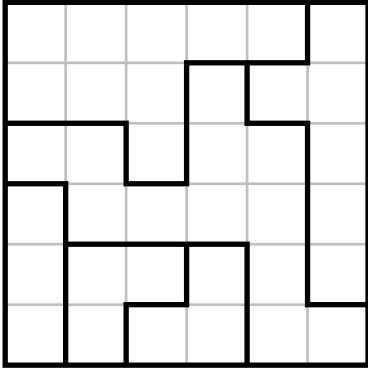

7

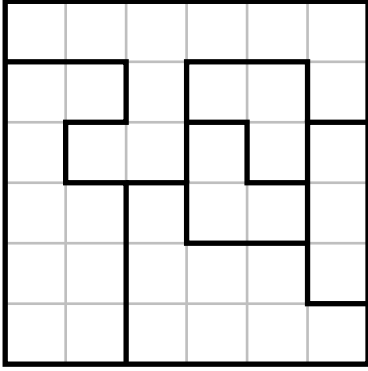

## Niveau 2

8

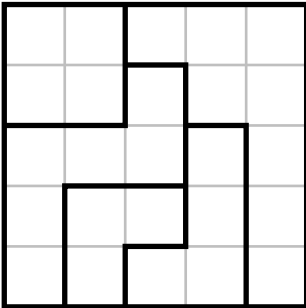

9

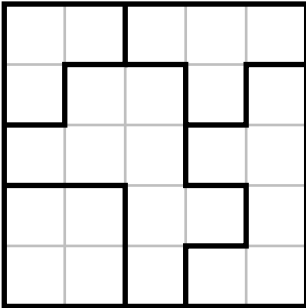

10

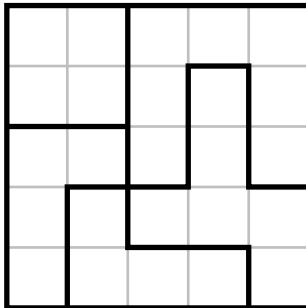



11

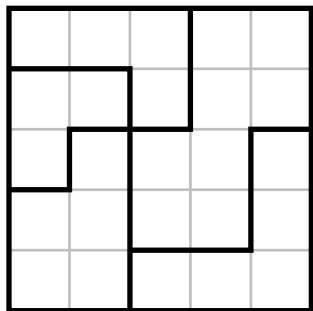

16

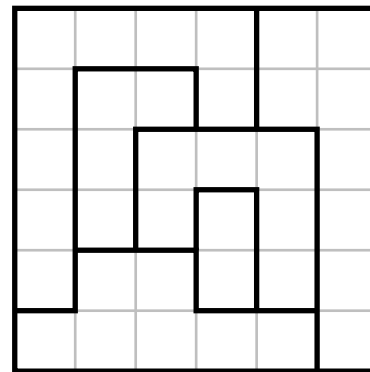

12

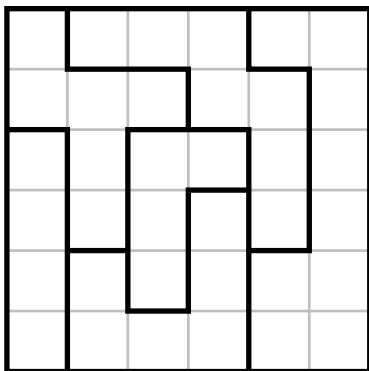

Niveau 3

13

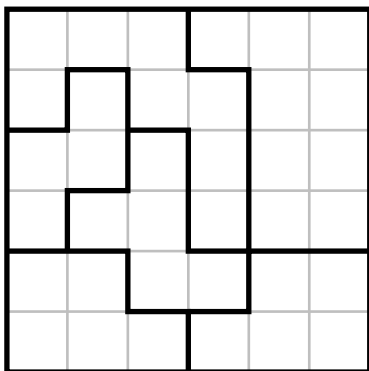

17

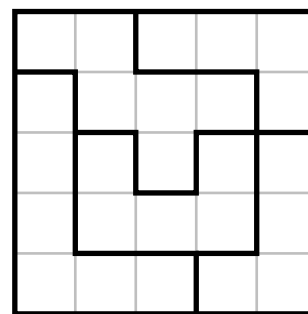

14

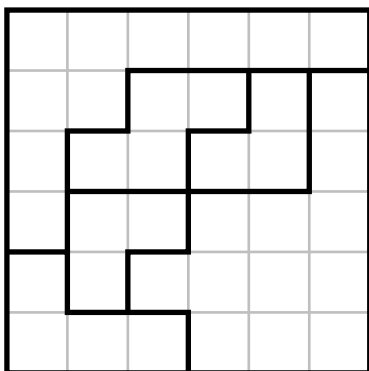

18

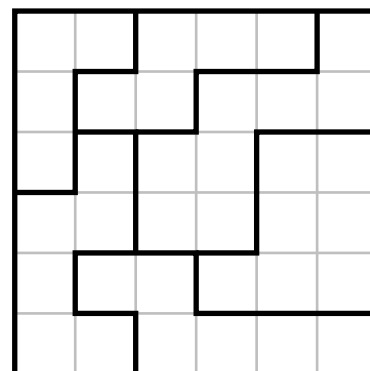

15

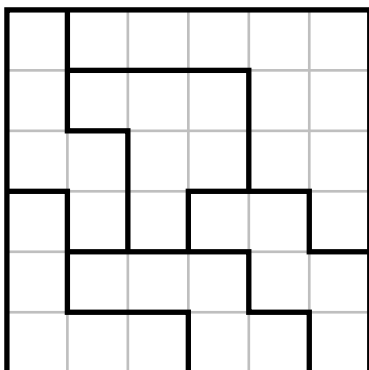

19

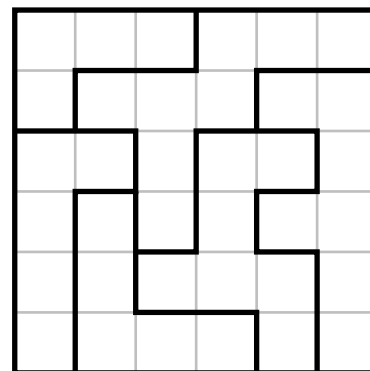

# Stitches

## Niveau 1

1

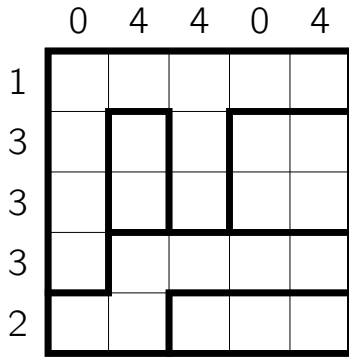

2

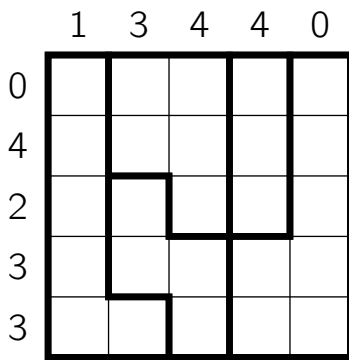

## Niveau 2

3

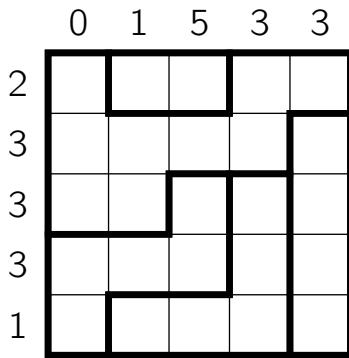

4

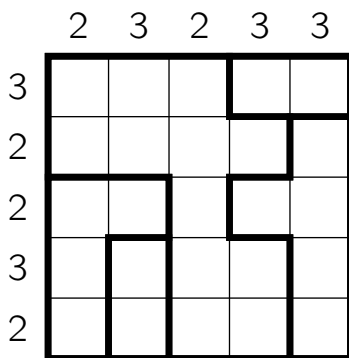

5

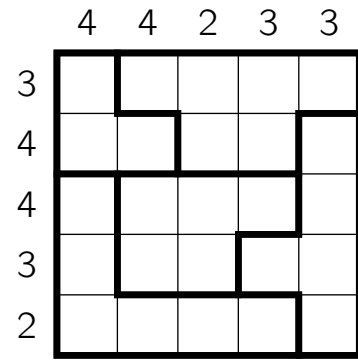

6

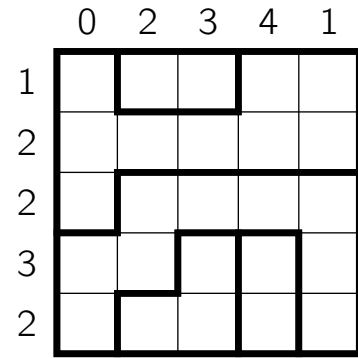

7

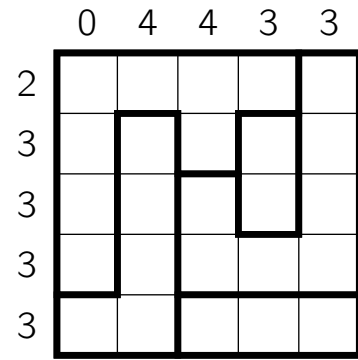

8

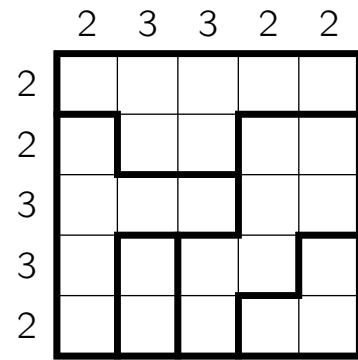

9

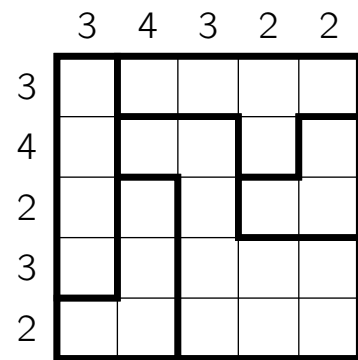

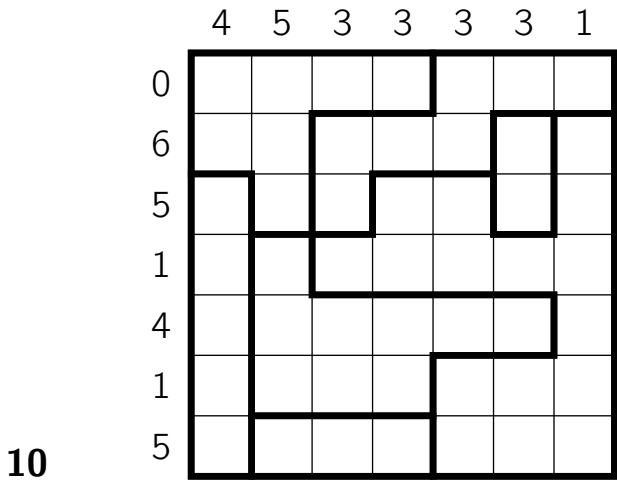

10

Niveau 3

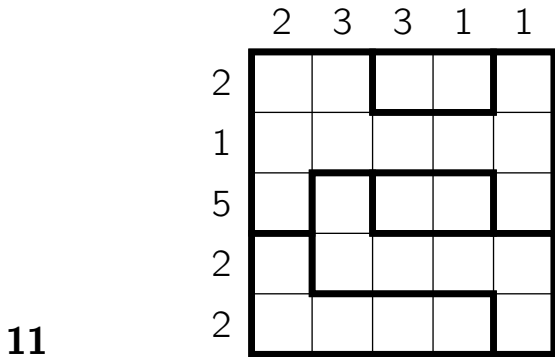

11

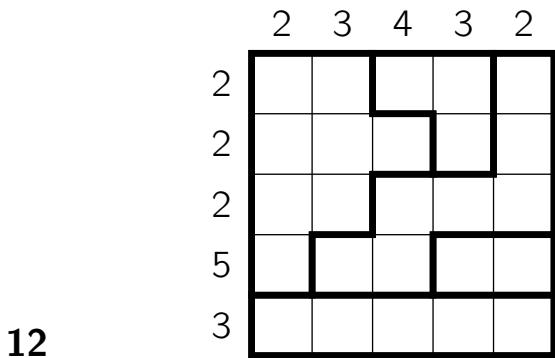

12

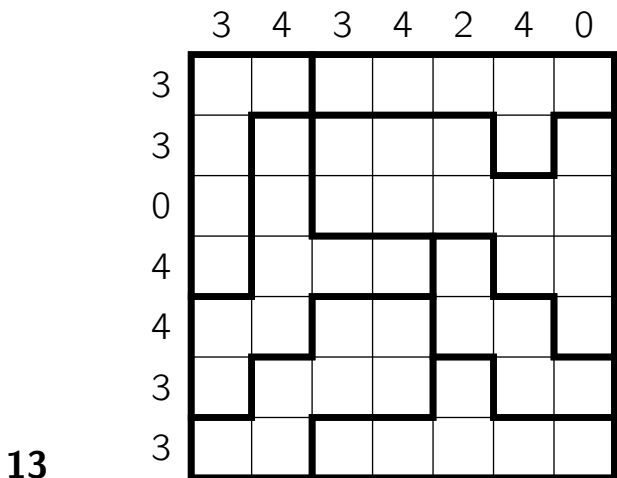

13

14

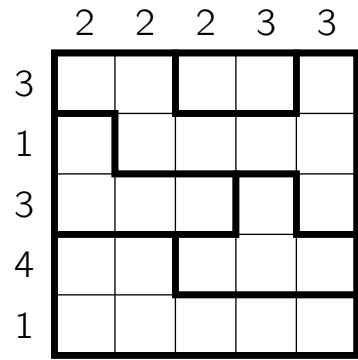

15

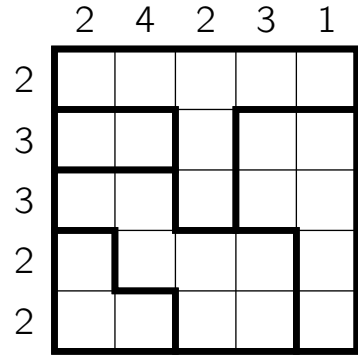

16

Niveau 4

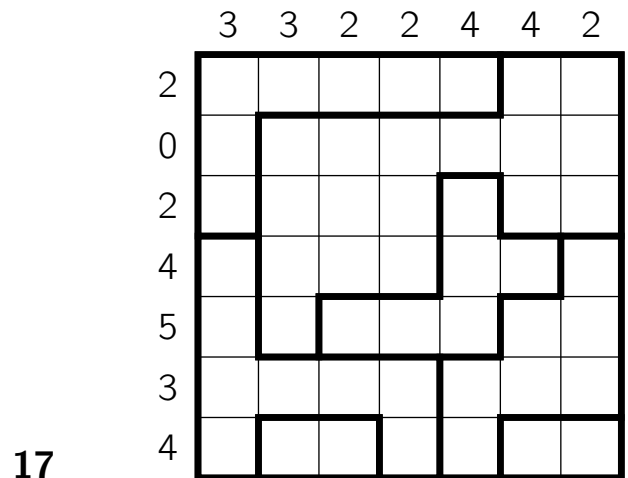

17

# Sudoku

## Niveau 1

1

	6			9			5	
7		1				2		9
	8		2		1		4	
		9	6	7	3	4		
3			9		2			5
		6	8	5	4	9		
	4		7		9		3	
1		7				5		8
	9			8			2	

2

		1	8		4	3		
		3		6		4		
8	4		1		3		5	2
5		2				7		6
	3						2	
4		7				8		1
3	8		6		9		7	5
		5		4		1		
		9	2		5	6		

3

		2	4		7	9		
		5		9		8		
1	4						2	3
6			8	1	4			5
	5		9		6		3	
2			3	7	5			8
9	8						1	2
		3		8		4		
		4	6		2	3		

## Niveau 2

4

		6				1	8	
				8	7			6
	8					2	5	4
				1	8			
8	1		3		2		4	9
			7	5				
3	2	8					9	
4			9	3				
	9	7				4		

5

								6
4	8		6		5	7		
	6	1	7	9			3	8
6			2					
			9	8	7			
					4			5
2	4			7	3	1	6	
		7	8		6		5	2
3								

6

		6				1	8	
				8	7			6
	8					2	5	4
				1	8			
8	1		3		2		4	9
			7	5				
3	2	8					9	
4			9	3				
	9	7				4		

### Niveau 3

7

		2	5	1	7	9		
	5		6		4		1	
	9	8		7		2	4	
	2		4		6		5	
	7	4		5		3	9	
	8		3		5		2	
		3	7	4	2	5		

8

	1	5		3		9	8	
8				4				2
2			9		8			1
		3				2		
5	6						9	7
		2				1		
6			5		4			3
3				7				8
	5	7		8		6	1	

9

	7		5		4		6	
4								2
			2		9			
1		3		5		6		8
			8		7			
7		2		3		1		5
			6		8			
5								4
	9		1		5		3	

### Niveau 4

10

3								5
		2	8		7	3		
	1	4				9	7	
	9			1			2	
			7		2			
	8			4			3	
	4	6				8	9	
		8	4		3	1		
1								7

11

			7			1		
	2		5	9				
		4					3	
2			6		8		9	4
1			9		2			8
9	6		4		5			2
	7					2		
				5	4		8	
		9			7			

12

		6	3			9	8	
					1			7
		3	7			1		4
	1				6			
	4		5		7		3	
			4				7	
2		8			4	7		
9			2					
	5	4			3	6		

# Sukoro

## Niveau 1

1

1		1	4		1
2		3	4	2	
			3		
		3			

## Niveau 2

2

1	3				1
		4		3	2
1		2			
3				4	1
2					
				2	

3

	1		3		
					1
1		1		2	
		3	2	4	
2					
		1	2		1

4

			2		1
1	2		3		1
			2		
					3
1	2	3	2		

5

				2	
	2	1			
2					3
	2				
2	4				3
	2	3			

6

			1	2	
	1				
2		1			3
3	2				2
		2			
				3	1

7

		2	1			
	1	3				1
				1		
	1				3	3
1		1		3		3
	2				2	
	4	2		2		
	2	3			2	1

8

	3	2	3		1	
3						2
				1		2
	2			3		4
	4	2		2		2
	1		2			
		1	4		1	

1		2		1			
	2	3	2	3			
2		1		3	2		
				4			1
1		3	2		2	3	
					3	2	

9

Niveau 3

					1
		2			
				2	
1					
	2				1
2	3			1	

10

		1		2	
1					
		1			
		3			2
					3
	1		2		

11

			1	3	
	1			2	
	4				
					3
	3			2	

12

	2	3			
2				2	
1					2
		2	4		
	2	4			1
1	3				

13

	1			3	
1	4				
	2			3	2
1	4				3
					2
1			1		

14

	2			3		1	
1		4		4			
		1			4		3
				4			1
1			3				
3			2				
						1	

15

Niveau 4

		1			2	3	2
1							
		3	2	3			2
2		2		2			3
				3			
						2	
		1		2		1	
	1		2				

16

# Tairupeto

## Niveau 1

7 7 7 4 3 4 4 8 6 3

1

A 9x9 grid for a Level 1 Sudoku puzzle. The top row contains the numbers 7, 7, 7, 4, 3, 4, 4, 8, 6, 3. The grid is partially filled with numbers, and the rest of the cells are empty for the player to solve.

3 3 7 5 3 5 8 7 6 5

2

A 9x9 grid for a Level 1 Sudoku puzzle. The top row contains the numbers 3, 3, 7, 5, 3, 5, 8, 7, 6, 5. The grid is partially filled with numbers, and the rest of the cells are empty for the player to solve.

8 4 2 5 6 5 6 6 3 6

3

A 9x9 grid for a Level 1 Sudoku puzzle. The top row contains the numbers 8, 4, 2, 5, 6, 5, 6, 6, 3, 6. The grid is partially filled with numbers, and the rest of the cells are empty for the player to solve.

8 5 3

4

A 9x9 grid for a Level 1 Sudoku puzzle. The top row contains the numbers 8, 5, 3. The grid is partially filled with numbers, and the rest of the cells are empty for the player to solve.

7 8 3 4 3 6 5 5 6 3

5

A 9x9 grid for a Level 1 Sudoku puzzle. The top row contains the numbers 7, 8, 3, 4, 3, 6, 5, 5, 6, 3. The grid is partially filled with numbers, and the rest of the cells are empty for the player to solve.

1 6 5 3 4 7 8 6 4 8

6

A 9x9 grid for a Level 1 Sudoku puzzle. The top row contains the numbers 1, 6, 5, 3, 4, 7, 8, 6, 4, 8. The grid is partially filled with numbers, and the rest of the cells are empty for the player to solve.



**Niveau 2**

5 2 7 4 3 4 8

5  
8  
4

4  
4  
6

**7**

2 8 8 5

5  
7  
4  
7  
6  
3

**10**

7 4 5 3 7 6 7 5 5 4

5  
5  
6  
2  
4  
6  
8  
7  
8  
2

**8**

8 3 3 8 7

5  
4  
4  
5  
5  
4

**11**

**9**

5 9 4 4 7 7

7  
6  
3  
4  
4

**12**

# Tentes

## Niveau 1

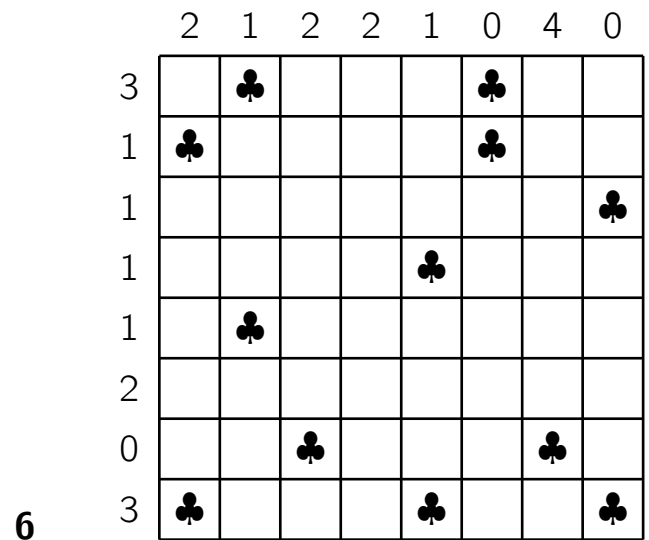
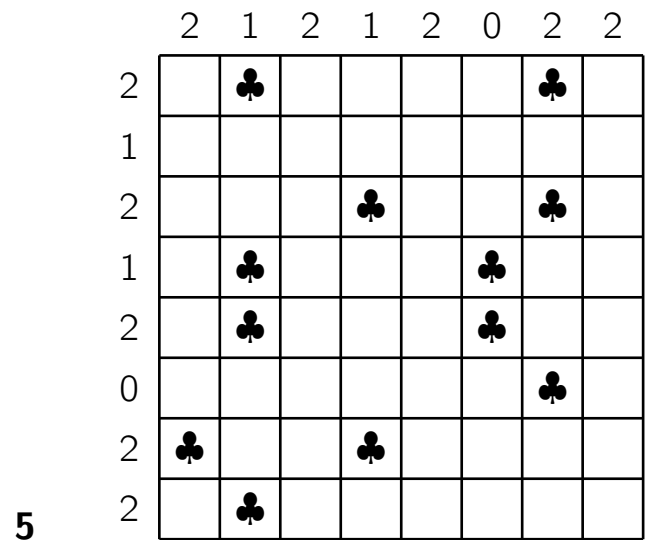
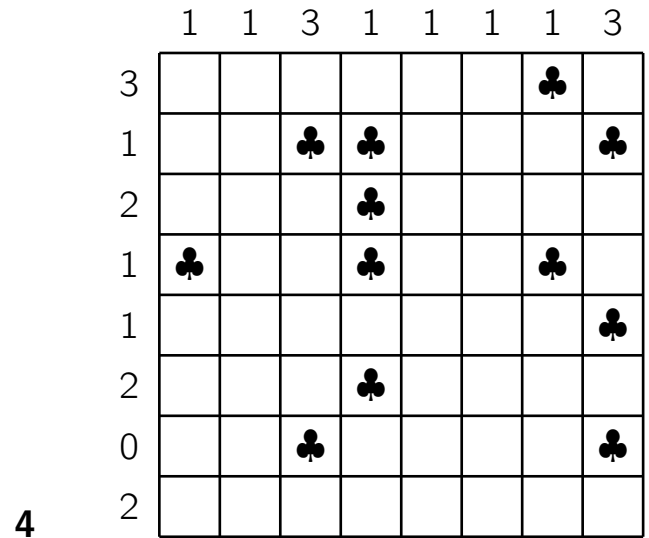
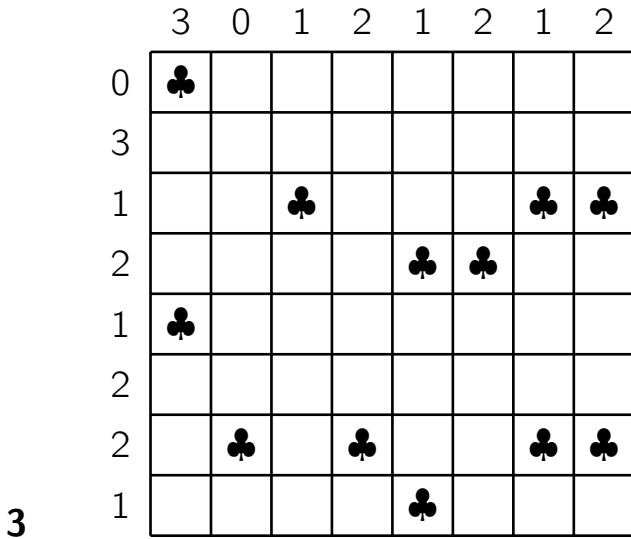
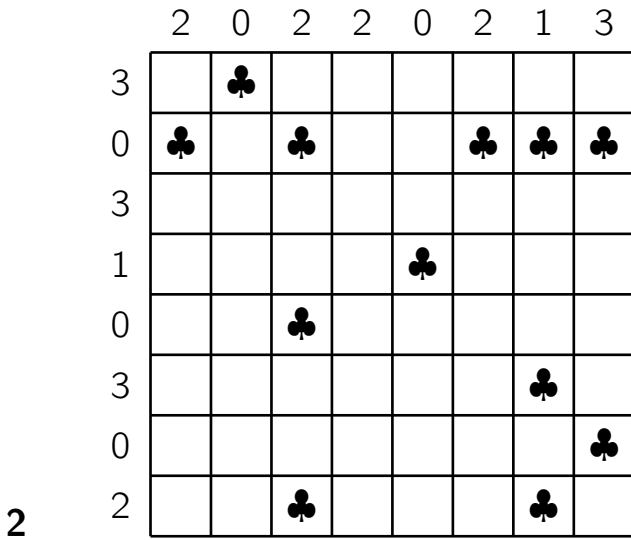
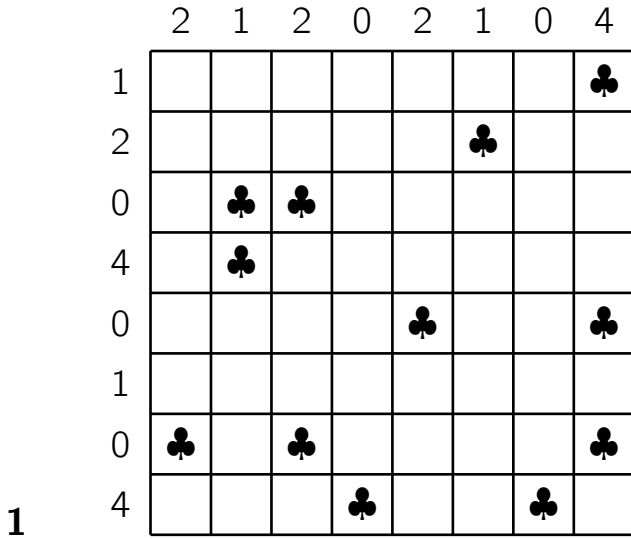

# Niveau 2

7

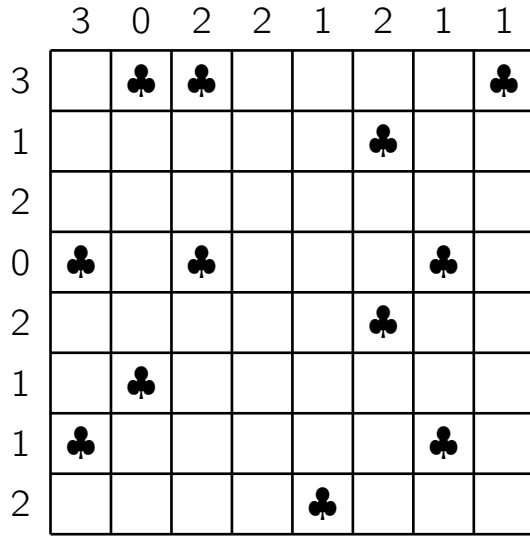

10

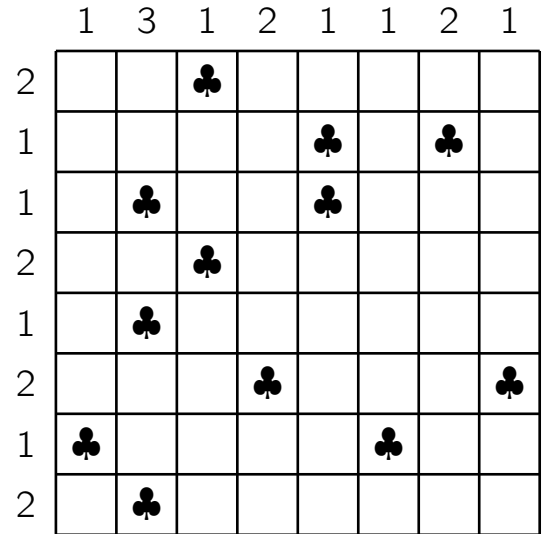

8

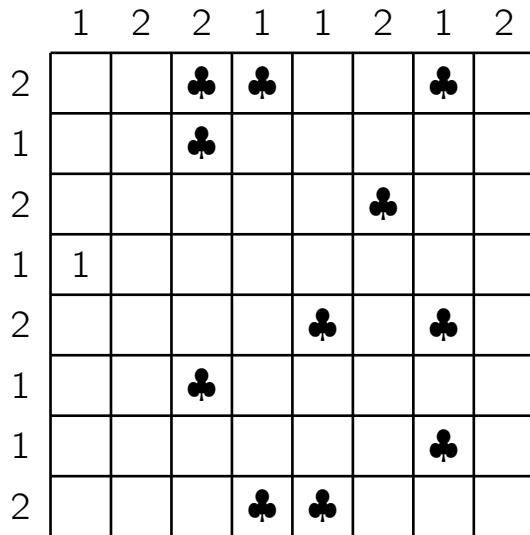

11

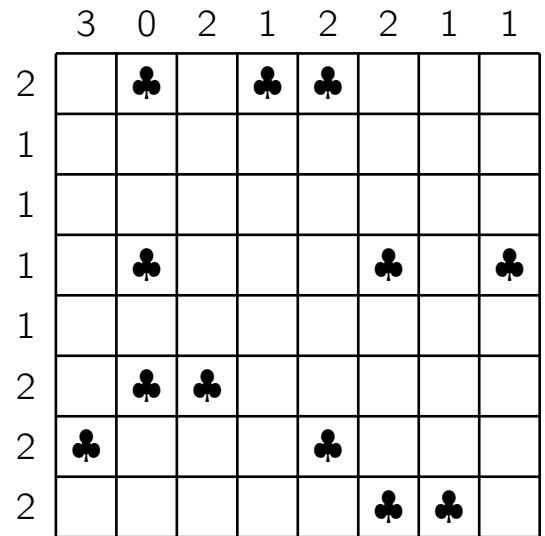

9

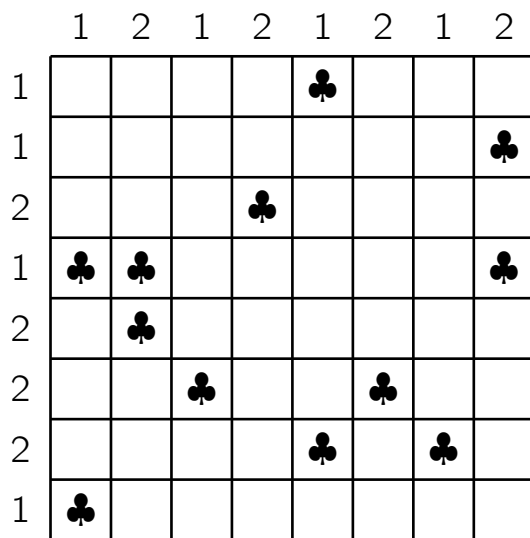

12

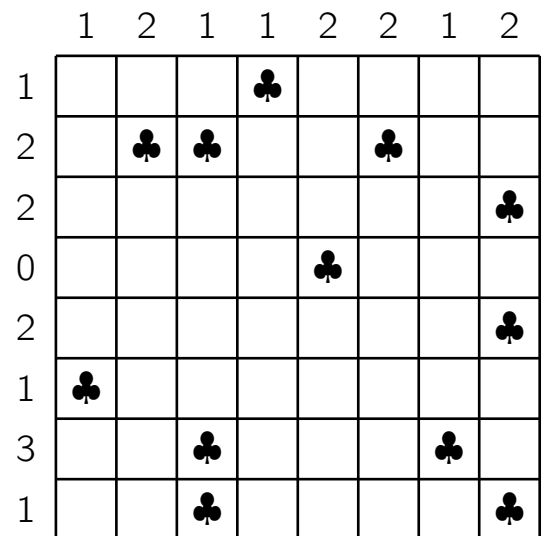

# Tetroid

## Niveau 1

1

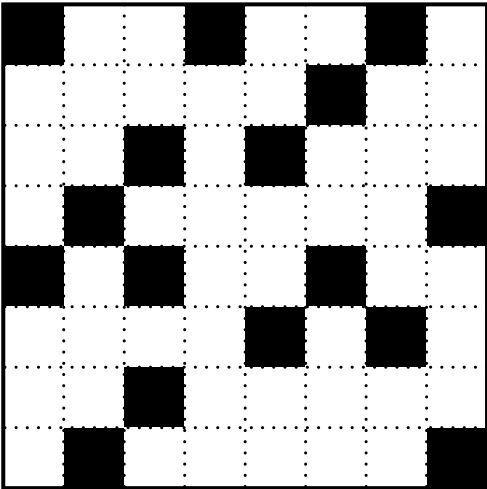

2

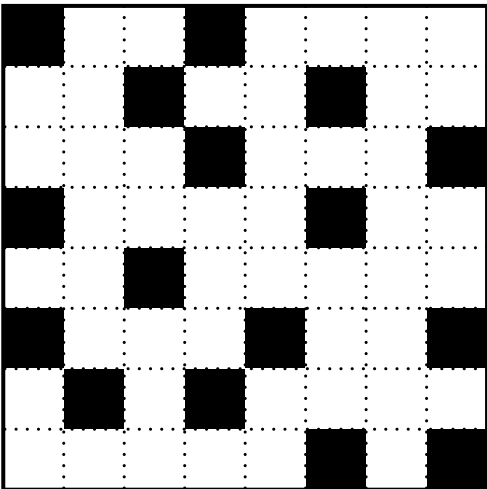

3

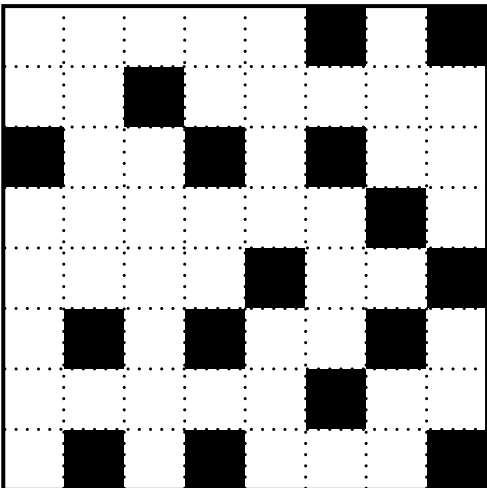

4

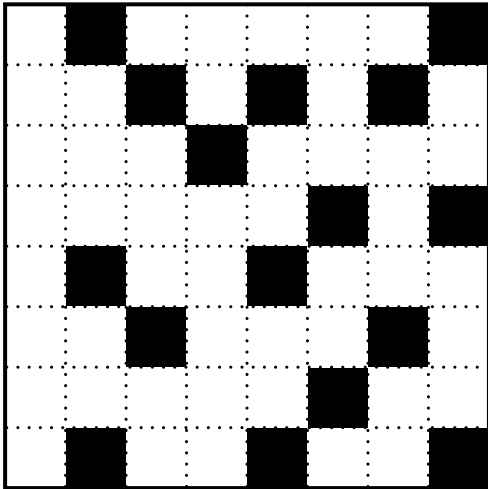

5

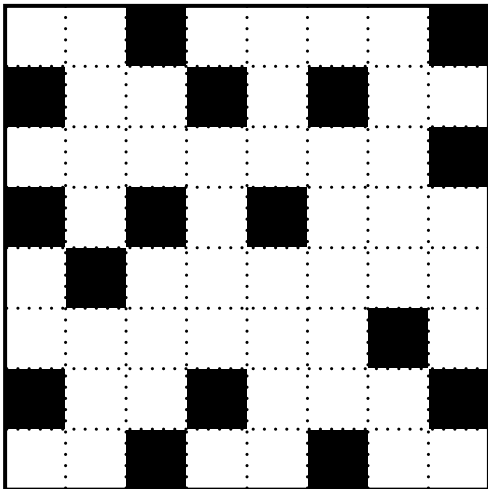

6

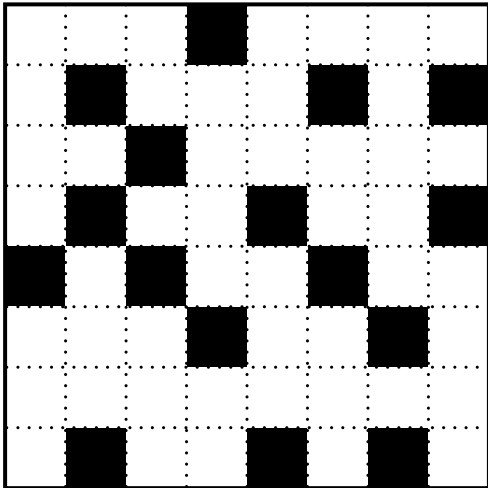

7

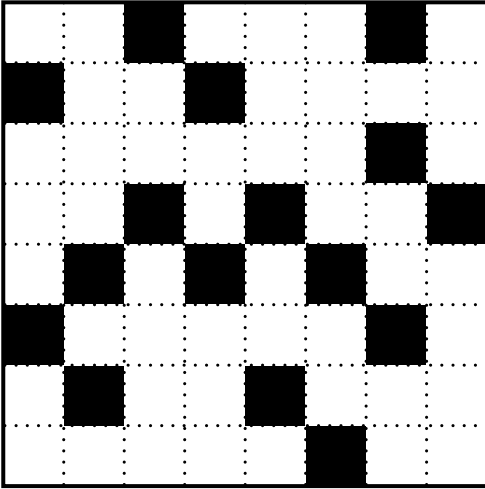

10

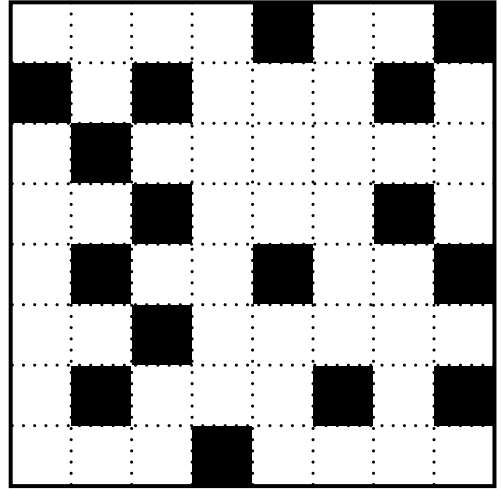

8

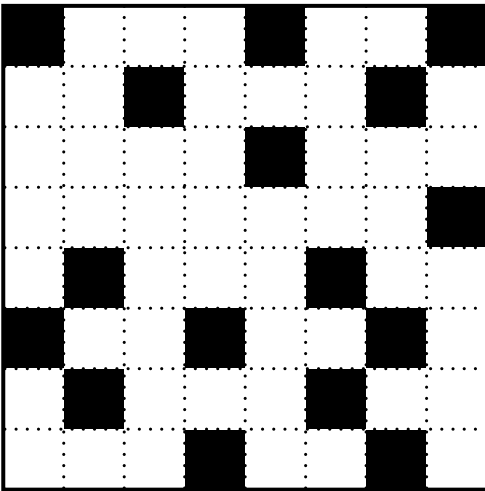

Niveau 3

Niveau 2

11

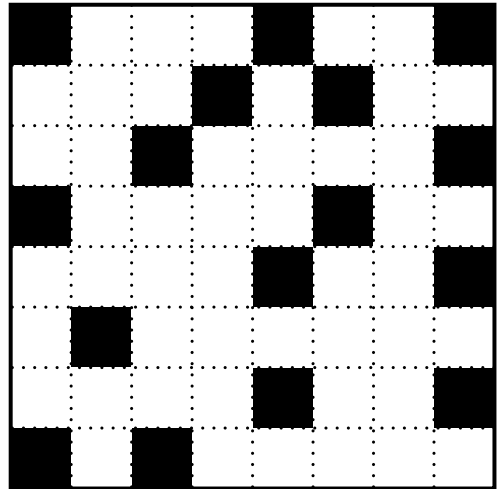

9

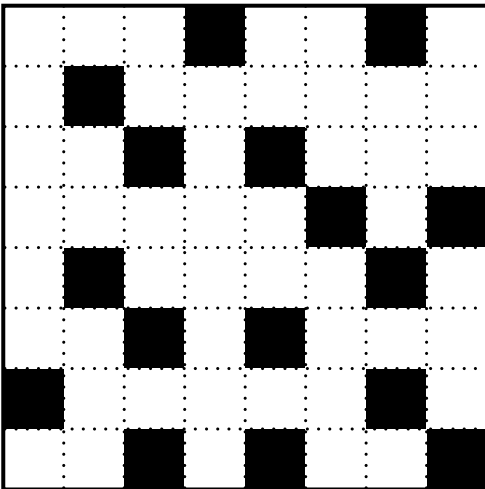

12

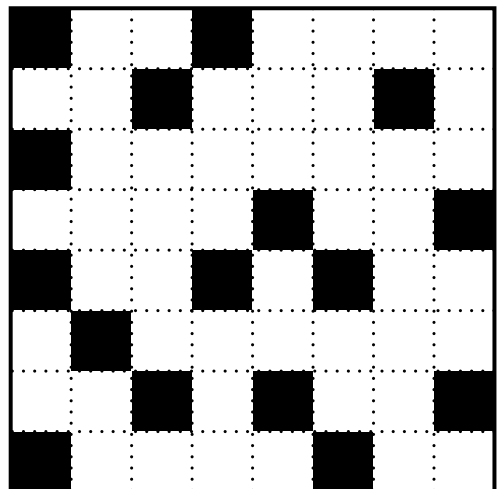

# Thermomètres

## Niveau 1

1

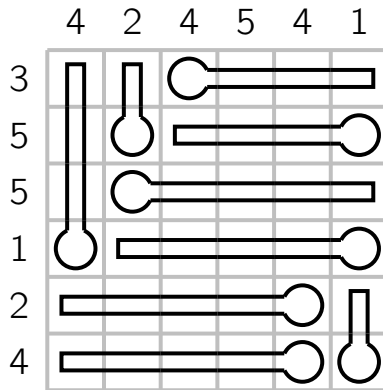

2

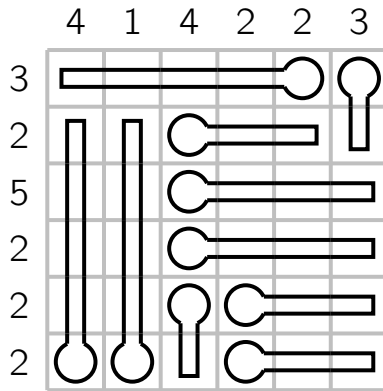

3

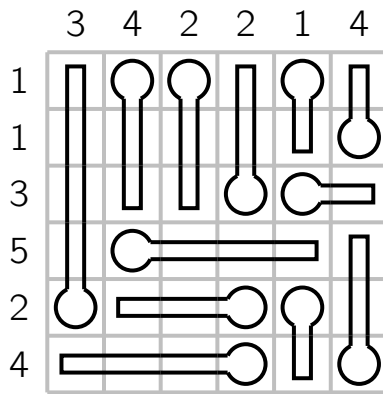

4

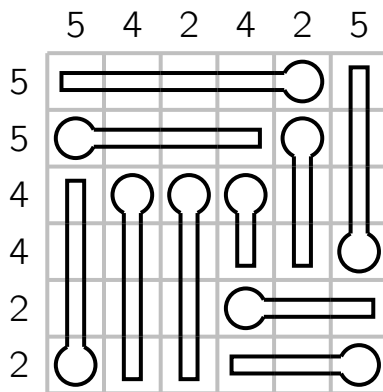

5

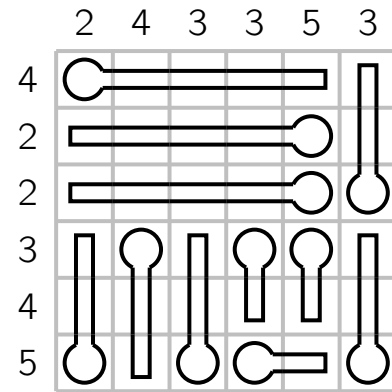

## Niveau 2

6

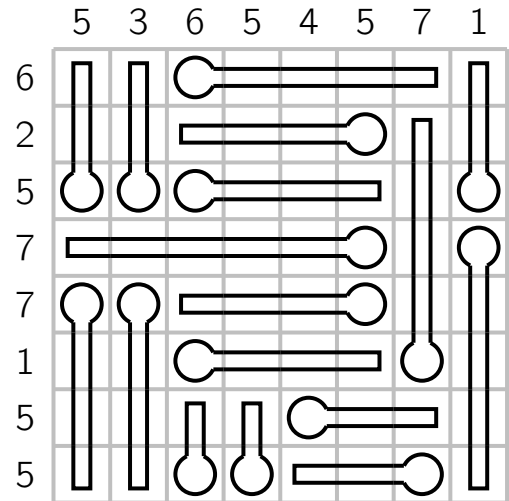

7

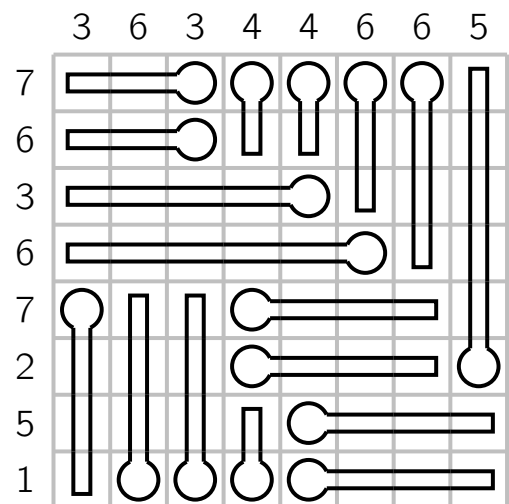

8

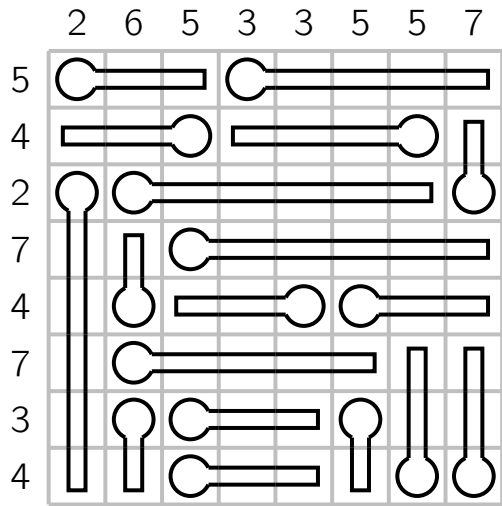

9

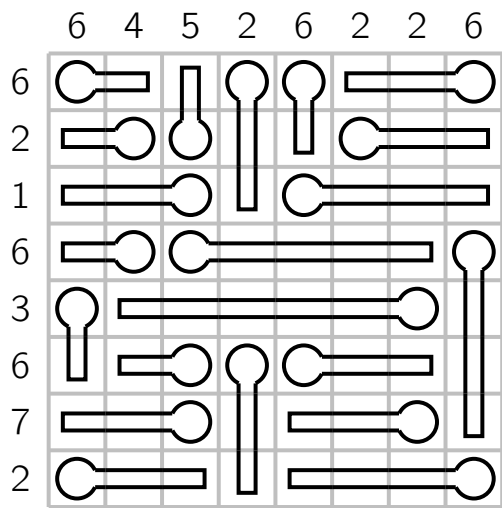

10

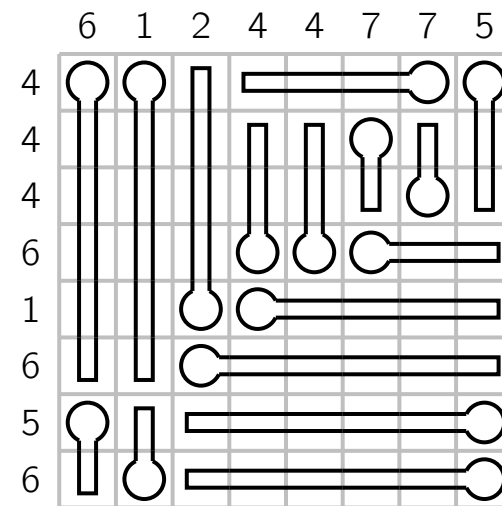

### Niveau 3

11

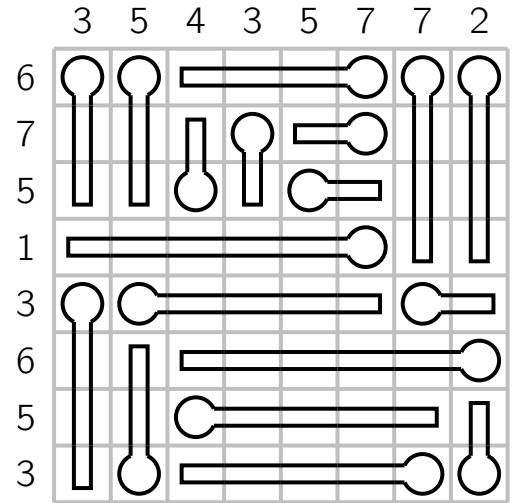

12

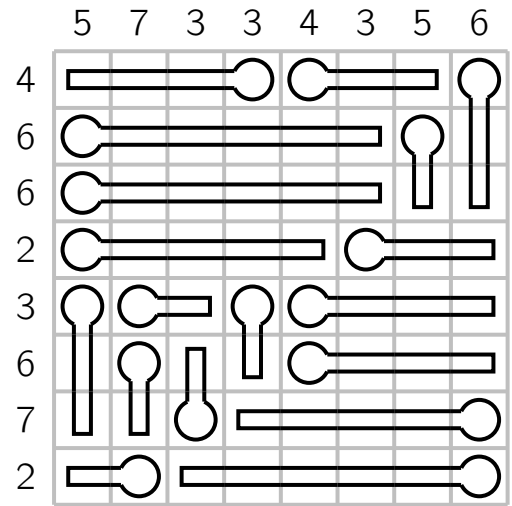

### Niveau 4

13

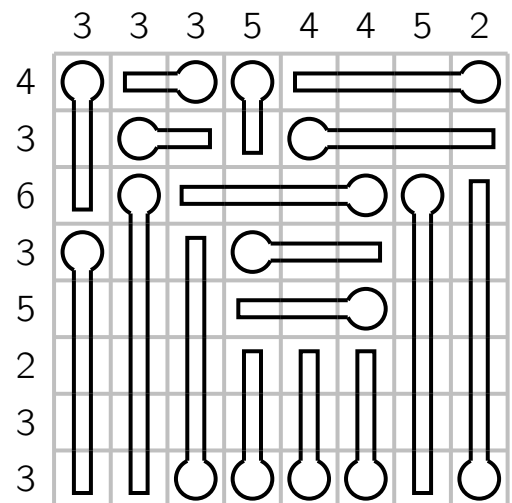

# Toichika

## Niveau 1

1

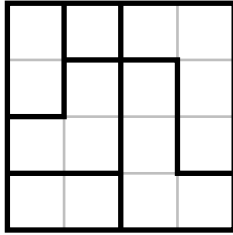

2

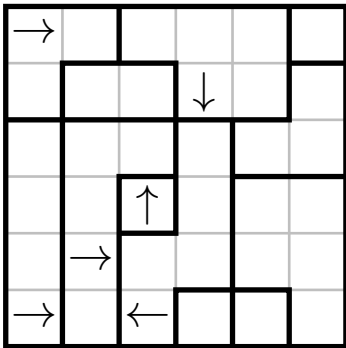

3

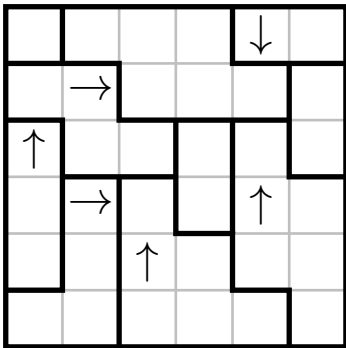

4

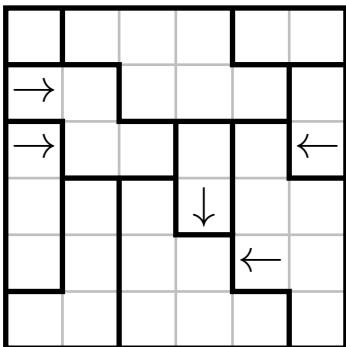

## Niveau 2

5

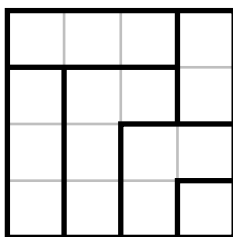

6

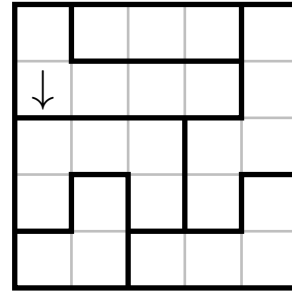

7

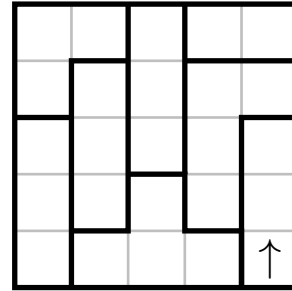

8

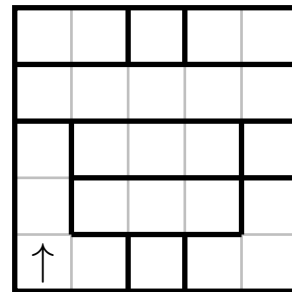

9

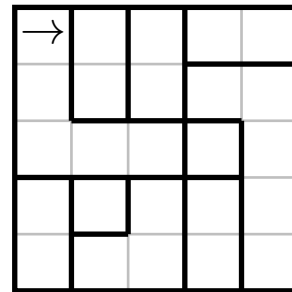

10

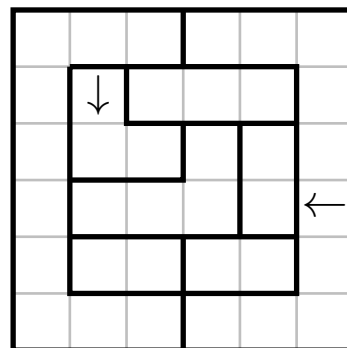



11

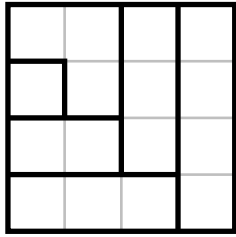

12

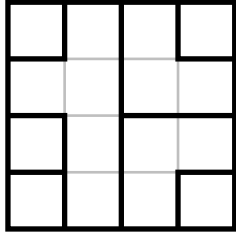

13

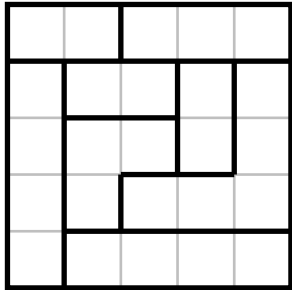

14

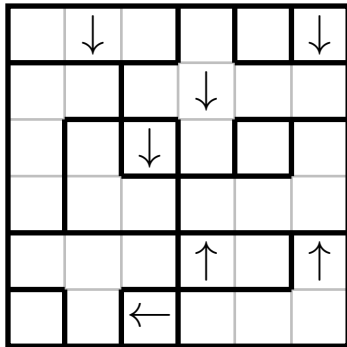

15

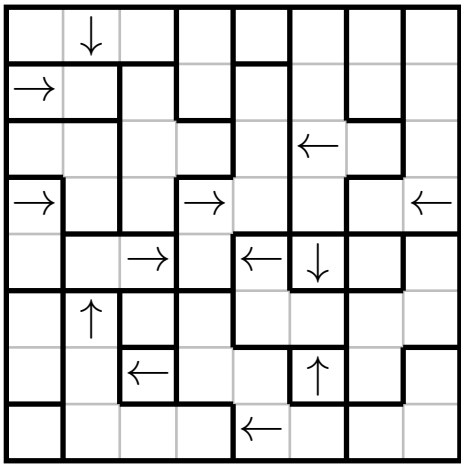

Niveau 3

16

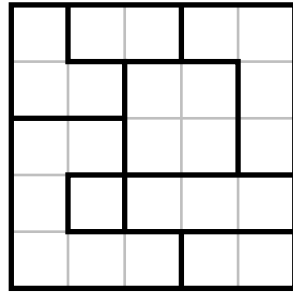

17

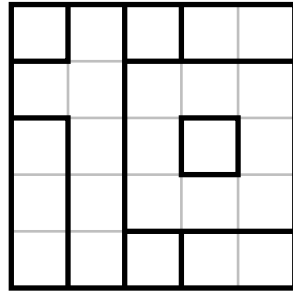

18

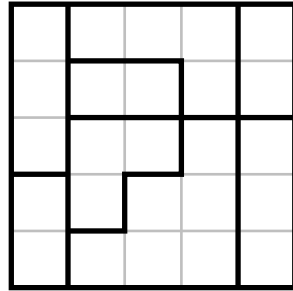

19

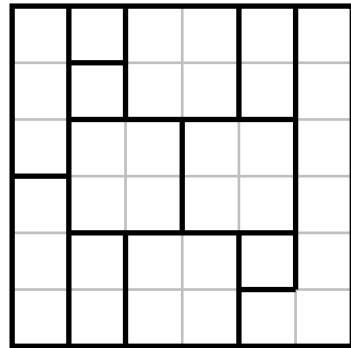

20

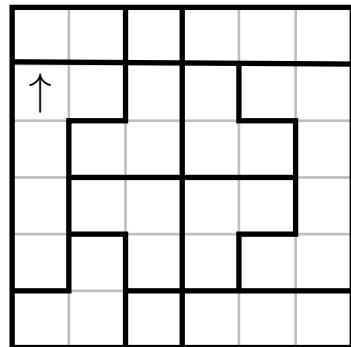

# Tra-vers

1

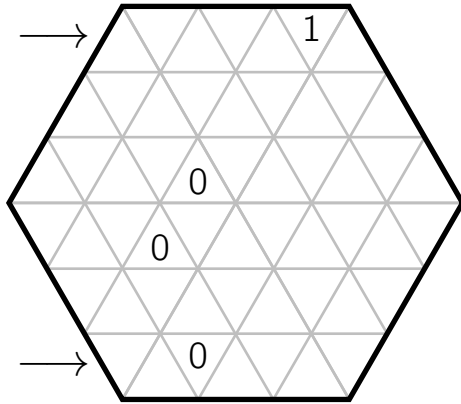

2

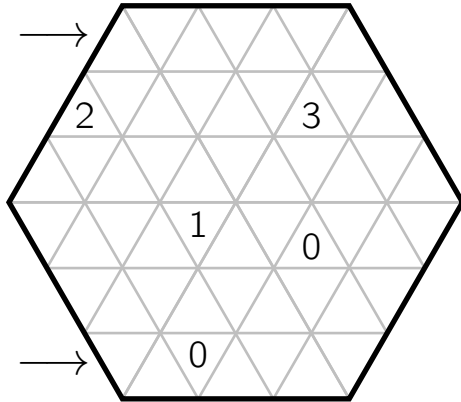

3

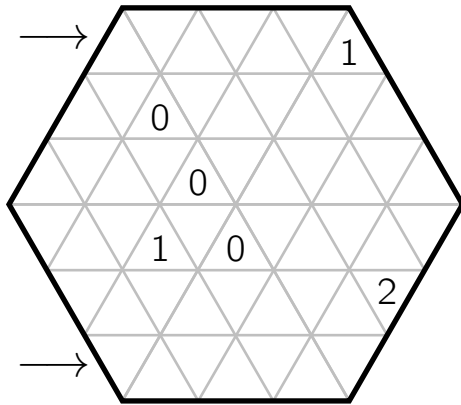

4

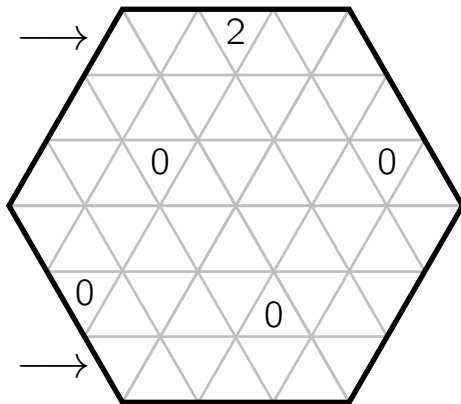

5

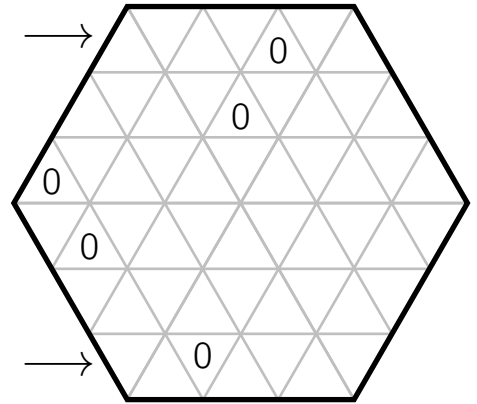

6

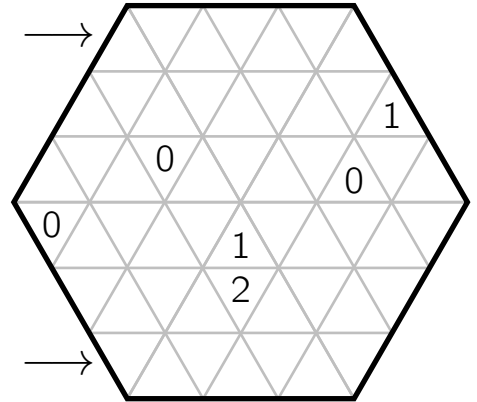

7

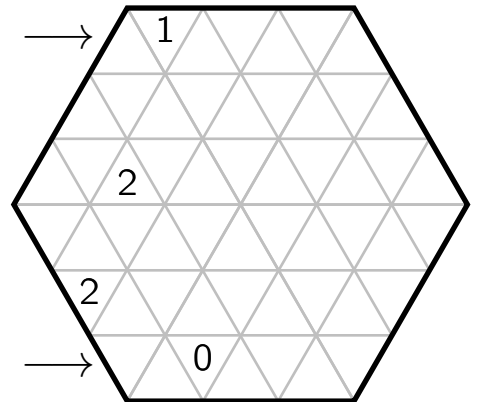

8

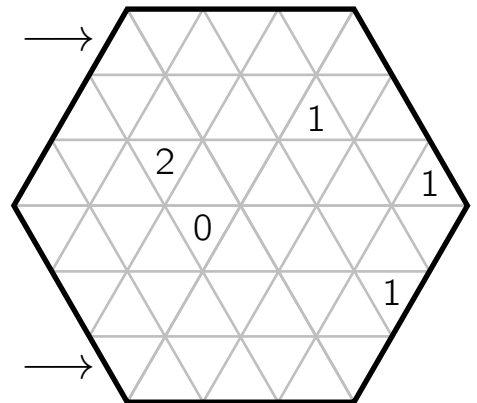

9

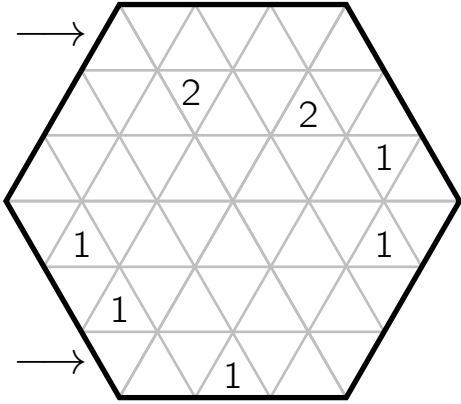

13

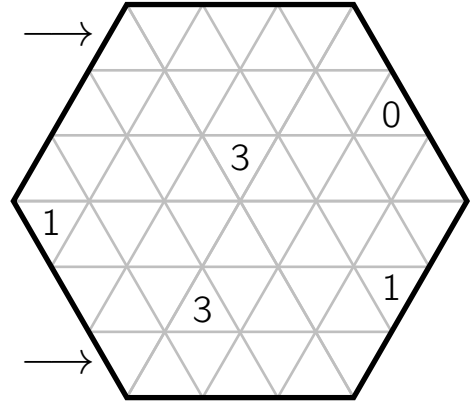

10

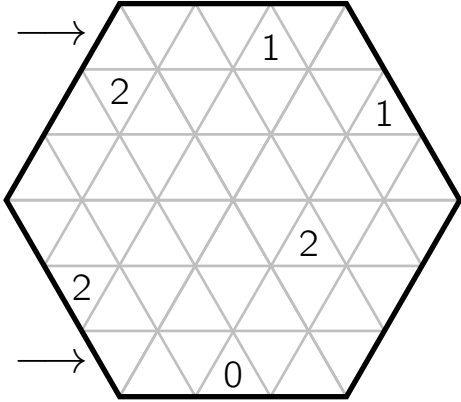

14

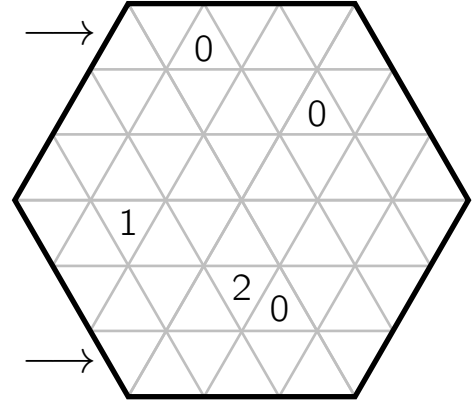

11

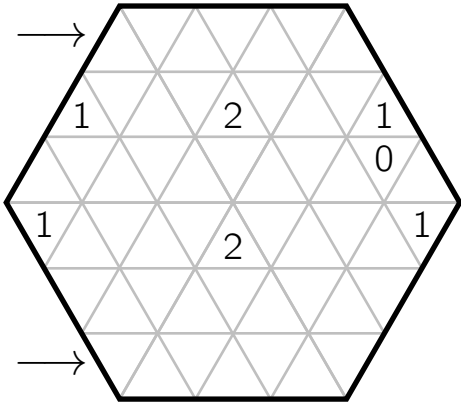

15

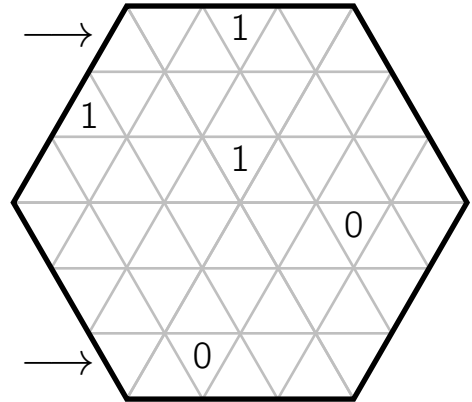

12

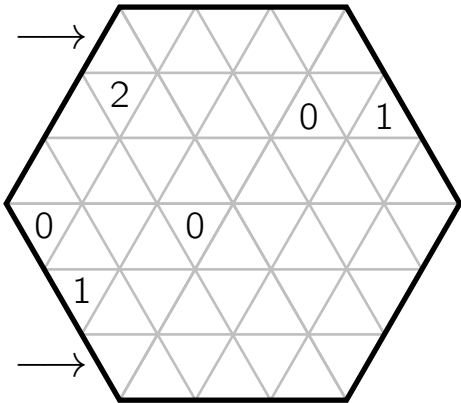

16

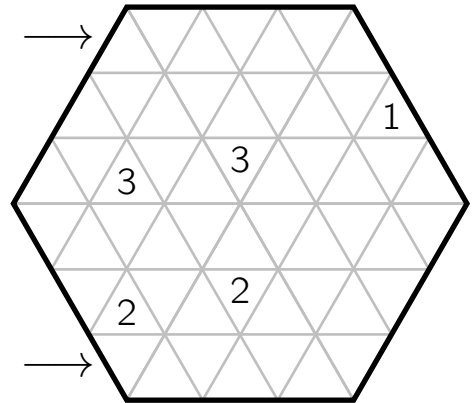

# Trace numbers

## Niveau 1

1

			2	4
	3		3	4
		1	2	1

## Niveau 2

2

2				2
			4	
	1	1		
			3	
4				3

3

	5	4	1	3
	4	5		
3				2
	2		1	

4

		2		
	1		3	1
3			2	3
	2			1

5

4				4
1		2		
	3		1	
			2	3

6

	2		2	
	3	1	1	
	4	3	4	

## Niveau 3

7

	4	4	3	
	2	1	2	
	1		3	

8

2	3			1
			3	
1		1		
				3
2			2	

9

	5	3		1
4			2	
5		3		
	4		2	
		1		

10

	1			
			2	1
	2	1		2
1		2		

11

	2		1	2
1			1	
2	2			1

12

	2	1		3	
		2		1	
	1				
3		2	3		

13

1					2
				1	
		1			1
					2
		2			
				2	

14

	2				
		1	1	3	
	2			3	
	4	4			

15

1	2		3	4	3	
			4			
	4			2		3
1		4				
					3	
			1		2	
1						2

16

1	4					3
	3				4	
			1			
			1	2		2
				2		1
	4	4		3		
2						3

17

1						4
		4			1	
3	2					
	4	1	3	3		
		2	2			

Niveau 4

18

	2	1	2		
			3	1	
	1				
3		2		3	

19

	2	2			
		1	1	1	
	3	3		2	
	3				

# Tripletts

## Niveau 1

1

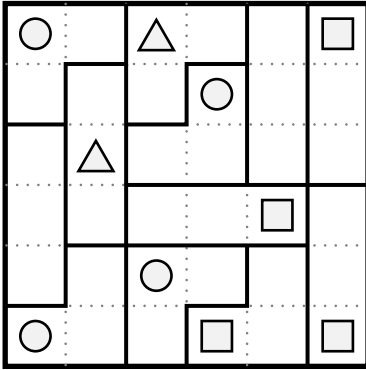

2

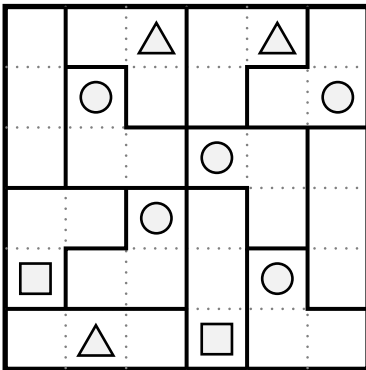

3

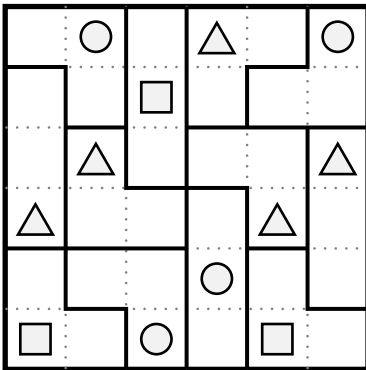

4

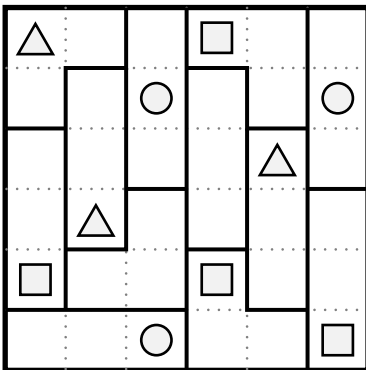

5

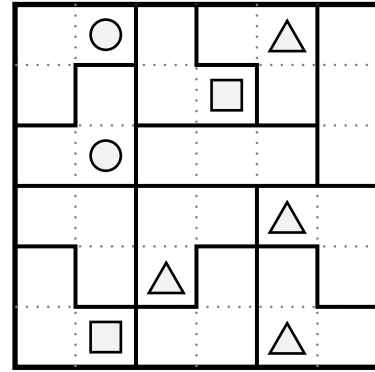

6

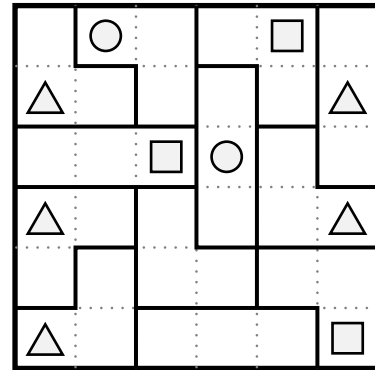

7

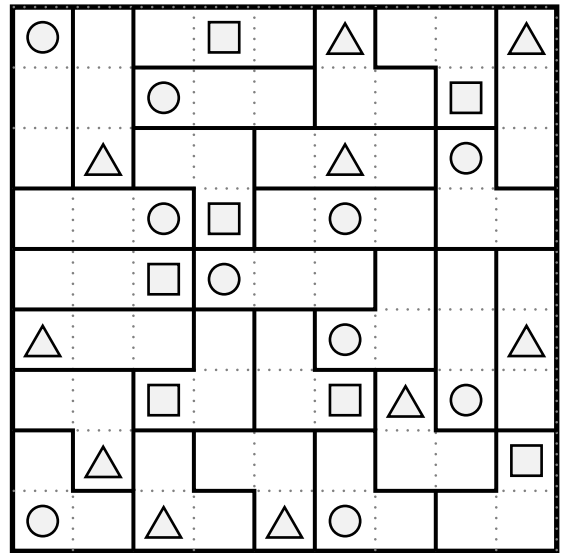

8

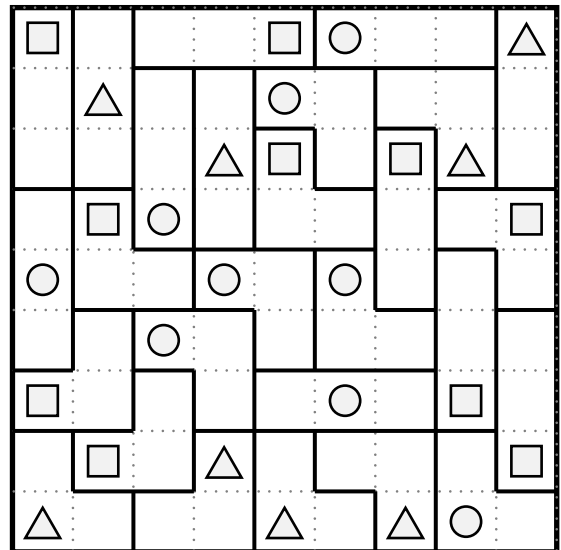

Niveau 2

9

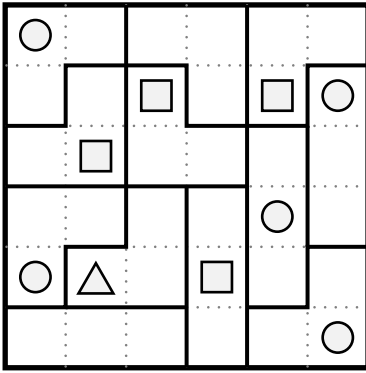

10

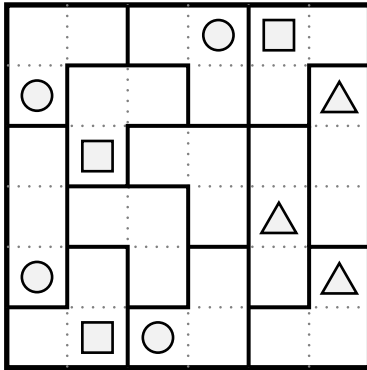

11

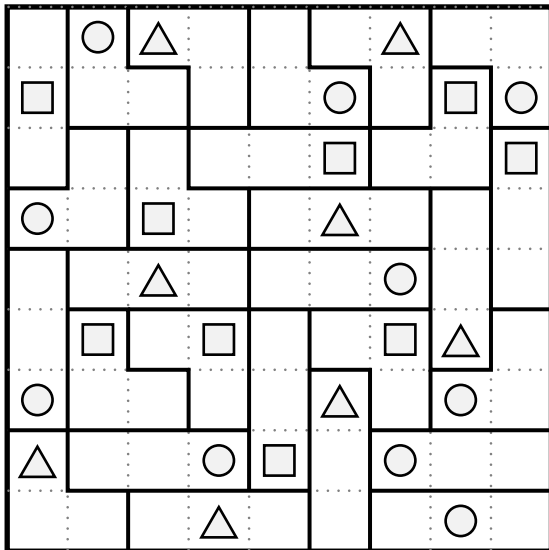

12

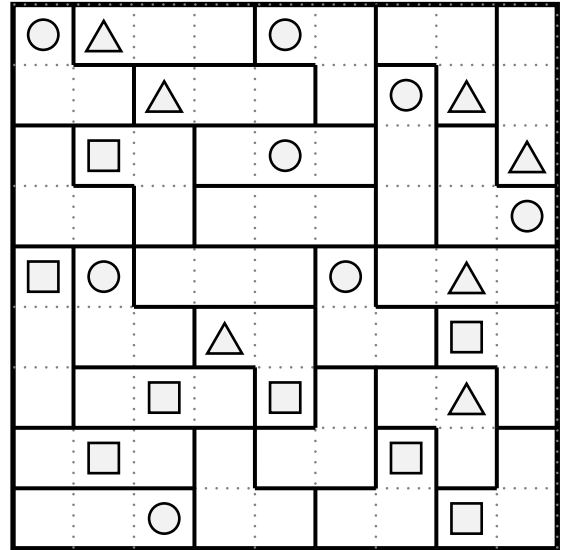

13

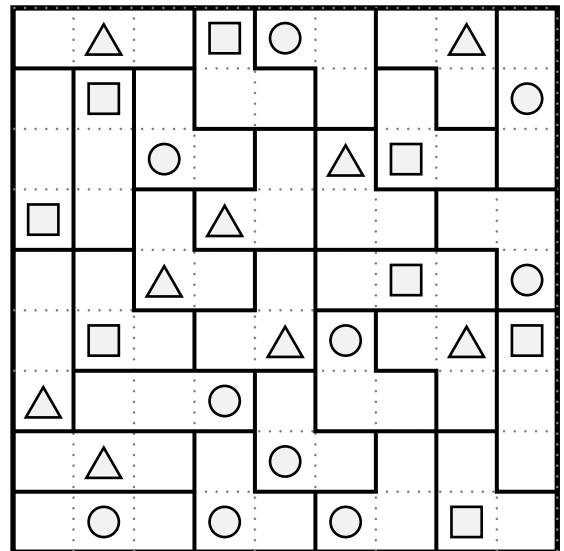

14

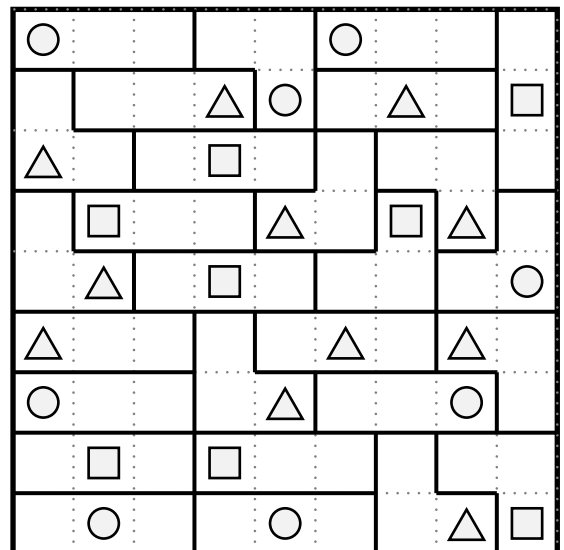

# Voisins — Neighbours

## Niveau 1

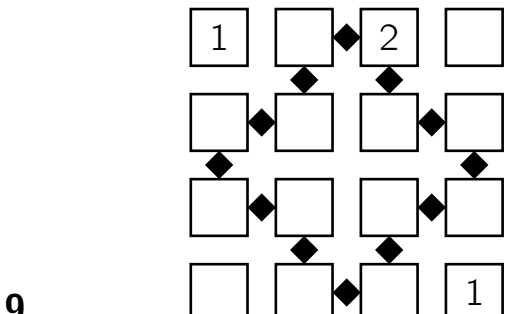
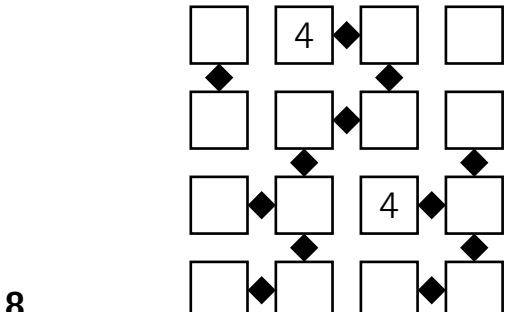
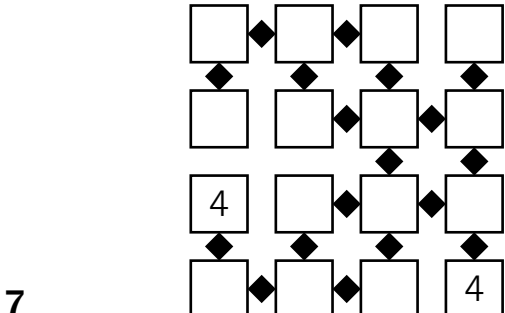
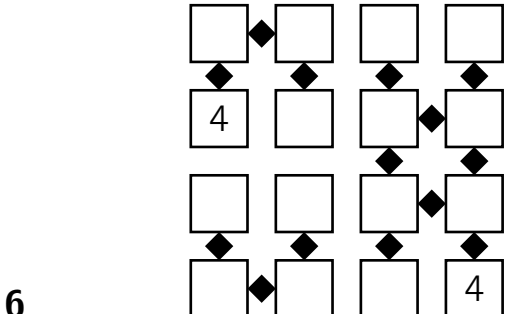
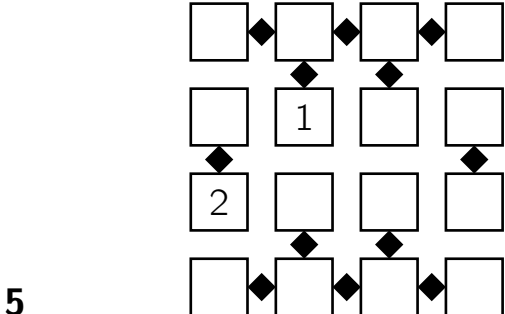
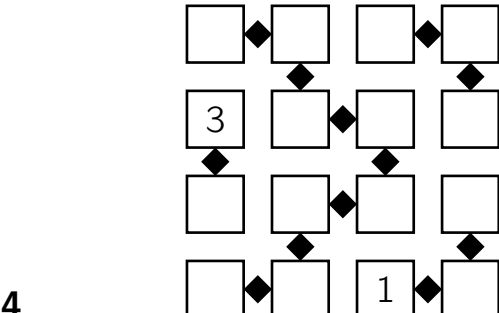
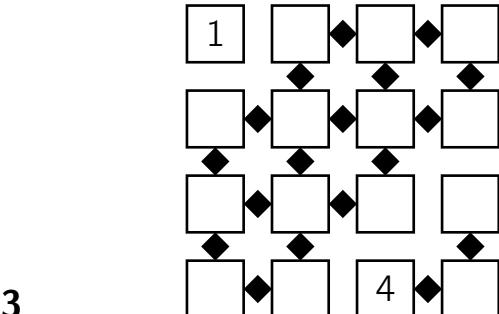
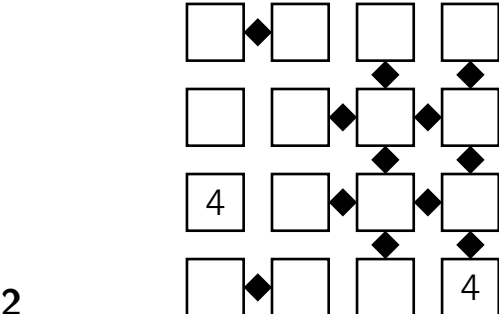
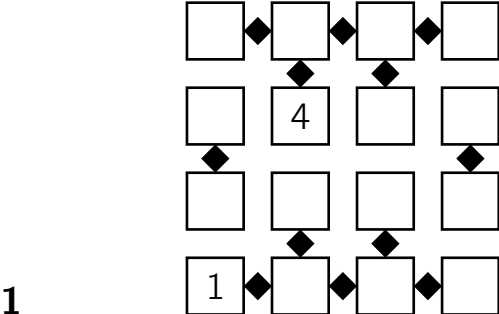



10

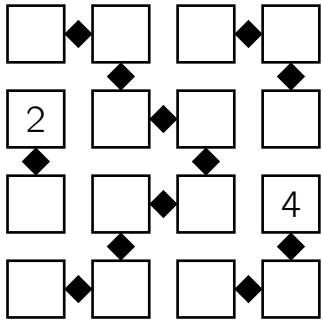

Niveau 2

14

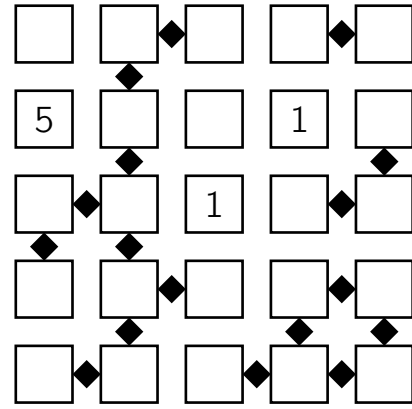

Niveau 3

11

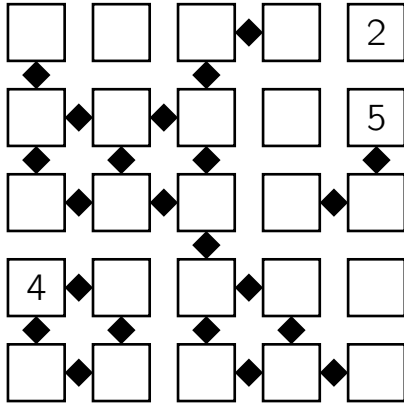

15

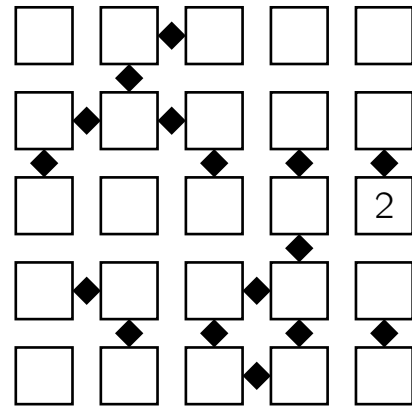

12

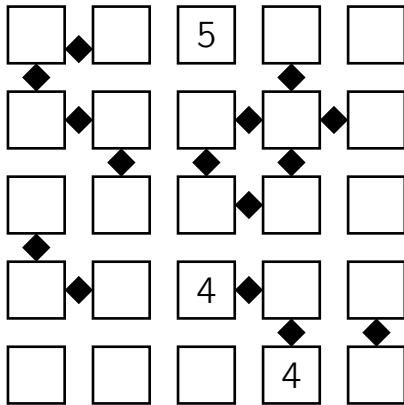

16

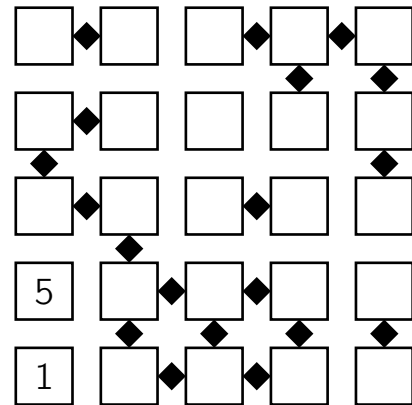

13

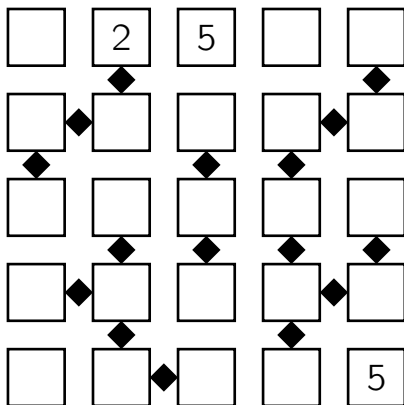

# Walls

## Niveau 1

1

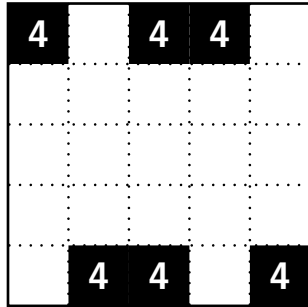

2

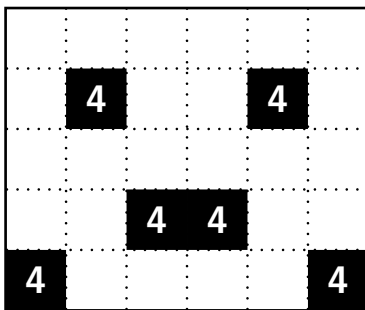

## Niveau 2

3

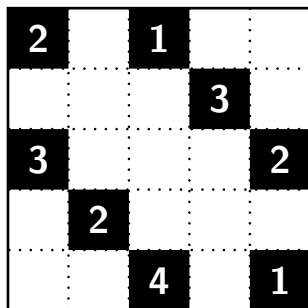

4

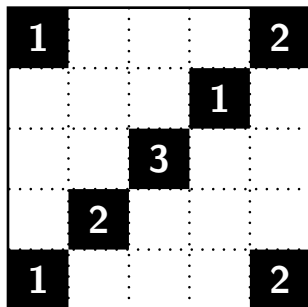

5

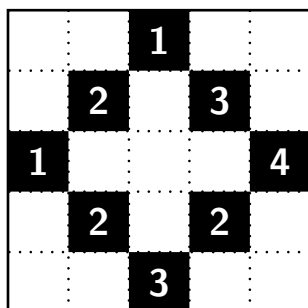

6

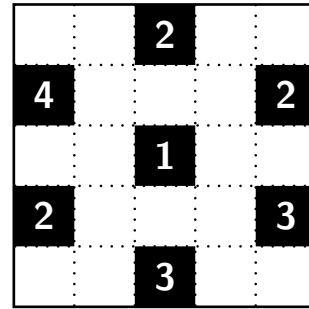

7

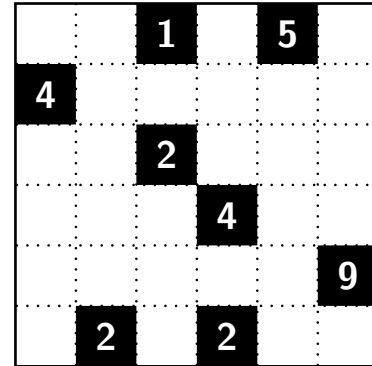

8

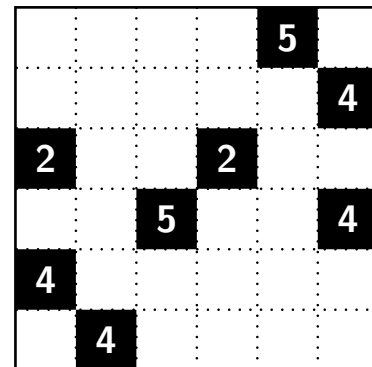

9

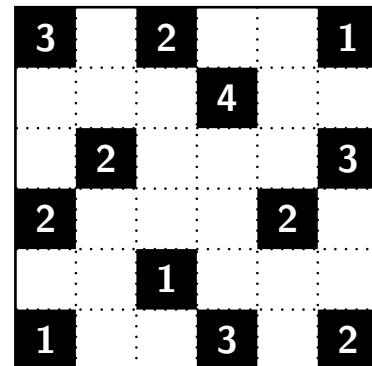

10

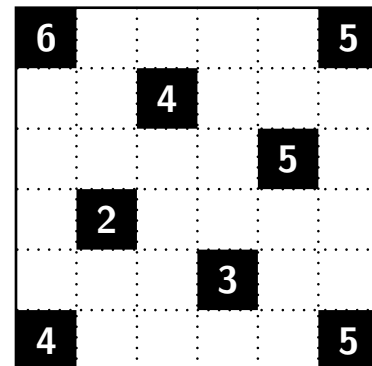

Niveau 3

11

	1			3	
4		2		4	2
	3			1	
		1			
	4			2	
3		1		3	1
	2			4	

14

2			2		
	2			3	
		2			1
2			3		
	3			1	
		2			3

12

11						3
		5		4		
	5		3	4		9
			1	1		
7		5		4		2

15

	2	1			
2				3	1
			2		
		4			
1	2				1
			1	1	

16

	2			3	
3			1		2
				1	
	2				
2		3			1
	2			3	

13

	5		2			
				2		3 2
		6				
5				4		
		7				6
				1		
3	5		3			
				4		4

17

3						3
		2		3		
		2		3		
			2			
	3				4	
		3	2	1		
4						3

# Yakuso

## Niveau 1

1

		0	0
0	3		
		0	

3 5

2

		0	
	0	0	
0	0		

5 6

3

0				0
0	0		0	0
				0

1

4

0	0		0	0
		0		
0				0

6 6

## Niveau 2

5

				0
0				
	0			
0				0

5 8 4 6

6

0				
		0		0
	0			

4 9 10 3

7

			1		
				3	
	0		4	0	
5	5				

4 12 10 9

8

	5		5	5	
	2				
			3		
				1	
4					4

11 2 13 9

9

					0
5		5	5		
	4		4		4
		2			
				0	

12 10 11 7

10

			1		
				3	
	0		4	0	
5	5				

4 12 10 9

	0	0		0	0
0			0	0	0
0	0				0
0					
					0

11

6 7 14 12

		0			
			0		
	0	0	0	0	
0					

15

14 13 5 9 7

				3	
		4	4	4	
					2
5	5				5

12

9 10 5 10

Niveau 4

					0
0				0	
	0	3	0		0
0		0			

16

9 6 8 11 9

Niveau 3

	0				
		2			
0		0			
		0			
			4	4	

13

8 7 9 15

	0				
0				3	
0					0
		0			

17

9 8 12 5 10

0					0
0		0			0
			0		2
					0

14

11 13 7 9 7

	0				
				4	
					0
		0			

18

14 11 12 9 8

# Zehnergitter

## Niveau 1

**1**

4				8		6		1	
0	9			5	7		4	2	6
		0	9		6		7		4
	4	8	5			2			7
0	2	9	7	4	8	3	1	5	
21	19	30	29	22	24	19	27	11	23

**2**

4					9	3		7	6
5				2				3	9
7	8	0	9	6	3		4		
	6	7	3		2	5	8		4
	1	9	6	4		0	2	5	
33	18	30	22	17	24	17	15	18	31

**3**

9	1	5	0		6	4			8
	0		1	5	2	7	8	4	
3		8		0	4		9	5	1
							4	6	
2	4	5	6	9		3			0
25	8	27	16	24	20	28	31	25	21

**4**

0	8		5	4	3		7	9	2
3			9	1	8	4			5
	1	8					5		
	0	3				9		7	5
9		4	0	3	1	7	5	8	
25	22	16	22	14	26	26	25	33	16

**5**

	7	0		1	6	5		8	3
8	5	2	9			3	6	1	0
	7			6				9	3
9		4	7		1	3	8		
6			9	4	5		7		
29	29	8	34	18	24	11	32	25	15

**6**

2	0		9			1	3		4
1					4		0	6	3
	6	2	9	3	7	8			
5		4	6	2				8	1
	8	5		0	7	2	9	6	
15	23	24	32	16	35	16	20	32	12

**7**

	5		8	3	6	0		9	2
4		2			9		3	8	6
5		4	3	8					2
6	2			7		5	9		
	5	3	2			8	0	7	
26	21	10	19	25	25	21	16	35	27

**8**

7			9	2		6		4	1
	2	5		6			9		
0	7	3	8			6			4
			1	7	8		9	5	
1	4	8			0	7	2	6	9
15	19	19	23	23	32	24	27	19	24

## Niveau 2

	4		2		9	3	8	7	5	
5		1	7	0	8	6	9	3	4	
4		5		3	7					
2	6	4	8	5			7			
	3					5		8	6	
<b>9</b>	12	23	12	20	18	40	17	34	24	25

6	1	7		5	4	0	9	3		
7	3	6	9	8		5	4	0	1	
			3						6	
					7	1				
5	7	0	9	8	3		6	1	4	
<b>10</b>	23	25	19	28	24	20	16	30	21	19

2	8	0	3	4		7	5		1	
	3		1					6	4	
0		5	6	3	4	1	2	9	8	
					0	3	7			
7	5	9		2	4			3		
<b>11</b>	27	24	18	24	21	19	19	22	33	18

	8		2	9						
3	9	6					0	1	4	
6		0	9	3	1	4				
4	8		5	2	9	3	6	0	1	
		4			5	2	1	7	8	
<b>12</b>	21	39	21	21	27	17	18	15	23	23

## Niveau 3

5	2			1			3			
	7		0	8	9			6		
	0	5					9		4	
5			6		8	3		1	7	
		5			6	0	7		4	
<b>13</b>	27	19	23	25	14	28	17	27	25	20

6		8	7	2	3	4	0		9	
	7		5				2			
		2		7			9		5	
8			0		9	7			4	
	1	7		6	0	8		9		
<b>14</b>	23	18	23	21	23	24	28	21	23	21

	1			7	3		5	0	4	
0			1	4			3	6		
4	1						2			
	8	6	3		7					
6		7			9	4		3	5	
<b>15</b>	18	18	24	25	25	27	29	16	25	18

5	7				2	8	0	3		
		1		9			2	6	0	
2	6			3	8	9				
4								9	3	
	1				3		6			
<b>16</b>	22	17	21	19	16	26	36	23	27	18

# Zipline

## Niveau 1

1

<b>1</b>	<b>5</b>	
		<b>9</b>

2

<b>1</b>		
<b>5</b>	<b>6</b>	

## Niveau 2

3

	<b>12</b>	
<b>11</b>		
		<b>5</b>

4

<b>5</b>		
<b>0</b>	<b>6</b>	

5

<b>6</b>		<b>5</b>
<b>9</b>		

6

<b>8</b>			<b>8</b>
<b>3</b>	<b>17</b>		
<b>10</b>		<b>18</b>	

7

	<b>18</b>	<b>12</b>	
<b>27</b>			
<b>9</b>	<b>4</b>	<b>4</b>	

8

	<b>10</b>		<b>4</b>
	<b>13</b>		<b>5</b>
		<b>14</b>	
	<b>19</b>		

9

<b>8</b>	<b>5</b>	<b>5</b>	
	<b>13</b>	<b>4</b>	
		<b>16</b>	

10

	<b>12</b>			<b>5</b>
<b>7</b>		<b>10</b>		

11

<b>6</b>		<b>11</b>	
<b>9</b>		<b>6</b>	

## Niveau 3

12

		<b>10</b>	
	<b>18</b>		<b>9</b>
<b>11</b>			
<b>8</b>		<b>24</b>	

13

	<b>19</b>		<b>9</b>
	<b>17</b>		<b>13</b>
	<b>15</b>		<b>5</b>

14

	<b>19</b>		
<b>18</b>			<b>9</b>
			<b>8</b>
<b>8</b>	<b>11</b>		



15

		6	
	19		
15			24
0	14		

16

	7		
		19	
15	14		18
	18		

17

	17		
18			13
			10
14		20	

18

	17		
16			13
			10
14		20	

19

10			8
		17	
10		8	8

20

	26			4
13		18		4

21

			7
		19	
	15		9

Niveau 4

22

	5	12	
			12
		22	5
13			

23

13			13
	26		
17		26	
	16		

24

13				
		14	15	
	15			12

Niveau 5

25

10			
	21		
13		19	
	12		8

26

				19
6	14	11	34	
10		26		
			29	
15				

27

13			6	6
	24	9		
	50		46	
29				29

# Zwischenknick

## Niveau 1

1

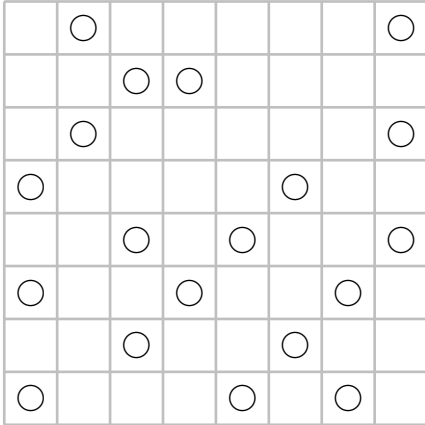

## Niveau 2

2

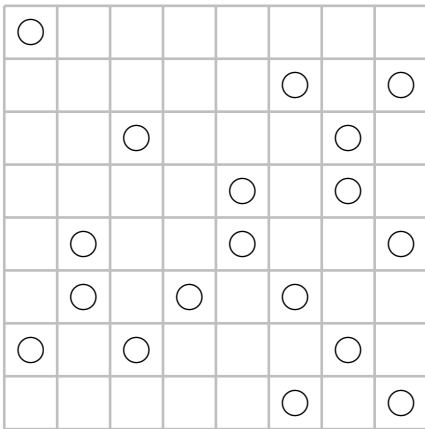

3

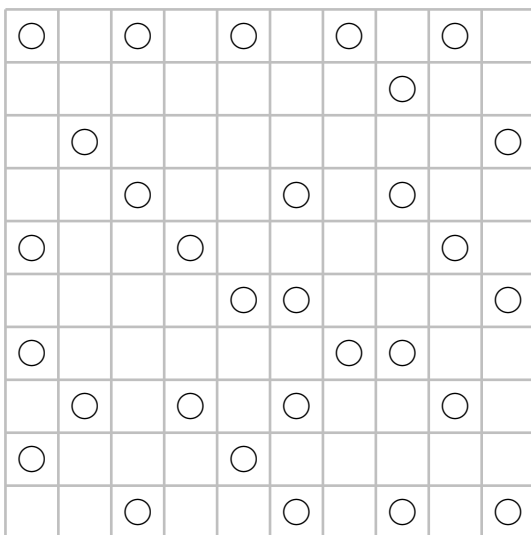

4

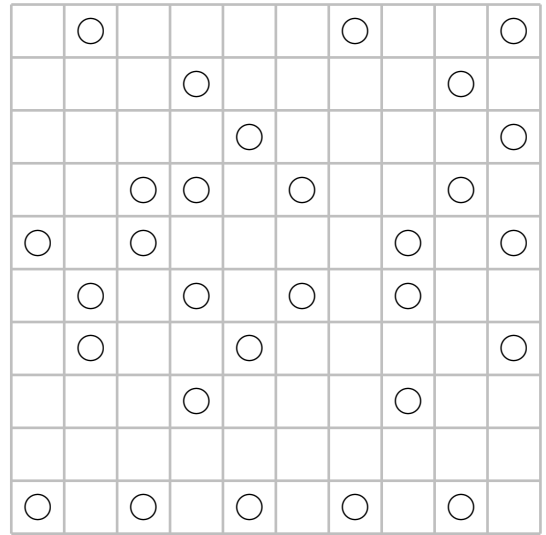

5

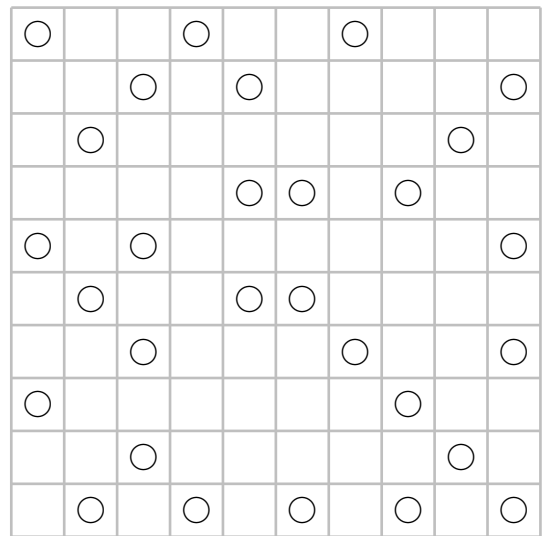

6

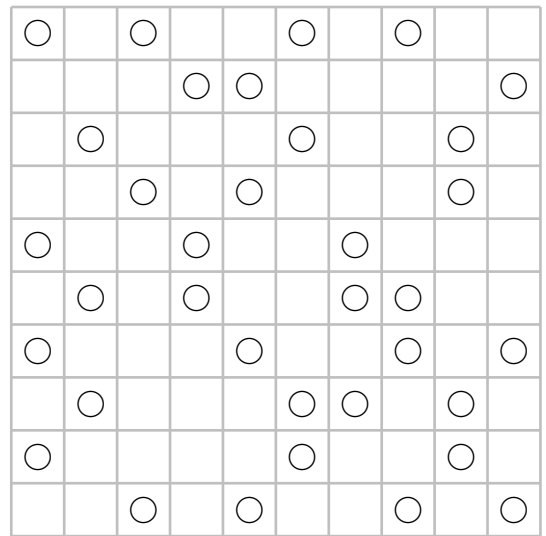

### Niveau 3

7

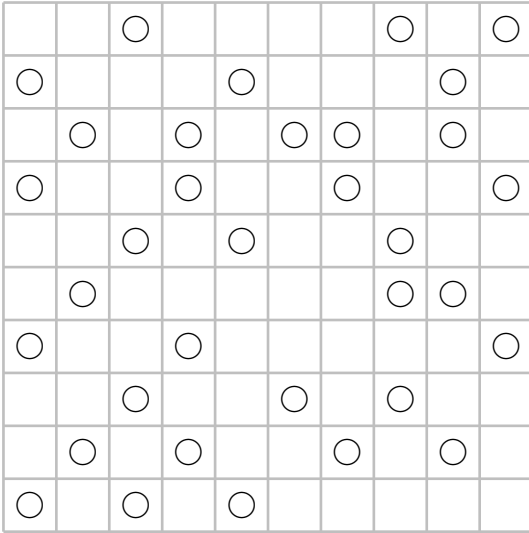

8

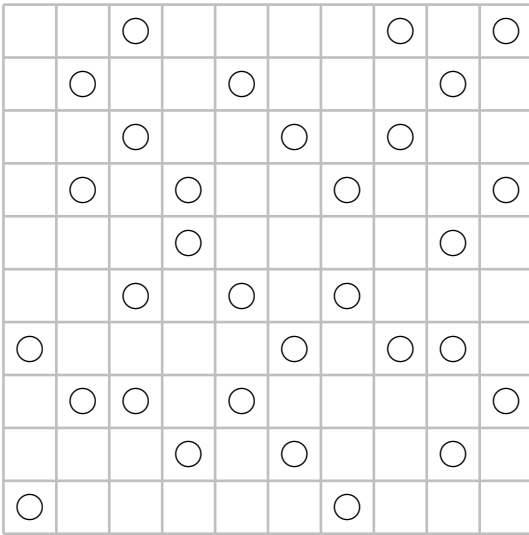

9

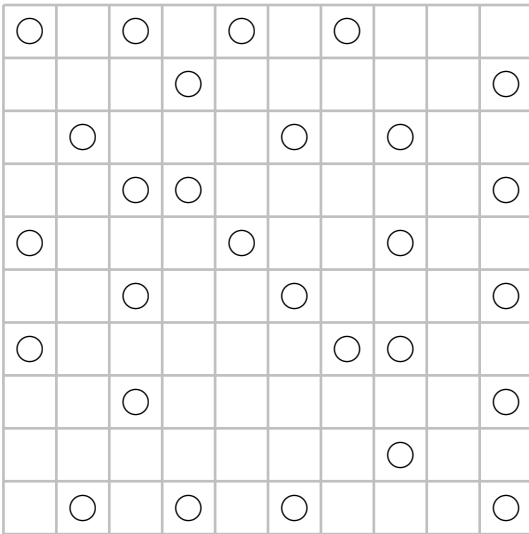

10

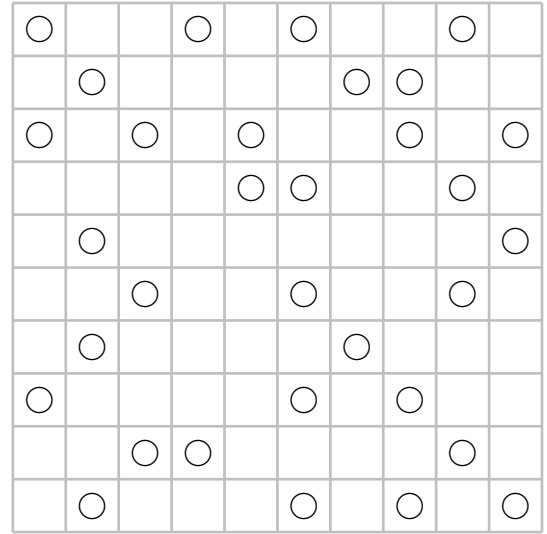

11

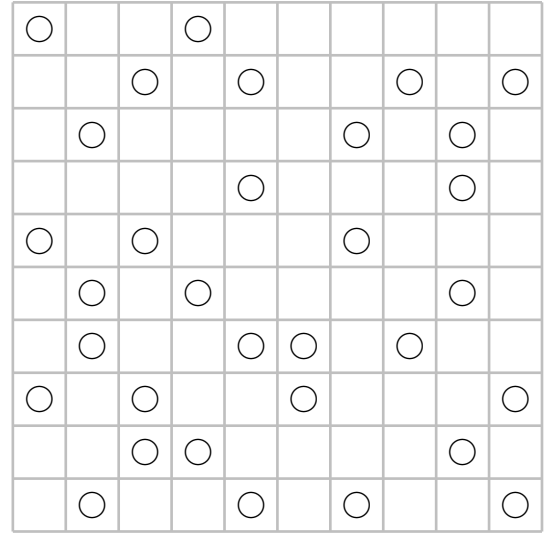

12

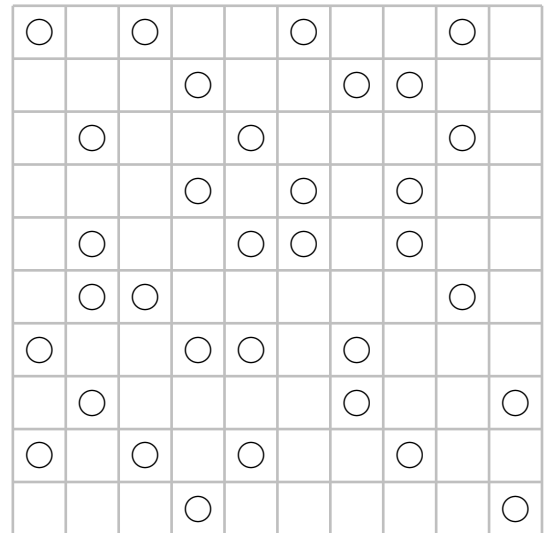

1

	A	B	
	B		A
A		A	B

B

2

A	A	B	
	B		A
		A	B

B

3

			A
A	A	B	
	B		A
		A	B

4

	A			B
	C			
A	C	B	A	
		A	B	C
B			C	A

C

5

			B	
	C		A	
C	A	B		
	B	C	A	

C

6

		B	C	A
A			B	C
C	A			B
B	C	A		

C      B

7

				B
B	A	B	C	
	B	C		A
		A	B	C
C			A	B

8

	A	A		
C	A		B	C
	B	A	C	
		C	A	B
C	C	B		A

9

				A
B		C	A	
C	A			B
	B	A	C	
A	C	B		

A      B

10

				B
C		A	B	C
	C		A	B
B	C			A
A	B	C		

A      A

11

C	C	B			A
			A	C	B
B				A	C
	A	C	B		
A	C	B			

B      B

	C		A		B	
A	A	C	B			
C			C	B	A	
	B			A	C	C
	B	A		C		
						C C C

12

		A	B			
		B	C	D	A	
A	A		D	B	C	C
	D	C		A	B	
	C	A	B		D	D
	B	D	A	C		C
						D

16

	D		C	A	B	B
A		A	D	B	C	C
	C	D	B		A	
	B	C	A	D		D
A	A	B		C	D	
						A

13

			B			
		C	B	D	A	
A	A	D	C		B	
D	D	B	A	C		C
C	C	A		B	D	D
	B		D	A	C	
						A A

17

		A		C	B	
		D	A	C	B	B
A	A	C	B		D	
	B		D	A	C	
D	D	A	C	B		B
C	C	B		D	A	
						C D

14

			B		C	
A	A	B		C	D	
	C	D	B		A	
	B	C	A	D		D
D	D		C	A	B	
A		A	D	B	C	
						D B

18

		B	C	C	A	
		C		A	B	
B	B	A	C			C
	A		B		C	C
	C		A	B		B
		B		C	A	
						A

15

**1**

	<b>A</b>	1	2	1	1	
	<b>B</b>	1	1	2	1	
<b>A</b>	<b>B</b>	<b>C</b>	2	1	1	2
1	2	1	B	A	B	C
1	2	1	C	B	A	B
1	1	2	A	C	B	C
2	0	2	C	A	C	A

**5**

	<b>A</b>	1	1	2	1	
	<b>B</b>	1	2	2	2	
<b>A</b>	<b>B</b>	<b>C</b>	2	1	0	1
1	2	1	C	B	A	B
1	1	2	A	C	B	C
1	2	1	C	B	A	B
2	2	0	B	A	B	A

**2**

	<b>A</b>	2	2	2	2	
	<b>B</b>	1	0	2	0	
<b>A</b>	<b>B</b>	<b>C</b>	1	2	0	2
2	0	2	A	C	A	C
2	1	1	C	A	B	A
2	0	2	A	C	A	C
2	2	0	B	A	B	A

**6**

	<b>A</b>	2	1	2	0	
	<b>B</b>	1	1	1	2	
<b>A</b>	<b>B</b>	<b>C</b>	1	2	1	2
2	0	2	A	C	A	C
1	2	1	B	A	C	B
1	1	2	A	C	B	C
1	2	1	C	B	A	B

**3**

	<b>A</b>	1	2	2	0	
	<b>B</b>	1	2	0	2	
<b>A</b>	<b>B</b>	<b>C</b>	2	0	2	2
1	1	2	C	A	C	B
2	1	1	A	B	A	C
1	2	1	B	A	C	B
1	1	2	C	B	A	C

**7**

	<b>A</b>	0	1	1	1	
	<b>B</b>	2	1	2	2	
<b>A</b>	<b>B</b>	<b>C</b>	2	2	1	1
1	2	1	C	B	A	B
1	2	1	B	C	B	A
1	1	2	C	A	C	B
0	2	2	B	C	B	C

**4**

	<b>A</b>	2	1	2	1	
	<b>B</b>	1	1	0	1	
<b>A</b>	<b>B</b>	<b>C</b>	1	2	2	2
2	0	2	A	C	A	C
0	2	2	C	B	C	B
2	0	2	A	C	A	C
2	1	1	B	A	C	A

**A** 2 1 1 2  
**B** 0 1 2 0  
**C** 2 1 0 1  
**A B C D** 0 1 1 1  
 2 1 1 0 

C	A	B	A
A	B	D	C
C	D	A	D
A	C	B	A

8

**A** 2 1 2 1 1 1  
**B** 0 1 1 1 1 1  
**C** 2 1 1 0 2 1  
**A B C D** 0 1 0 2 0 1  
 3 1 0 2 

A	D	A	D	B	A
C	A	B	A	C	D
A	C	A	B	A	C
C	B	C	D	C	B

11

**A** 1 1 2 1  
**B** 1 1 1 1  
**C** 1 1 0 1  
**A B C D** 1 1 1 1  
 2 2 0 0 

A	B	A	B
C	D	B	C
D	A	D	A
B	C	A	D

9

**A** 0 2 0 1 0 2  
**B** 2 1 1 1 1 0  
**C** 1 0 2 1 2 1  
**A B C D** 1 1 1 1 1 1  
 2 1 2 1 

B	A	C	A	C	D
D	B	D	B	D	A
C	D	B	C	B	C
B	A	C	D	C	A

12

**A** 1 2 1 0 1 2  
**B** 1 1 0 1 1 1  
**C** 1 0 1 2 0 0  
**A B C D** 1 1 2 1 2 1  
 2 1 1 2 

B	A	D	C	D	A
A	B	A	B	A	B
D	A	D	C	D	A
C	D	C	D	B	D

10

**A** 1 1 1 2 1  
**B** 1 2 2 1 1  
**C** 2 0 2 1 1  
**A B C D** 1 2 0 1 2  
 0 1 2 2 

C	D	B	C	D
D	B	C	A	B
A	D	A	D	A
B	A	B	A	C
C	B	C	B	D

13

W	B	C	U	T	L	D
H	G	H	X	Y	K	K
I	F	W	I	J	L	F
M	E	V	U	N	M	N
R	B	D	O	T	R	O
Q	A	C	P	Q	S	P
J	E	V	X	Y	S	G

1

H	R	W	E	I	K	O
C	U	W	X	Y	C	Y
D	V	T	E	D	B	V
F	S	F	H	I	A	S
L	R	O	G	J	L	G
Q	P	Q	N	M	K	N
P	U	T	X	M	B	J

5

F	D	B	V	O	P	H
R	F	E	R	O	P	E
N	D	G	S	Q	N	Q
C	C	B	H	T	M	T
L	Y	A	I	U	L	I
K	X	W	V	J	K	J
X	Y	W	S	U	M	G

2

C	F	H	T	B	L	K
J	G	H	J	M	L	M
N	F	D	I	K	N	I
E	E	U	C	B	O	U
P	W	V	T	A	P	W
Q	X	Y	S	R	Q	X
V	G	Y	S	R	O	D

6

L	T	U	C	Y	I	N
P	Q	P	O	D	E	Q
R	R	A	C	N	F	F
M	S	B	L	M	G	G
H	T	W	K	J	H	K
V	V	U	X	Y	I	X
W	S	B	O	D	E	J

3

L	J	N	Q	S	W	Y
M	L	M	A	X	Y	X
D	K	N	D	B	W	K
V	J	E	O	C	V	E
F	F	I	P	R	U	R
T	G	H	Q	S	T	H
B	G	I	P	C	U	O

7

P	K	H	O	V	T	B
E	G	H	E	D	C	G
F	I	F	A	B	R	R
Q	K	J	P	Q	S	S
Y	L	Y	O	W	T	L
N	M	N	X	V	U	U
M	I	J	X	D	C	W

4

X	D	C	H	P	J	Y
E	E	F	H	I	J	I
K	D	G	B	L	K	B
M	S	C	Y	A	M	S
N	T	R	Q	X	N	T
W	U	V	W	P	O	V
R	U	F	Q	L	O	G

8



9

H	T	X	D	P	M	B
S	T	S	R	P	A	R
Q	V	U	Q	B	O	O
W	W	G	H	C	N	G
F	F	X	D	I	M	I
L	Y	E	J	K	L	K
Y	V	E	J	C	N	U

13

H	C	R	I	L	V	K
F	G	F	I	Y	X	Y
W	E	H	J	K	W	J
D	D	R	T	L	V	T
Q	C	S	Q	U	M	M
O	A	B	P	O	N	N
S	E	B	P	U	X	G

10

X	G	C	J	L	M	F
U	Y	V	U	T	S	T
P	A	X	W	P	R	W
Q	B	C	D	O	Q	D
H	H	F	E	L	N	N
K	G	I	J	K	M	I
S	B	V	E	O	R	Y

14

E	L	P	H	X	C	S
J	L	K	J	X	Y	K
W	M	I	H	G	W	G
V	N	P	U	V	F	N
O	O	T	Q	E	C	Q
D	S	R	A	B	D	R
Y	M	T	U	B	F	I

11

V	U	N	R	H	D	O
X	X	W	K	H	I	K
L	Y	V	L	J	G	J
F	U	T	M	E	F	T
B	P	N	S	B	D	P
Q	O	Q	R	A	C	C
I	Y	W	S	E	G	M

15

P	D	C	H	X	W	M
E	D	E	Y	X	W	Y
F	B	C	F	V	U	B
G	A	O	P	G	T	T
S	N	K	H	Q	S	K
R	M	L	J	I	R	L
V	N	O	J	I	U	Q

12

C	D	X	Y	J	L	R
I	A	B	I	J	K	B
H	D	C	F	H	L	F
G	W	E	R	G	M	W
V	V	X	S	Q	N	N
T	U	T	Y	O	P	P
K	U	E	S	O	M	Q

16

M	K	I	D	E	Q	P
F	H	G	F	E	P	G
J	J	I	D	O	Q	O
N	K	C	M	N	R	R
S	B	L	X	U	S	U
W	A	W	V	Y	T	V
L	B	C	X	Y	T	H

1

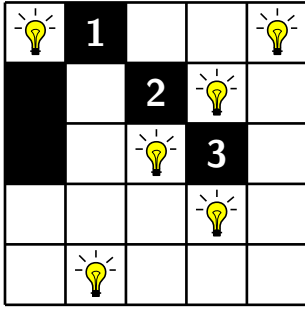

2

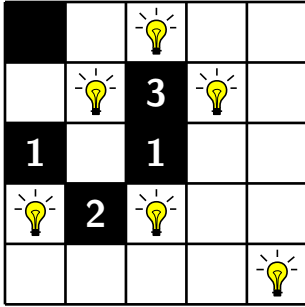

3

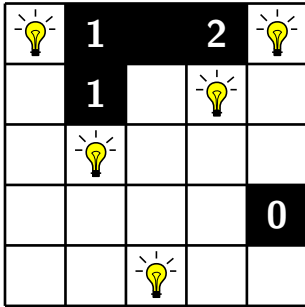

4

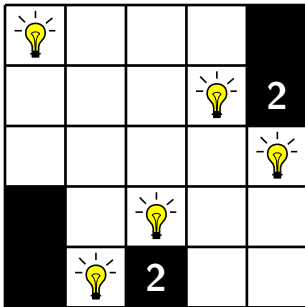

5

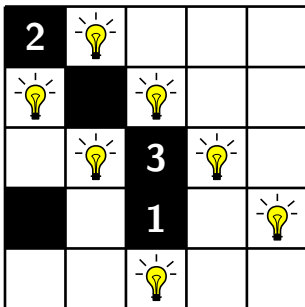

6

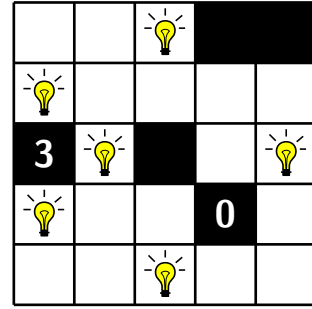

7

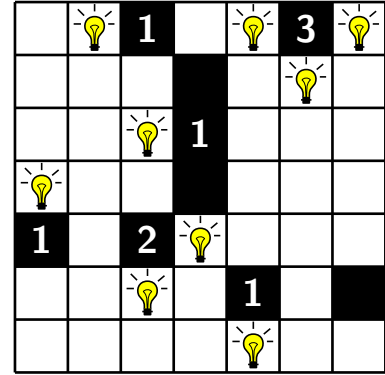

8

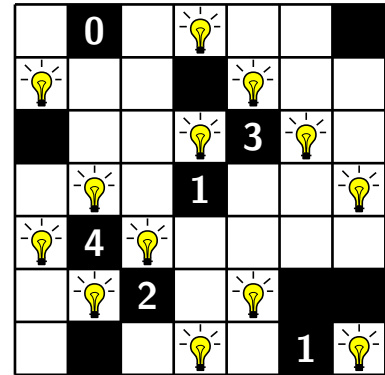

9

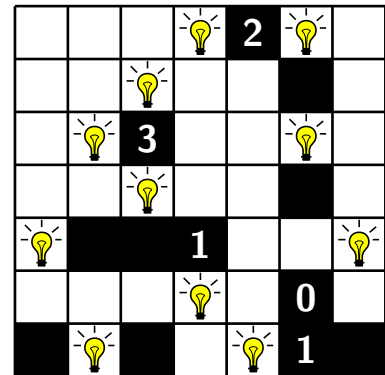

10

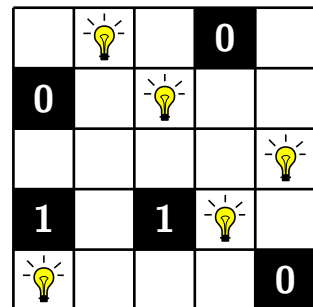

11

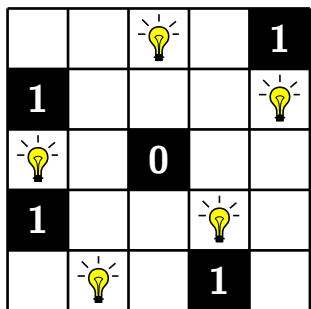

16

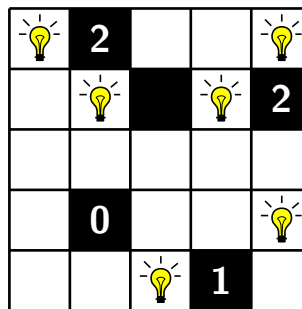

12

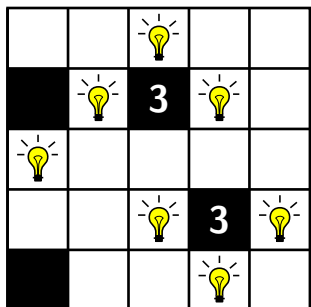

17

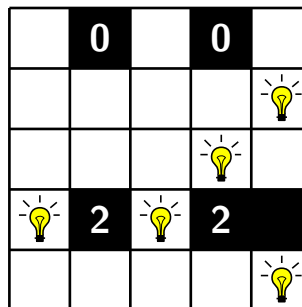

13

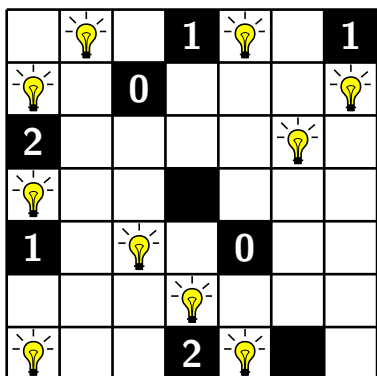

18

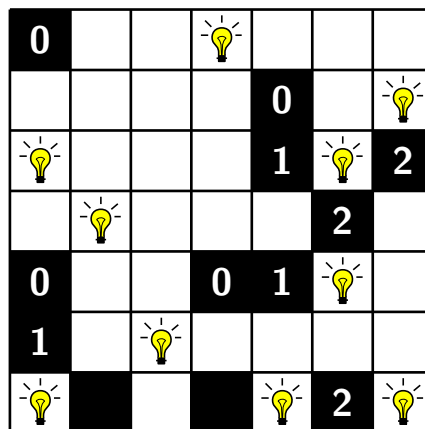

14

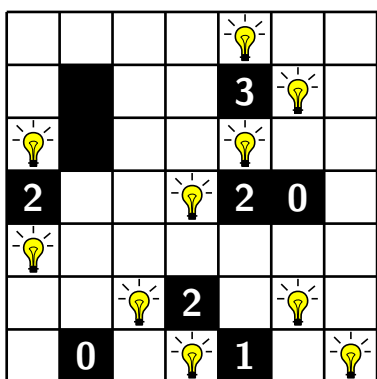

19

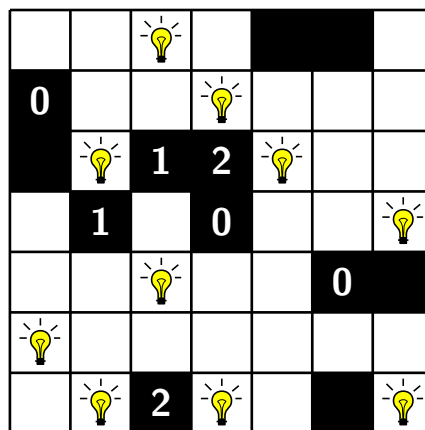

15

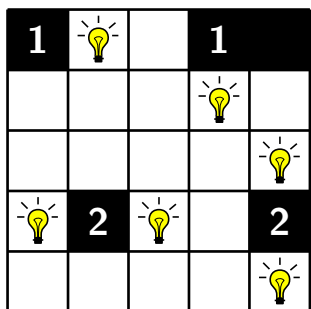

1

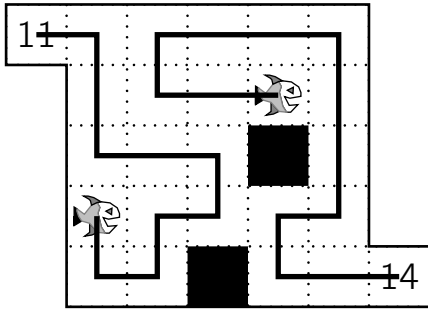

2

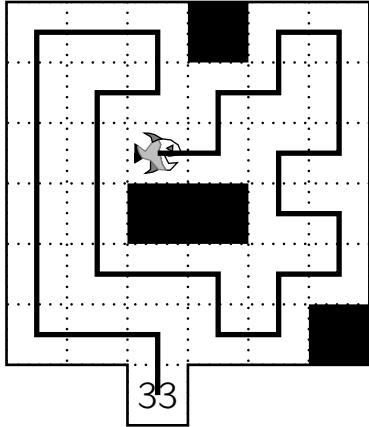

3

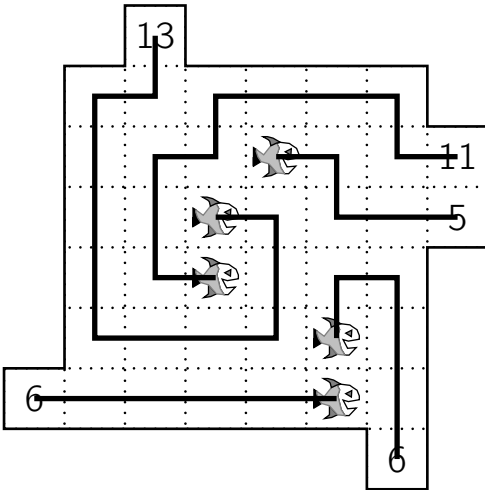

4

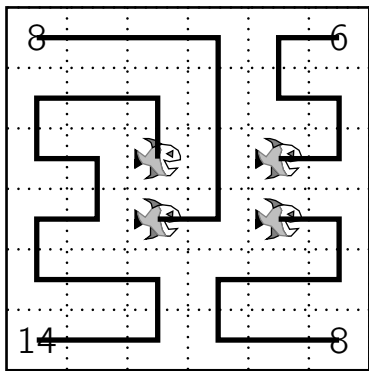

5

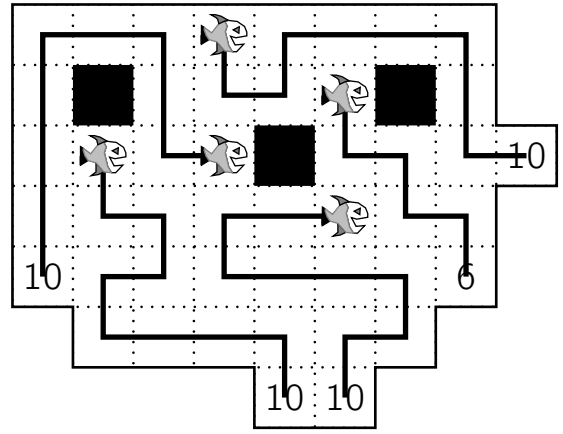

6

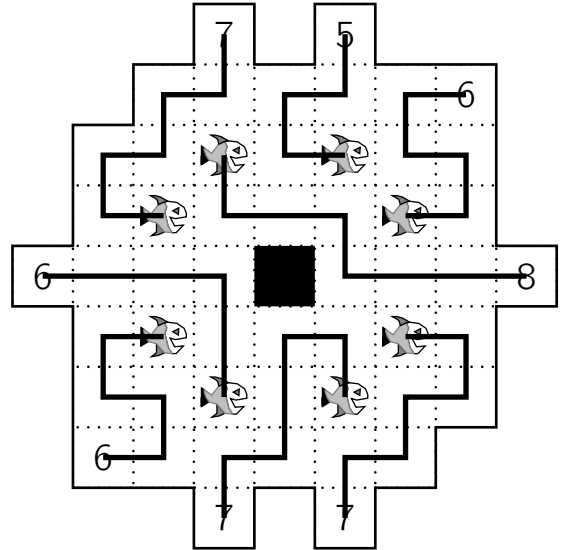

7

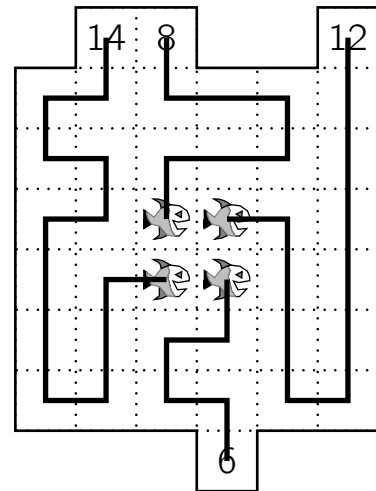

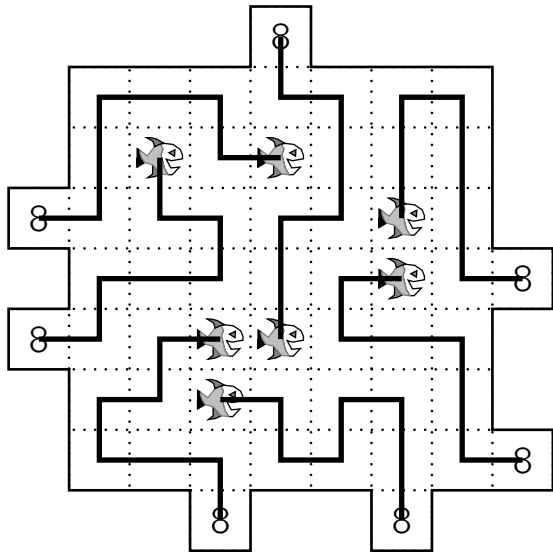

8

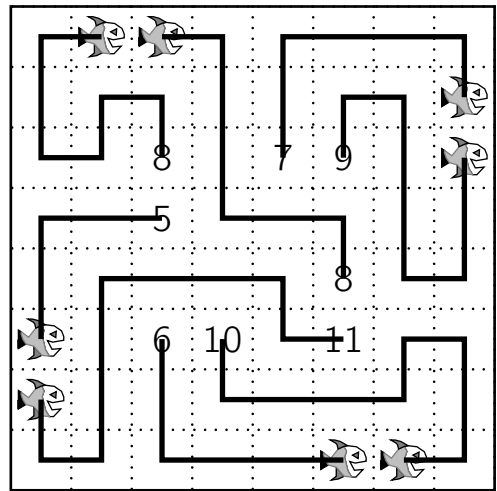

11

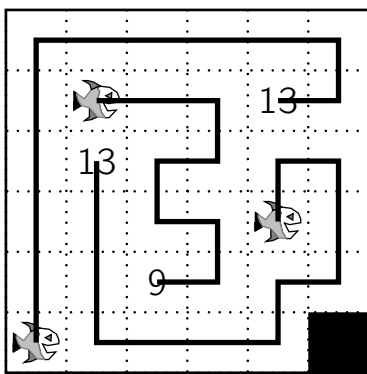

9

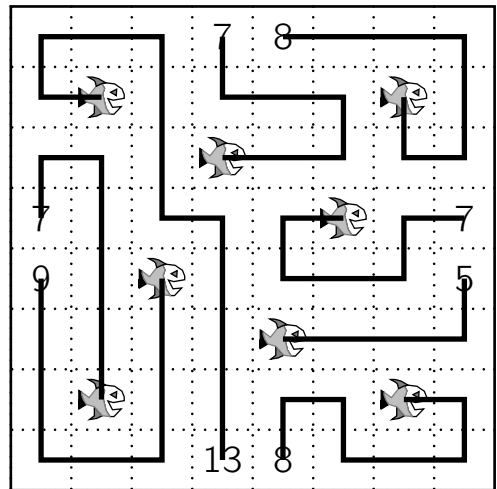

12

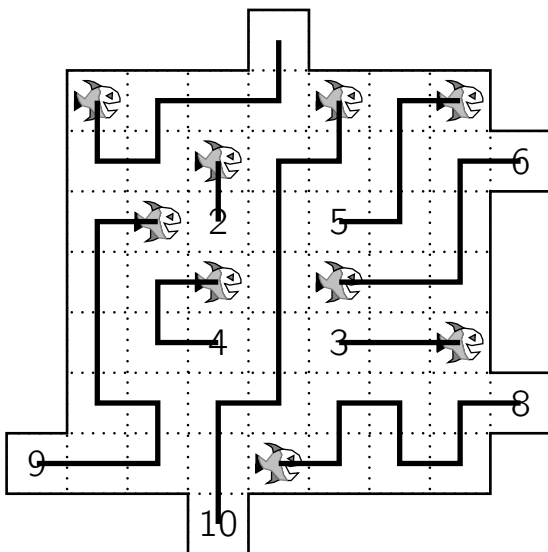

10

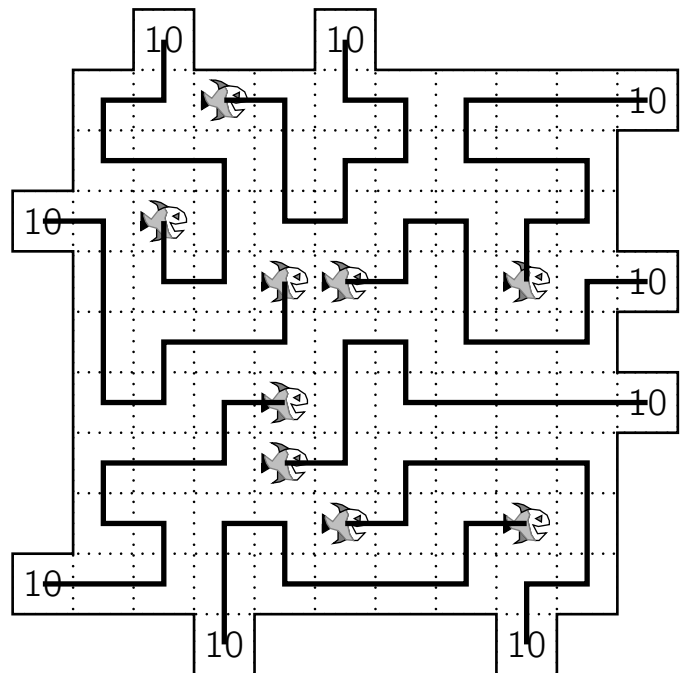

13

1

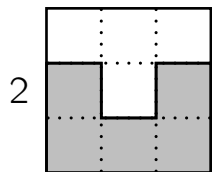

2

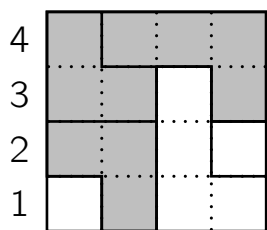

3

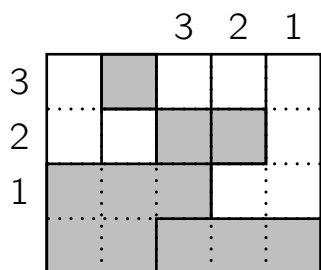

4

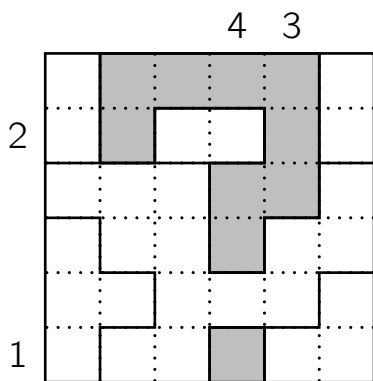

5

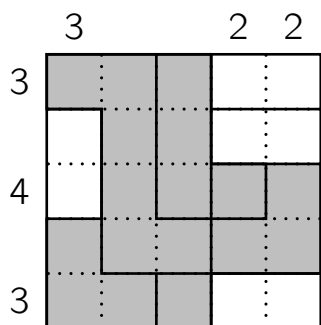

6

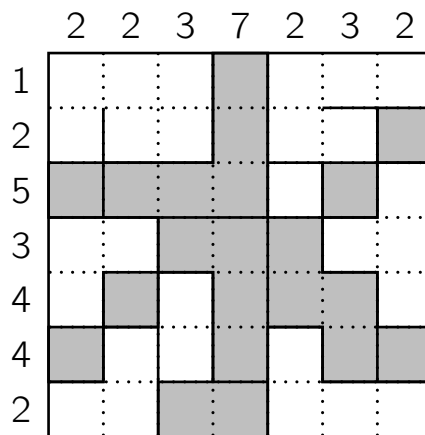

7

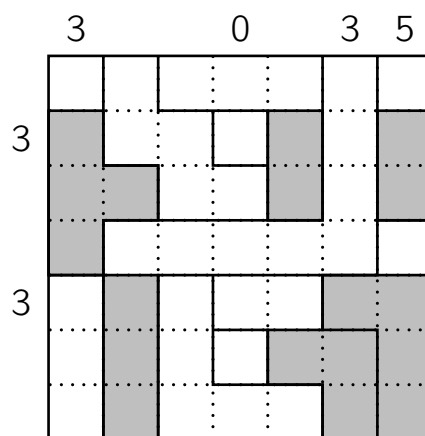

8

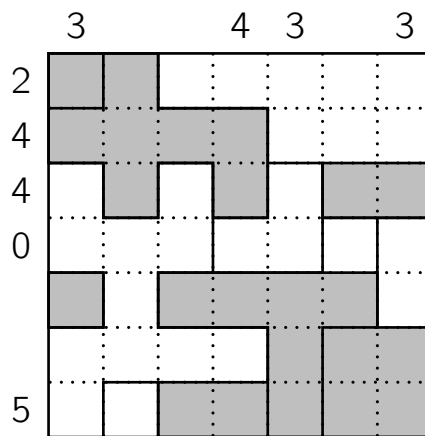

9

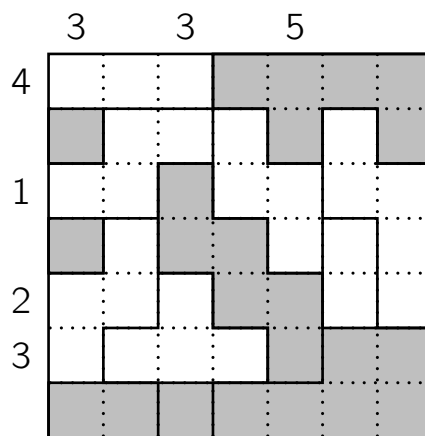

10

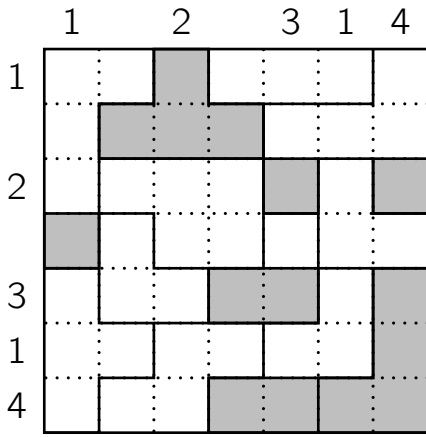

11

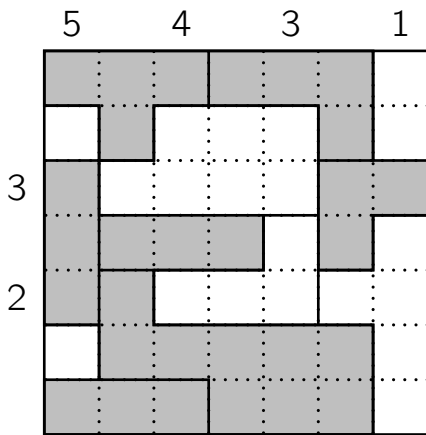

12

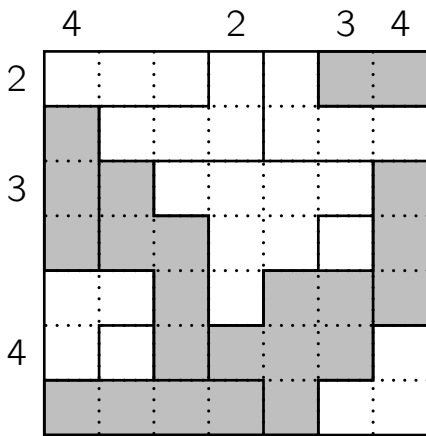

13

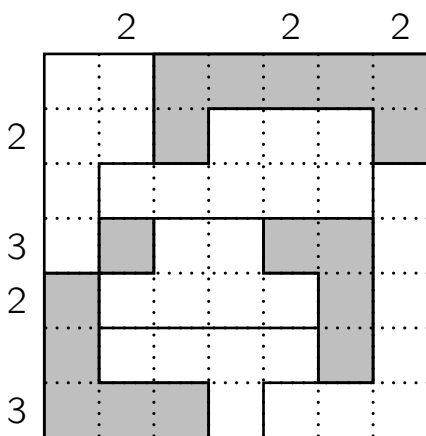

14

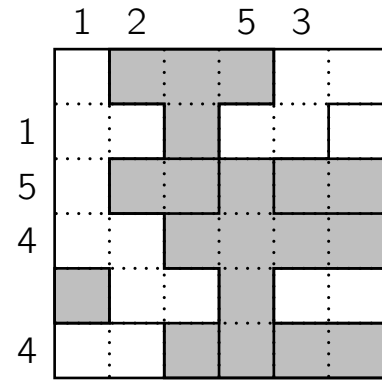

15

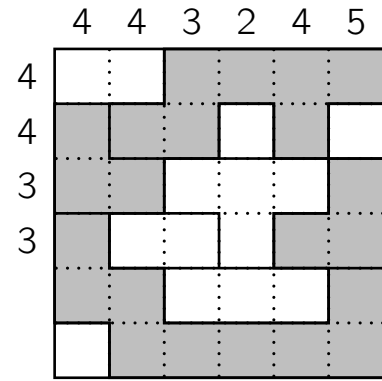

16

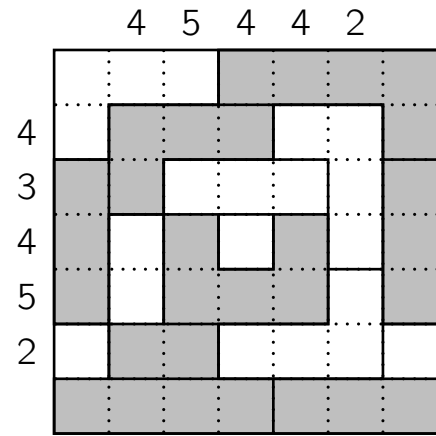

17

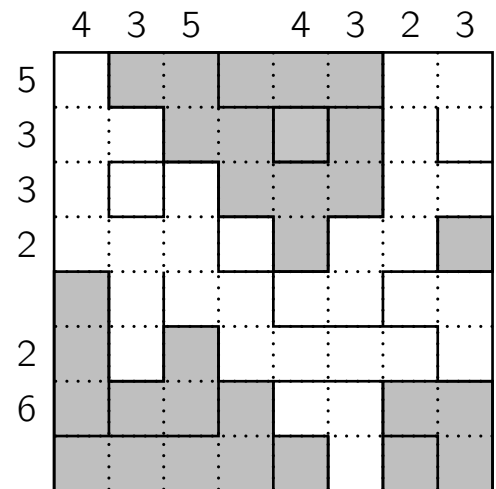





11

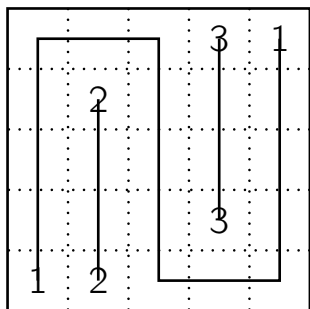

16

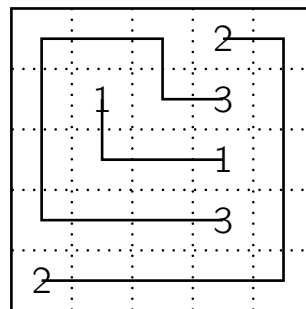

12

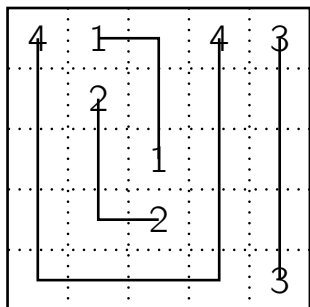

17

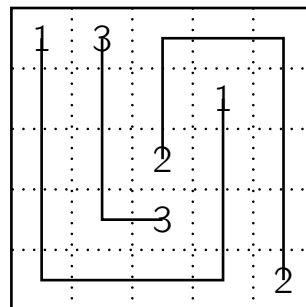

13

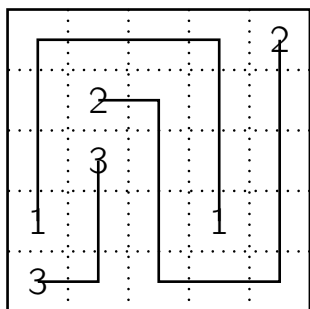

18

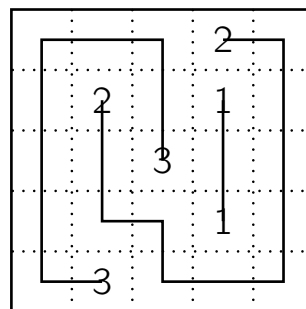

14

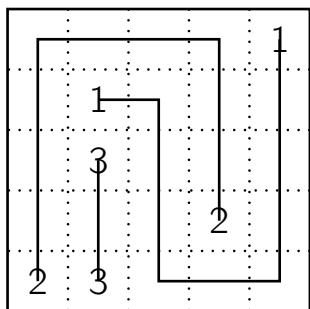

19

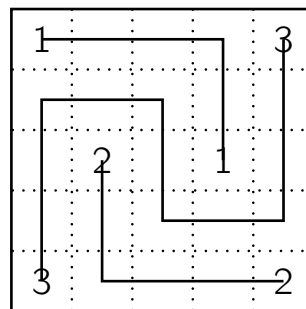

15

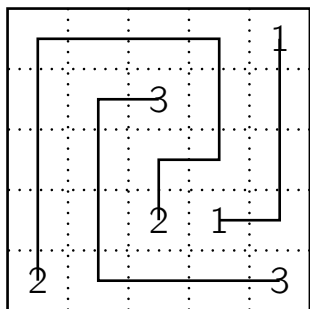

20

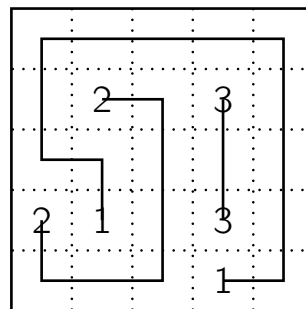

1

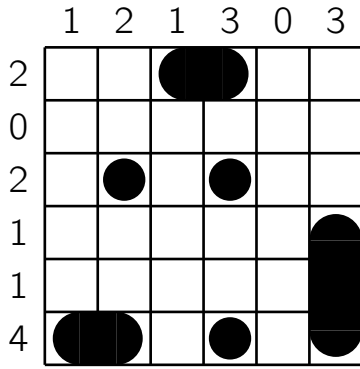

2

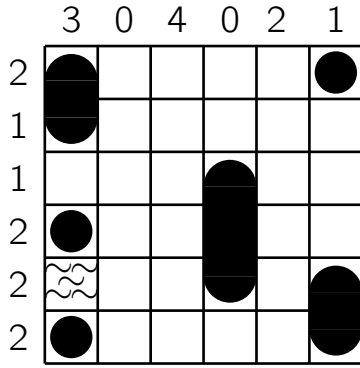

3

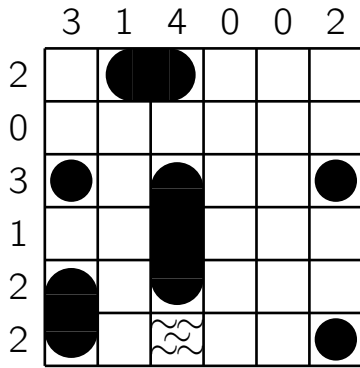

4

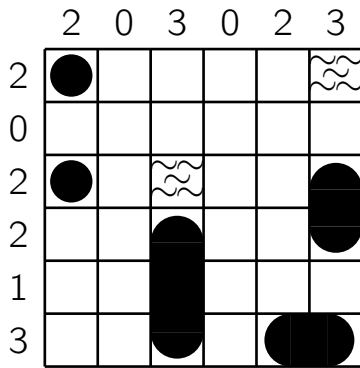

5

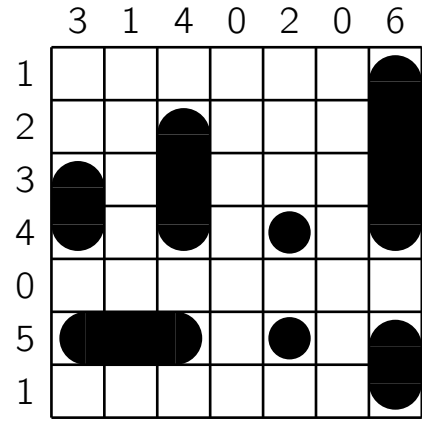

6

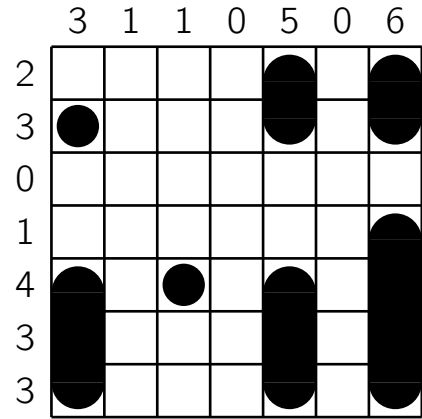

7

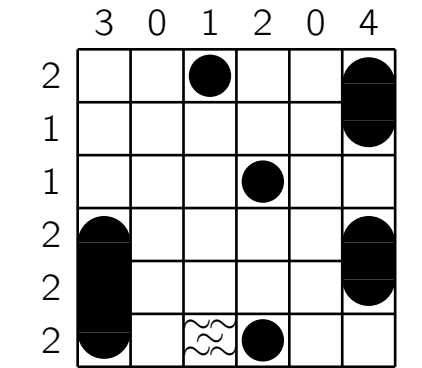

8

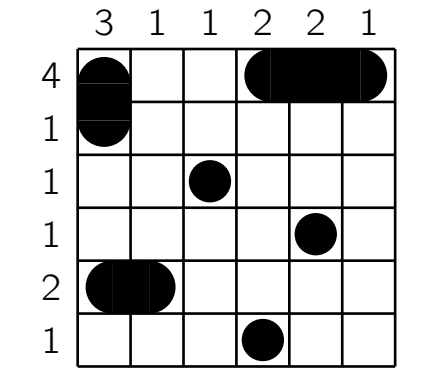

9

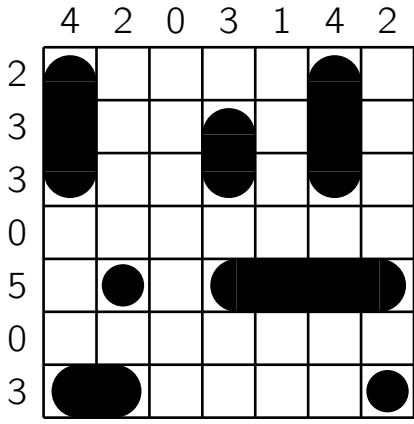

10

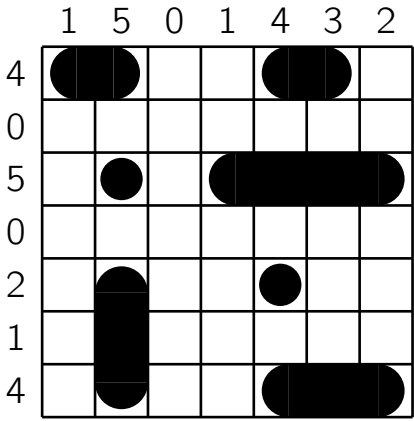

11

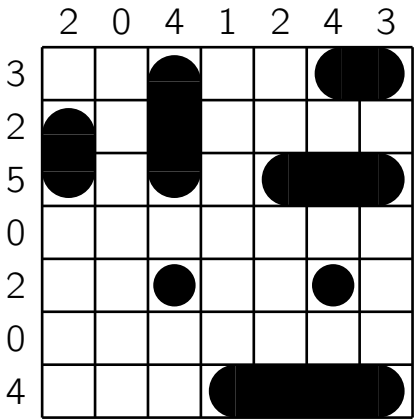

12

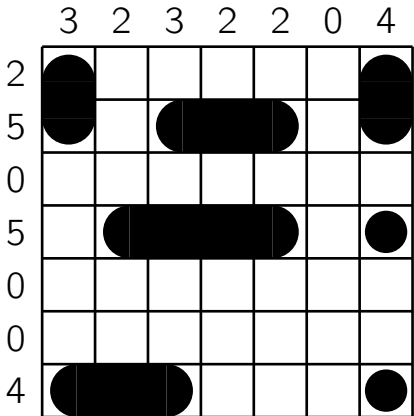

1

0	1	0	1
0	0	1	1
1	1	0	0
1	0	1	0

2

1	1	0	0
0	0	1	1
0	1	1	0
1	0	0	1

3

0	1	0	1
1	0	0	1
1	0	1	0
0	1	1	0

4

0	1	1	1	1	1
1	0	0	1	1	0
1	0	1	0	0	1
0	1	0	1	1	0
0	1	1	0	0	1
1	0	1	1	0	0

5

1	1	0	0	1	0
1	0	0	1	0	1
0	1	1	0	0	1
0	1	0	1	1	0
1	0	1	1	0	0
0	0	1	0	1	1

6

0	1	1	0	0	1	0	1
1	1	0	0	1	0	1	0
0	0	1	1	0	0	1	1
0	1	0	1	0	1	0	1
1	0	1	0	1	0	1	0
0	0	1	0	1	1	0	1
1	1	0	1	0	1	0	0
1	0	0	1	1	0	1	0

7

1	0	1	0	1	0
0	0	1	0	1	1
1	1	0	1	0	0
1	0	1	1	0	0
0	1	0	0	1	1
0	1	0	1	0	1

8

0	0	1	1	0	1
1	0	1	1	0	0
0	1	0	0	1	1
0	1	1	0	0	1
1	0	0	1	1	0
1	1	0	0	1	0

9

0	0	1	1	0	1
1	0	0	1	1	0
0	1	1	0	1	0
0	1	1	0	0	1
1	0	0	1	0	1
1	1	0	0	1	0

10

1	0	1	0	1	0
0	1	1	0	1	0
1	0	0	1	0	1
1	0	1	1	0	0
0	1	0	0	1	1
0	1	0	1	0	1

11

1	1	0	0	1	1	0	0
1	0	1	1	0	1	0	0
0	0	1	1	0	0	1	1
0	1	0	0	1	1	0	1
1	0	1	0	1	0	1	0
0	1	0	1	0	0	1	1
1	1	0	1	0	1	0	0
0	0	1	0	1	0	1	1

12

1	1	0	0	1	0	1	0
0	1	1	0	0	1	0	1
1	0	0	1	1	0	1	0
1	0	1	1	0	0	1	0
0	1	0	0	1	1	0	1
1	0	1	0	1	1	0	0
0	1	0	1	0	0	1	1
0	0	1	1	0	1	0	1

13

0	1	1	0	1	0
1	0	1	0	0	1
0	1	0	1	0	1
1	1	0	0	1	0
0	0	1	1	0	1
1	0	0	1	1	0

14

0	1	0	0	1	1
1	0	0	1	1	0
0	1	1	0	0	1
0	0	1	1	0	1
1	1	0	0	1	0
1	0	1	1	0	0

15

0	1	0	0	1	1
1	0	0	1	1	0
0	1	1	0	0	1
0	0	1	1	0	1
1	1	0	0	1	0
1	0	1	1	0	0

16

0	1	1	0	1	0	0	1
1	1	0	1	0	1	0	0
0	0	1	1	0	0	1	1
0	0	1	0	1	1	0	1
1	1	0	1	0	0	1	0
0	1	0	0	1	1	0	1
1	0	1	0	0	1	1	0
1	0	0	1	1	0	1	0

17

0	0	1	1	0	1
0	1	0	1	1	0
1	0	1	0	0	1
0	1	0	1	0	1
1	1	0	0	1	0
1	0	1	0	1	0

1

2	1	6	6	4	5
5	6	1	2	3	4
1	2	3	4	5	6
6	5	4	1	3	3
4	3	2	5	6	1
3	4	5	6	1	2

6

4	5	1	2	3	6
2	3	6	1	4	5
1	4	3	6	5	2
6	2	5	4	1	3
5	6	4	3	2	1
3	1	2	5	6	4

2

2	1	5	4	6	3
1	6	3	2	5	4
6	3	4	1	2	5
4	5	2	6	3	1
3	4	6	5	1	2
5	2	1	3	4	6

7

2	5	1	4	6	3
5	4	3	6	1	2
1	2	4	3	5	6
4	1	6	2	3	5
6	3	2	5	4	1
3	6	5	1	2	4

3

1	6	2	5	4	3
3	5	6	4	1	2
5	2	1	6	3	4
6	3	4	1	2	5
4	1	3	2	5	6
2	4	5	3	6	1

8

4	5	2	1	6	3
1	6	3	5	4	2
2	1	6	3	5	4
6	3	4	2	1	5
3	4	5	6	2	1
5	2	1	4	3	6

4

1	4	5	6	3	2
5	6	3	2	1	4
3	2	1	4	5	6
4	5	6	3	2	1
6	3	2	1	4	5
2	1	4	5	6	3

9

2	3	1	4	5	6
4	5	6	3	2	1
3	6	2	5	1	4
5	4	3	1	6	2
1	2	5	6	4	3
6	1	4	2	3	5

5

1	6	4	3	5	2
6	1	2	5	4	3
3	4	1	2	6	5
4	2	5	6	3	1
2	5	3	4	1	6
5	3	6	1	2	4

10

3	6	1	4	5	2
6	4	3	2	1	5
5	2	4	1	3	6
4	5	6	3	2	1
2	1	5	6	6	3
1	3	2	5	6	4

11

4	5	3	2	6	1
2	1	4	6	5	3
3	4	6	5	1	2
6	3	2	1	4	5
5	2	1	4	3	6
1	6	5	3	2	4

16

2	5	4	1	6	3
4	2	3	6	5	1
6	3	2	5	1	4
5	1	6	4	3	2
3	6	1	2	4	5
1	4	5	3	2	6

12

1	4	5	6	2	3
5	3	2	1	4	6
3	6	4	5	1	2
4	2	1	3	6	5
6	1	3	2	5	4
2	5	6	4	3	1

17

5	6	3	2	1	4
6	2	5	4	3	1
1	4	2	3	5	6
3	1	6	5	4	2
4	5	1	6	2	3
2	3	4	1	6	5

13

3	4	2	1	5	6
2	1	6	3	4	5
4	3	5	6	2	1
6	5	4	2	1	3
5	6	1	4	3	2
1	2	3	5	6	4

14

5	2	3	6	4	1
1	3	6	4	5	2
6	5	2	3	1	4
4	6	1	2	3	5
2	1	4	5	6	3
3	4	5	1	2	6

15

1	6	2	5	3	4
5	1	6	3	4	2
6	5	4	1	2	3
4	2	3	6	5	1
2	3	1	4	6	5
3	4	5	2	1	6

1

B	D	B	A
C	C	C	●A
D	D	B	A
A	D	C	B

2

B	C	D	D
A	B	D	B
A	●C	C	●A
A	●C	B	D

3

C	●A	D	D	
C	B	C	●A	
●	A	D	D	B
B	C	B	A	

4

A	B	C	B	
●	C	D	D	A
B	D	B	A	
D	A	●C	C	

5

A	●C	B	D
B	D	D	A
C	D	B	C
B	A	A	●C

6

C	C	B	A
D	B	A	D
C	D	A	D
B	C	B	A

7

D	A	D	A
D	C	B	C
C	B	A	B
D	C	B	A

8

A	D	B	C	
D	B	A	B	
A	A	D	C	
●	C	D	B	C

9

B	E	B	A	D	C		
●	D	E	E	C	F	E	
C	●	A	●	A	F	B	C
A	C	F	D	A	F		
B	F	D	E	D	D	●	
B	A	●	E	F	C	B	

10

B	B	F	C	B	F		
C	E	D	A	●	E	C	
D	F	A	C	F	D		
F	E	●	A	F	A	D	
D	C	A	C	D	E		
●	B	E	B	E	●	A	B

11

B	●	D	C	A	D	●	B
F	A	F	F	E	B		
E	F	E	D	E	C		
C	E	C	A	F	D		
B	●	A	D	D	F	C	
A	C	E	●	B	B	A	

12

B	C	D	F	D	●	B
B	E	F	E	C	E	
F	D	A	●	A	A	B
C	●	A	C	F	C	E
B	E	F	A	D	●	A
F	C	D	D	E	B	



13

E	D	A	A	B	A
D	C	F	B	C	B
E	E	B	C	E	D
F	B	C	F	D	F
A	F	A	D	E	C
B	F	A	E	C	D

14

E	D	E	F	A	B
D	C	E	B	F	F
A	F	B	C	A	A
A	B	C	F	D	E
B	C	E	D	E	C
A	B	D	F	C	D

15

C	F	E	B	D	A
D	F	E	F	D	A
E	B	E	A	B	C
D	F	C	B	E	D
C	B	A	B	D	F
E	A	C	F	A	C

16

A	C	A	D	F	B
C	E	F	D	C	D
A	B	A	B	B	F
D	D	C	E	E	C
F	C	F	D	E	A
E	B	E	F	B	A

17

B	F	D	E	E	A	E	G
B	A	F	H	D	C	D	G
E	H	A	B	G	F	H	F
F	G	B	D	E	B	H	E
G	C	A	C	G	C	H	B
H	C	H	H	B	F	F	C
D	A	E	A	E	D	A	D
G	F	C	C	B	G	D	A

18

E	C	H	A	E	F	C	C
D	G	G	D	E	H	B	G
H	B	F	G	E	F	D	B
F	H	A	D	C	H	B	A
C	C	B	G	B	D	F	A
F	D	H	A	E	A	G	E
A	G	D	E	H	D	C	H
B	B	F	E	A	G	F	C

19

E	D	H	F	C	F	A	B
C	G	B	H	C	D	G	B
H	G	F	A	B	H	D	F
A	D	G	D	G	A	E	E
E	E	E	C	B	E	H	A
F	H	F	H	D	A	D	G
C	B	D	B	F	G	C	F
C	G	B	A	A	E	H	C

1

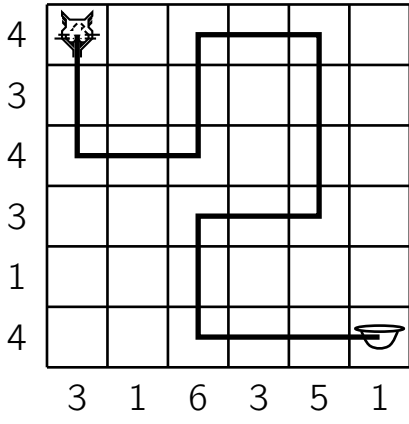

2

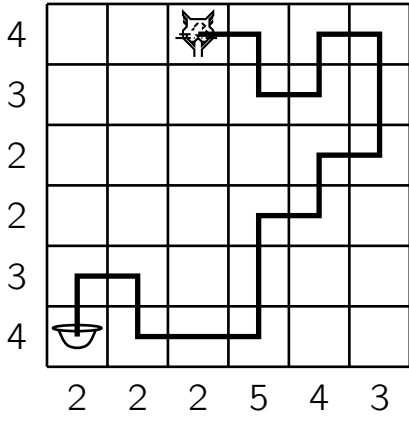

3

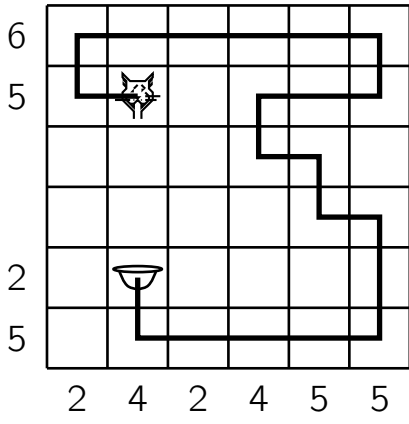

4

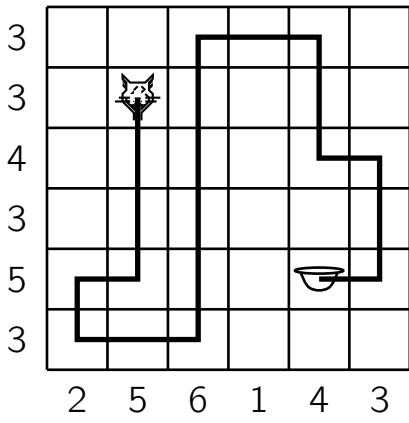

5

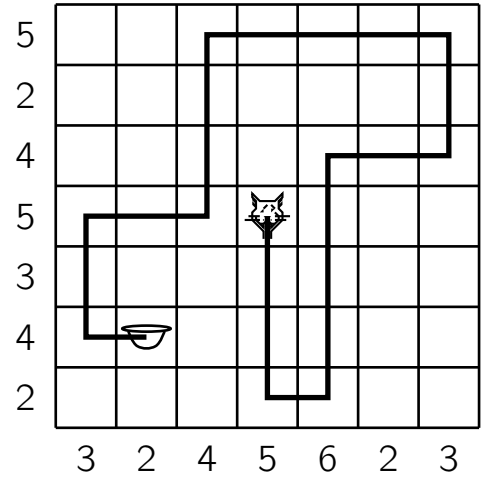

6

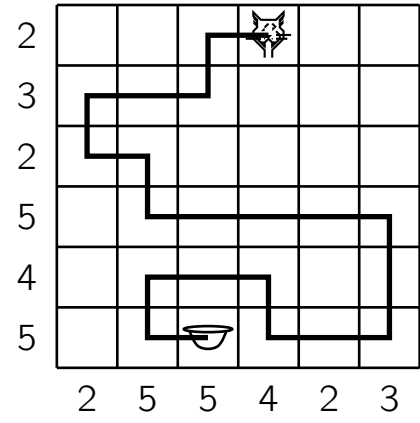

7

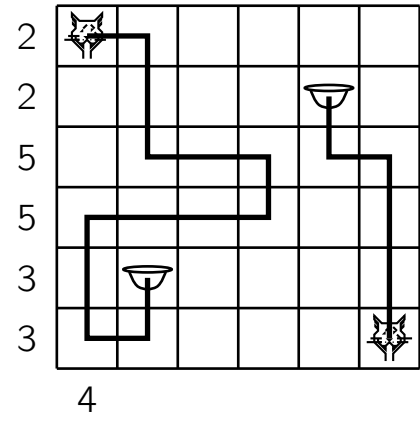

8

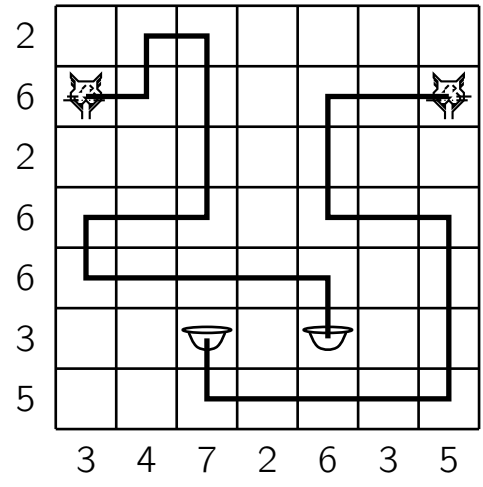

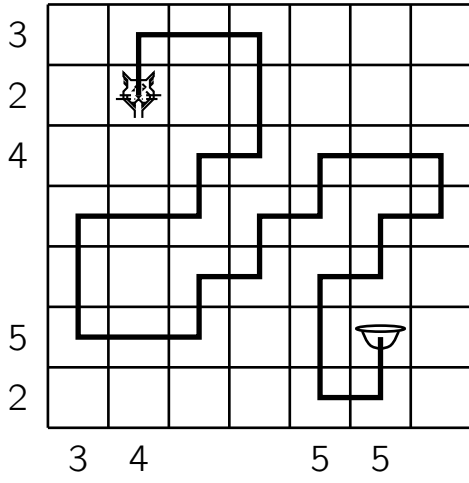

9

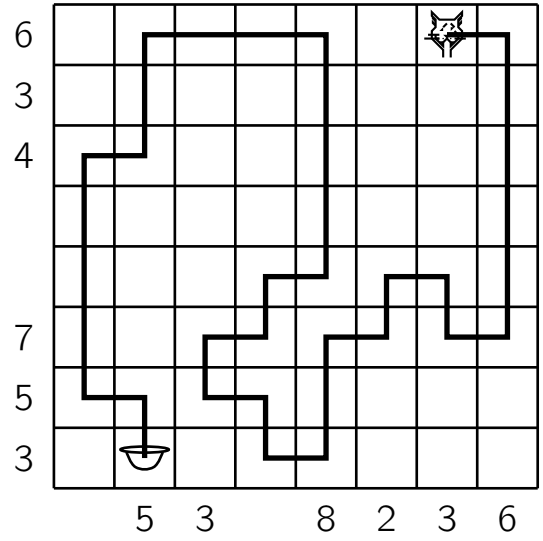

12

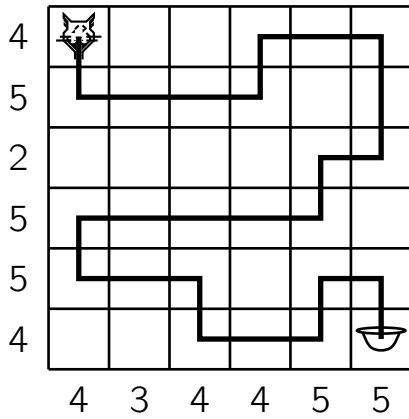

10

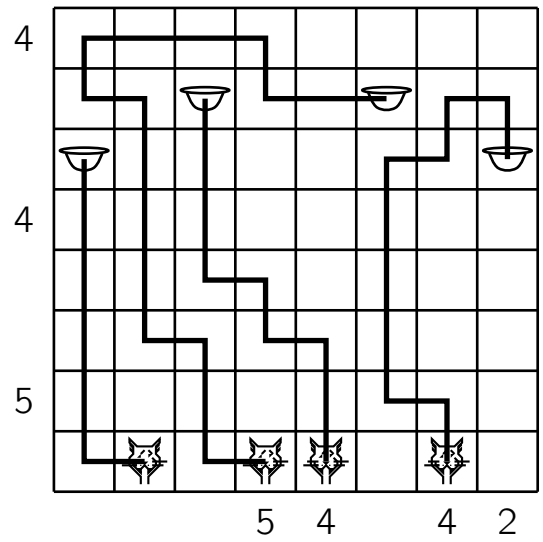

13

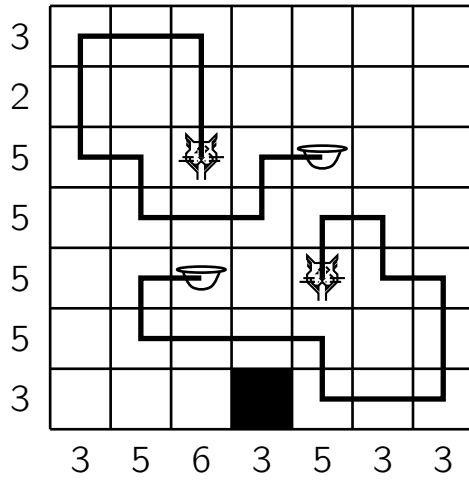

11

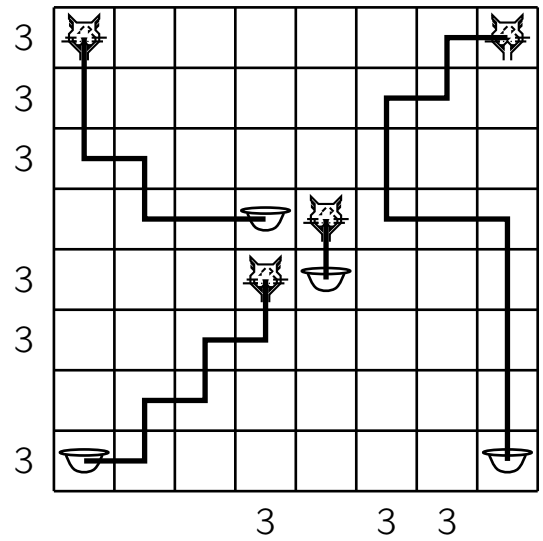

14

1

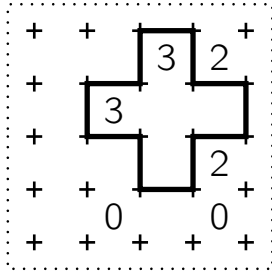

2

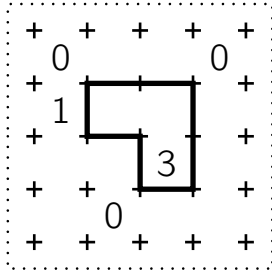

3

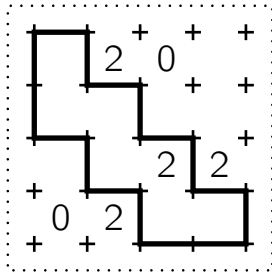

4

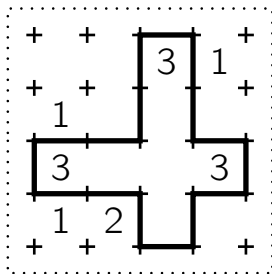

5

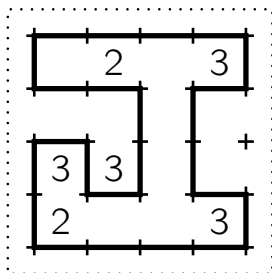

6

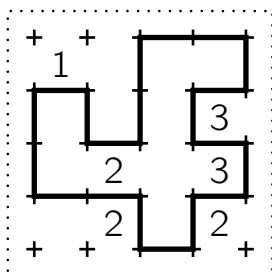

7

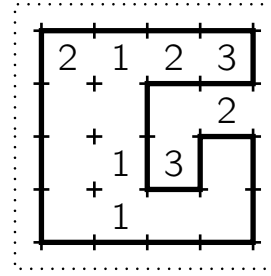

8

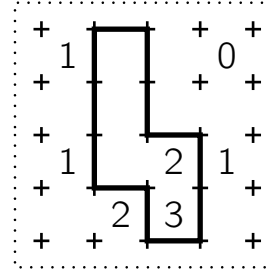

9

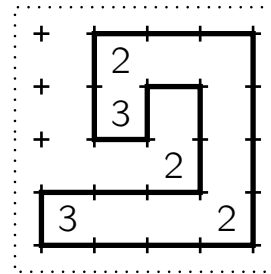

10

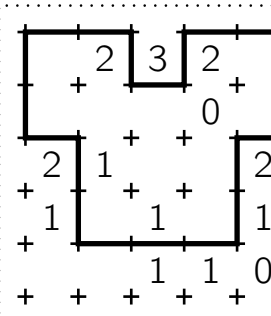

11

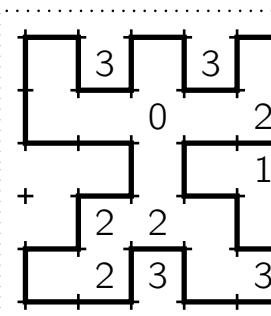

12

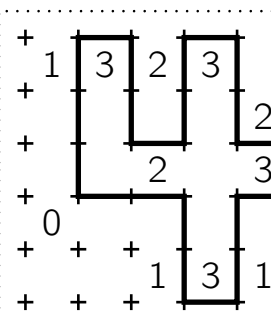

13

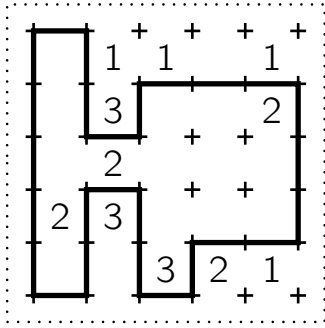

18

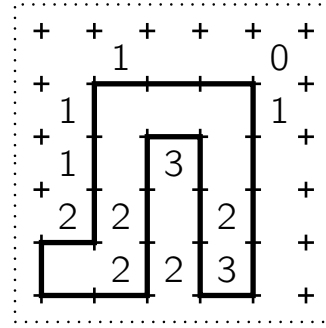

14

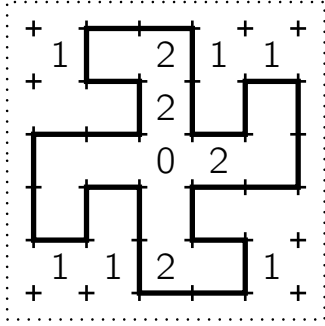

19

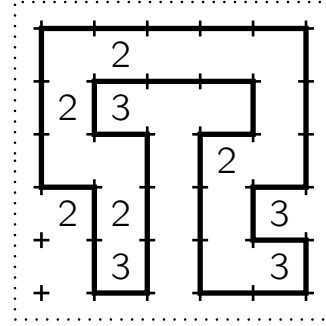

15

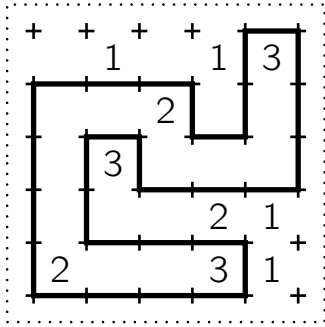

16

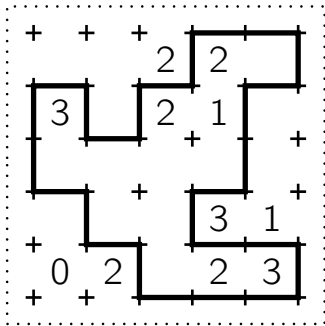

17

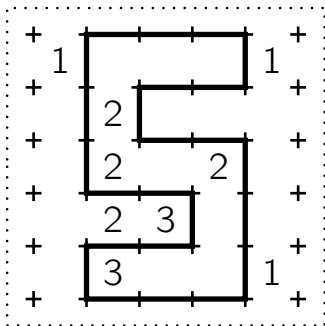

1

			☀
☀	1		2
3		2	☀
☀	☀		

2

☀	☀		2	☀
2	2		2	☀
☀	2		2	2
☀	2		☀	☀

3

1	3	☀	2	
☀		☀		0
		2		
2	☀			
☀	3	☀	1	0

4

	0		☀	2
1		4	☀	
	☀	☀	3	2
3	☀	4		
☀	2		☀	1

5

		☀		0
1	4	☀	4	
	☀	☀	☀	3
1		4	☀	☀
	0			2

6

0		☀	2	1
		3	☀	
☀	3	3	☀	☀
☀	☀	3	3	
	3	☀		0

7

2	☀	☀	☀	☀
4	☀		3	
☀	☀		0	
4	5	4		1
☀	☀	☀	☀	

8

2	☀		2	☀
☀	4		3	☀
3	☀	☀		
☀	5	3	3	☀
☀	3	☀		1

9

2	2		☀	2
☀	☀	4	☀	2
☀	☀		1	1
2		3		1
0		☀	☀	

10

☀	1	2	☀	
	3	4	☀	2
1	☀	☀	3	
2		3		☀
☀	2	☀	2	1

11

2	☀			
☀		1		
	2			
		☀	1	

12

1		☀	☀	2
	☀	5	☀	
3	☀			2
☀		1		☀
1				1

13

☀			☀	☀
1		4	☀	4
		☀	☀	
2	☀	5		1
	☀	☀		

14

			2		
☀	3	☀	☀		2
1		☀	5	☀	☀
		1		☀	3
1				1	
	☀	1			

15

☀	☀		1	☀	☀
2		1		5	☀
	1			☀	☀
		☀		2	
	1		3		1
		1	☀	☀	

16

☀	2	1		
	4	☀	3	☀
1	☀	☀		2
		5	☀	
1	☀	3	☀	2

17

		2	☀	
1		☀		3
☀		3	☀	☀
4	☀			4
☀	☀	3	☀	☀

18

		☀	3	☀	
	1		☀	3	
		2		☀	2
1		☀	4	☀	
☀	3	☀		1	
		1			

19

☀	☀		1	☀	☀
2		1		5	☀
	1			☀	☀
		☀		2	
	1		3		1
		1	☀	☀	

20

1		☀	☀		1
	☀	4	3		☀
	3	☀		1	
	3	☀		1	
	☀	5	4	☀	
2	☀	☀	☀		1

1

		2	
	4		3
1			
	1		2

2

		2	
		5	2
3			
	3		

3

0				2
	4			
		3		
			2	
3				0

4

2				1
		4	2	
2	2			
		2	2	
	2			1

5

	2		3		1
	3		2		4
	3		2		2

6

0			2		1
	4			4	
			3		
		2			
	2			3	
1		2			2

7

	2			3	
					1
1			1		
		3			2
0					
	1			3	

8

		1			
	4				
2			4		
		2			0
				3	
			1		

9

				1	
2		5			
				2	
	1				
			6		2
	3				



10

		2		2		
	1				1	
0			1			1
		3		1		
2			2			1
	3				1	
		1		1		

14

	2				1	
2		3	2	2		2
	2				2	
		1		3		
	2				2	
1		4		3		1
	2				1	

11

		2			0	
3						
		1		4		2
3		1		3		
						4
	1			1		

15

2			1			0
		2		2		
	2				2	
1			3			2
	2				2	
		4		1		
1			2			1

12

	3		2		4		
		0		5			
3						2	
			1				
0			5		2		2

16

			3		2		
	3			4		4	
1	1	3					2
				4	5	5	
	3	3	3				
2					4	4	3
	3		3			4	
		2	1				

13

	1				1
			2		
	1	2			
					1
3			2	3	
		2			

1

+	+	○	○	○	+
+	+	○	+	○	+
○	○	+	○	+	○
+	+	○	○	○	+
○	+	○	○	○	+
○	○	+	+	○	○

5

○	○	+	+	+	○
+	○	+	+	○	+
○	+	○	○	○	+
○	○	+	+	○	○
○	+	+	○	+	+
+	+	+	○	○	○

2

○	+	○	+	+	○
+	+	+	○	○	○
+	○	○	○	+	○
○	+	+	○	+	+
+	○	+	+	○	+
+	○	+	○	○	+

6

+	○	+	○	○	+
+	+	○	+	○	○
○	○	○	+	+	+
+	○	+	○	○	○
+	+	○	+	+	○
○	○	○	+	+	○

3

+	○	+	○	○	○	+
+	+	+	○	+	○	○
○	+	○	○	○	+	+
○	+	+	+	○	○	+
+	○	○	○	+	+	+
○	+	+	○	○	+	○
+	+	+	○	○	+	○

7

○	+	○	○	+	○	○
+	○	+	○	○	○	+
○	+	○	○	○	○	○
○	○	○	○	○	○	○
○	○	○	○	○	○	○
○	○	○	○	+	○	+
○	+	○	○	○	+	○

4

○	○	○	+	+	+	○
○	+	+	+	○	○	○
+	○	+	○	+	○	+
○	○	○	+	○	+	○
○	+	+	+	○	+	○
+	○	+	○	○	+	○
○	+	○	+	+	○	+

8

+	○	○	+	+	+	○	○	○
+	○	+	○	○	○	+	○	○
+	○	+	+	+	○	+	○	+
○	+	○	○	+	○	○	○	+
+	○	+	○	○	○	+	+	○
○	+	○	○	+	+	○	+	+
+	○	+	+	○	○	○	○	○
+	○	+	○	○	+	○	○	+
+	○	+	○	○	○	+	+	+

9

○	○	+	+	○	○	○	○
○	○	+	+	○	○	○	○
○	○	○	○	○	○	○	○
○	○	○	○	○	○	○	○
○	○	+	○	+	○	○	○
○	+	○	○	○	○	○	○
○	○	+	○	○	○	○	○
+	○	○	○	+	○	+	○

10

+	○	○	+	+	○	+	○
○	○	+	+	○	+	○	+
○	+	○	○	○	+	+	○
○	+	+	+	○	○	+	○
+	+	○	○	+	+	+	○
○	○	+	○	+	○	○	+
+	○	○	○	+	+	+	○
+	+	○	+	○	○	+	○

11

+	+	○	○	+	+	+	○
+	○	+	+	○	○	+	○
+	○	○	○	+	+	+	○
○	+	○	+	+	+	○	+
○	+	○	○	○	+	○	+
+	+	+	○	+	○	○	○
○	○	+	○	○	○	+	+
+	○	+	+	○	+	+	○

12

○	○	+	○	+	○	○	○	+	○
+	+	○	○	○	+	+	○	○	+
○	+	+	+	○	+	+	+	○	+
○	+	+	○	+	+	+	○	+	+
+	○	○	○	+	○	○	+	+	○
○	+	○	○	○	+	○	○	○	+
+	+	○	+	+	○	○	○	+	+
○	+	+	○	+	+	+	○	+	○
○	○	○	+	+	○	+	+	○	+
+	○	+	+	○	+	○	○	+	+

13

+	○	○	○	+	+	○	+	+
+	○	+	+	○	○	○	+	+
○	+	○	○	+	+	○	+	+
+	+	○	+	○	+	+	○	○
+	+	○	+	○	○	○	+	+
○	○	+	○	+	○	+	+	○
+	○	○	○	+	○	○	○	+
+	+	+	○	○	+	+	+	○
○	+	+	+	○	○	+	+	○

14

+	○	○	○	+	+	○	○	○
○	+	+	○	+	+	○	+	○
○	+	+	+	○	○	+	+	+
+	+	○	○	+	+	○	○	+
○	○	+	○	○	○	+	+	○
+	○	+	○	+	○	○	+	○
○	○	+	+	○	+	+	○	○
+	+	○	○	○	+	○	○	+
+	+	+	○	○	+	○	+	+

1

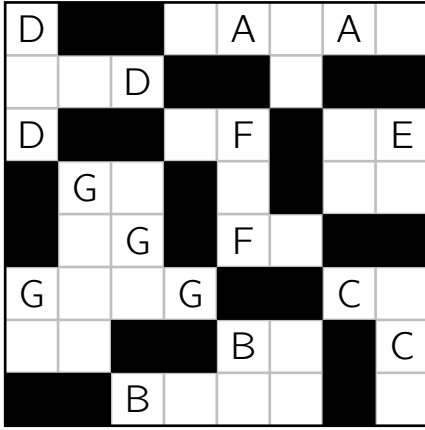

4

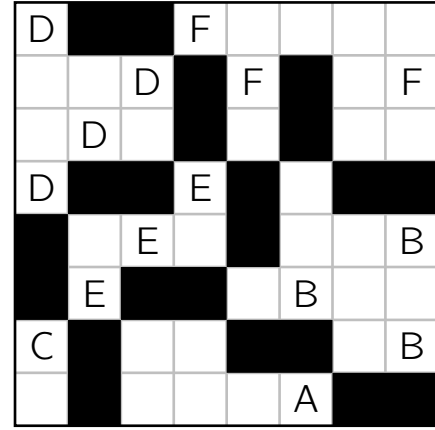

2

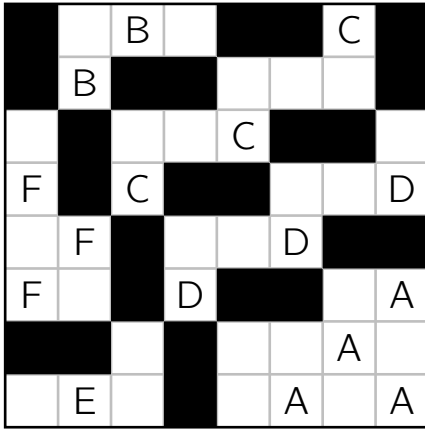

5

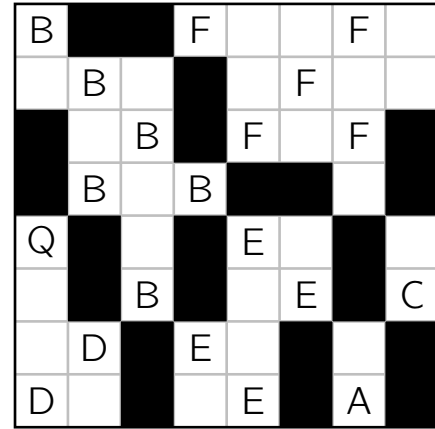

3

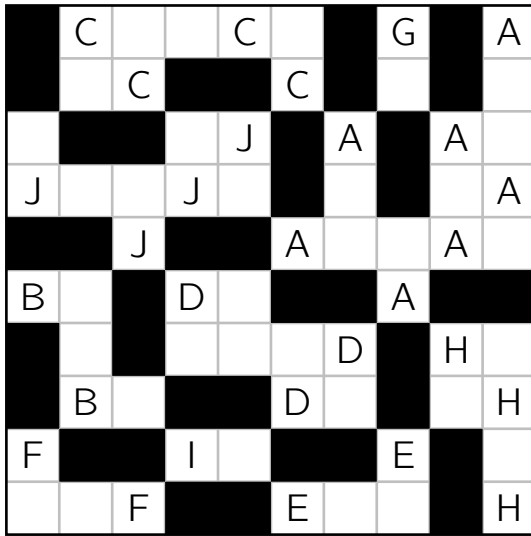

6

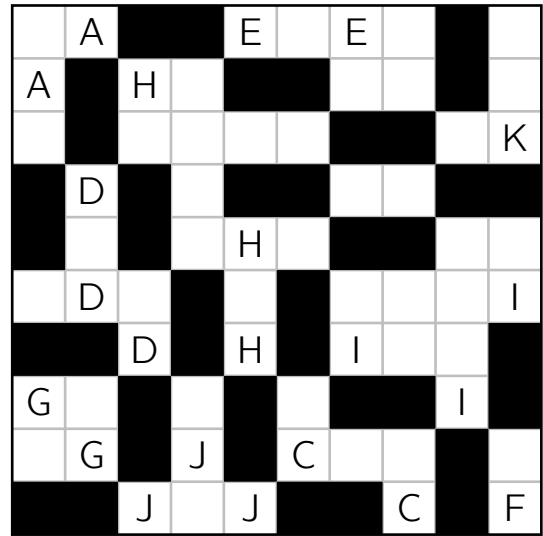

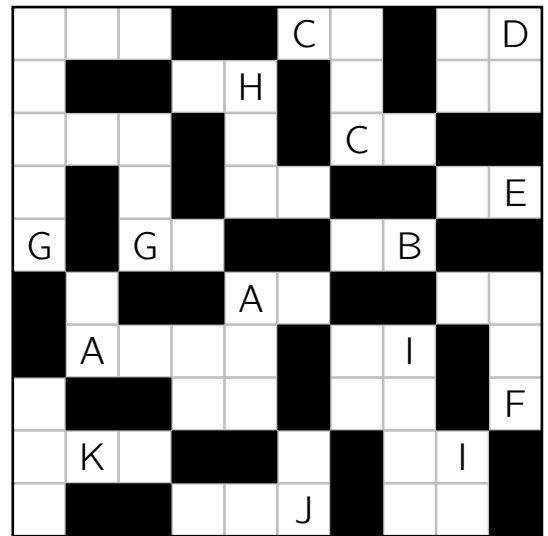
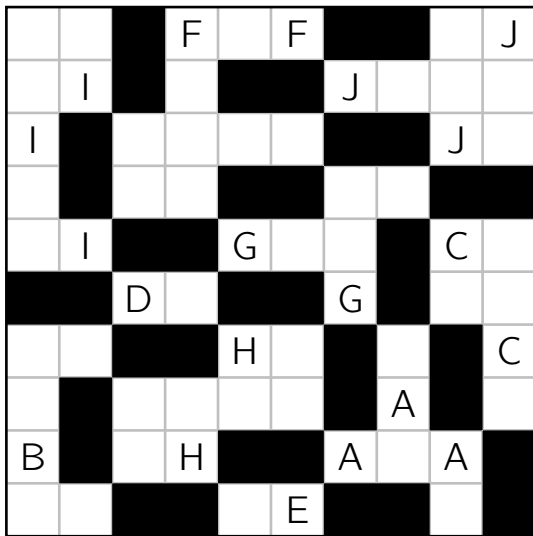
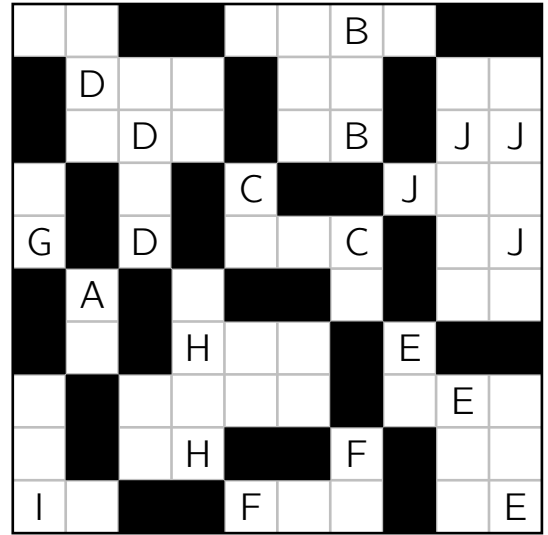
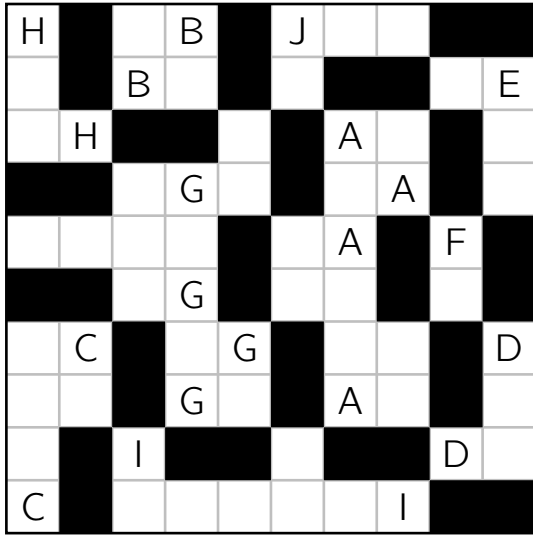
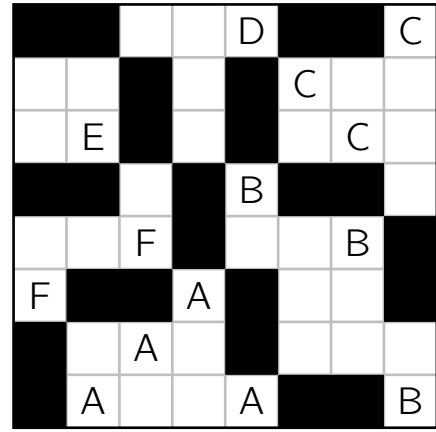
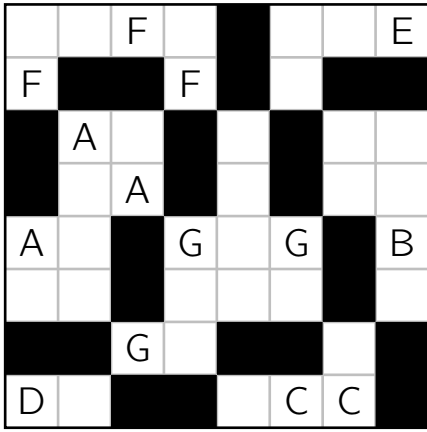

1	:	1	0	3	:	0
3	:	3	0	1	:	1
1	:	2	3	2	:	0
2	:	2	3	2	:	0

1

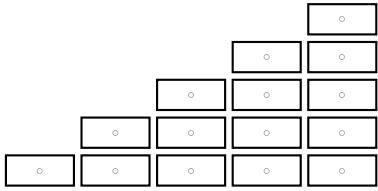

3	2	2	1	3
1	1	0	2	2
2	3	3	0	0
1	3	1	0	0

2

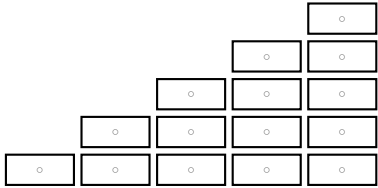

4	1	4	4	4	1
3	3	1	1	1	4
0	3	0	3	2	2
0	3	0	3	4	0
2	0	2	1	2	2

3

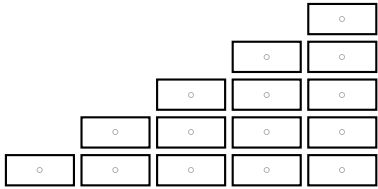

4

3	3	3	2	4	3
2	0	1	1	0	2
4	0	4	0	4	4
3	4	0	3	0	1
2	1	1	2	2	1

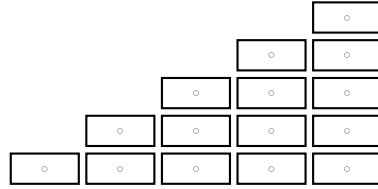

5

2	2	0	0	1	4
1	0	0	0	1	3
1	4	1	4	0	4
1	2	2	4	3	2
3	3	4	3	2	3

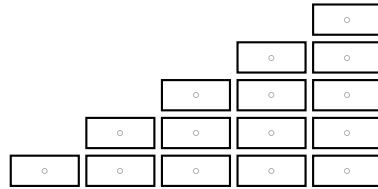

6

3	0	2	3	2	0
4	1	4	0	3	4
4	1	1	2	2	4
2	3	1	0	1	2
0	0	1	4	3	3

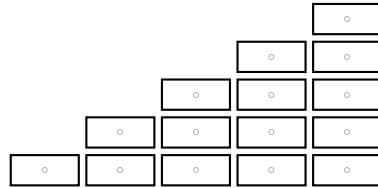

7

2	3	3	4	4	3
3	0	0	0	4	2
3	1	0	0	4	1
1	4	2	1	4	3
1	0	2	2	2	1

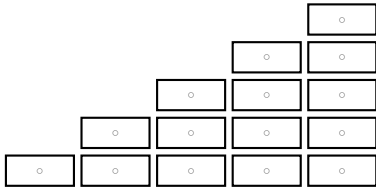

8

4	4	1	4	3	3
1	0	1	0	1	4
2	3	4	2	2	1
2	3	3	4	1	2
0	0	2	0	3	0

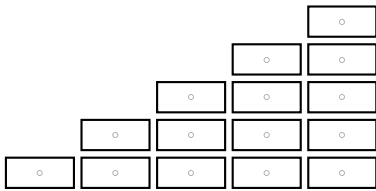

9

3	2	0	4	3	4
3	1	0	1	2	4
3	4	3	1	4	0
1	0	4	3	1	0
2	2	2	1	2	0

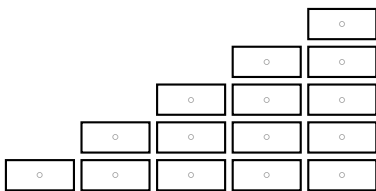

10

4	1	4	2	4	3
4	1	4	2	3	0
0	2	1	2	1	0
0	3	0	3	3	0
4	1	1	3	2	2

11

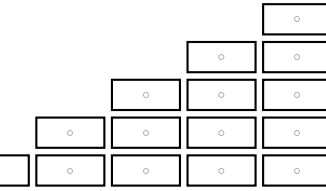

0	2	2	3	2	2
3	3	3	4	4	3
1	0	4	4	4	0
1	1	1	2	1	0
1	0	3	2	4	0

12

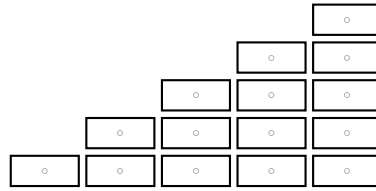

2	3	3	1	4	1
4	4	4	2	0	0
3	0	1	0	3	3
3	1	2	2	2	0
2	4	4	1	1	0

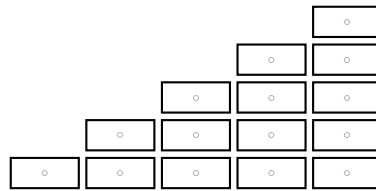

1

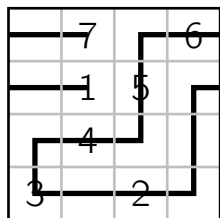

2

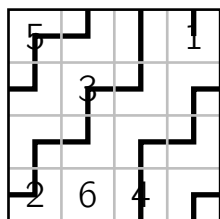

3

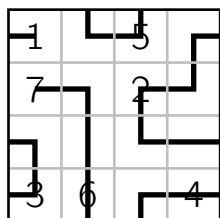

4

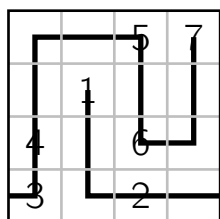

5

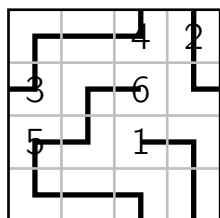

6

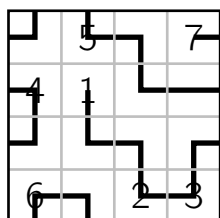

7

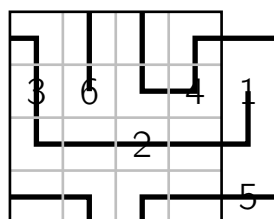

8

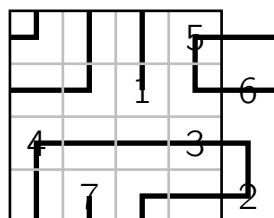

9

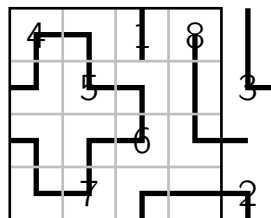

10

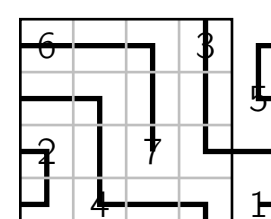

11

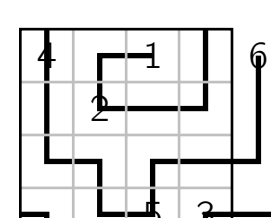

12

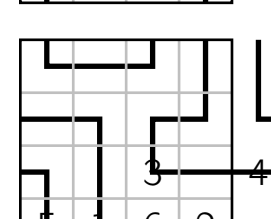

13

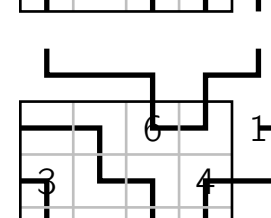

14

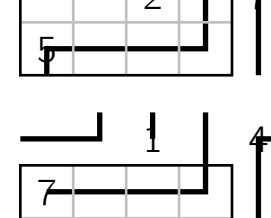

15

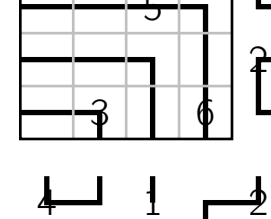



16

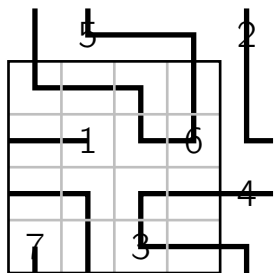

17

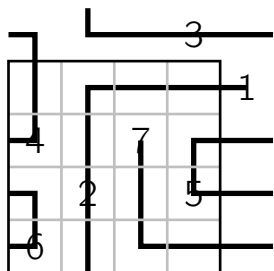

18

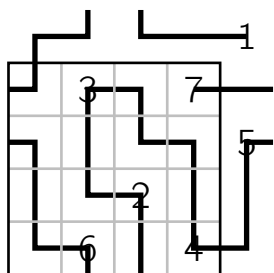

1

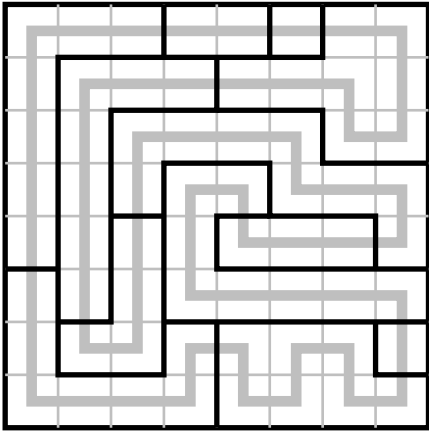

2

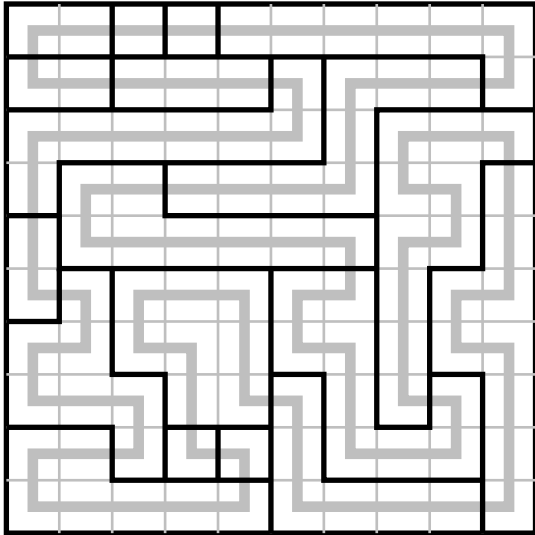

3

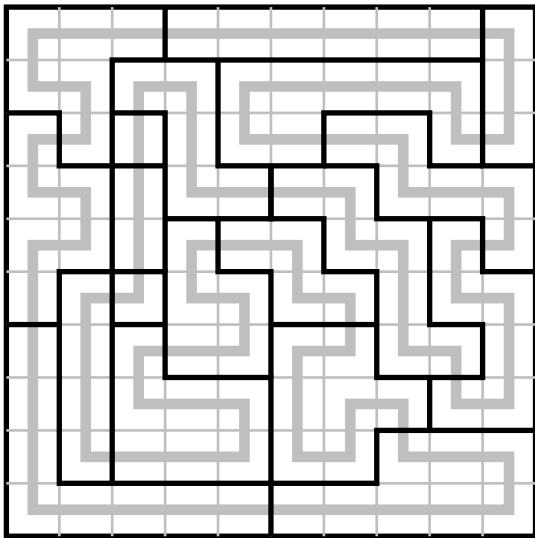

4

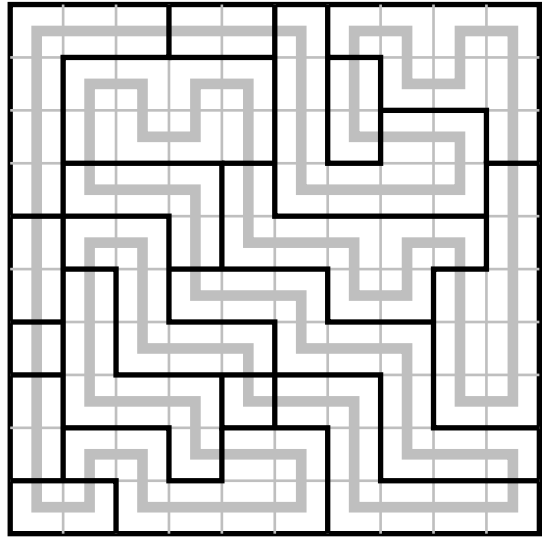

5

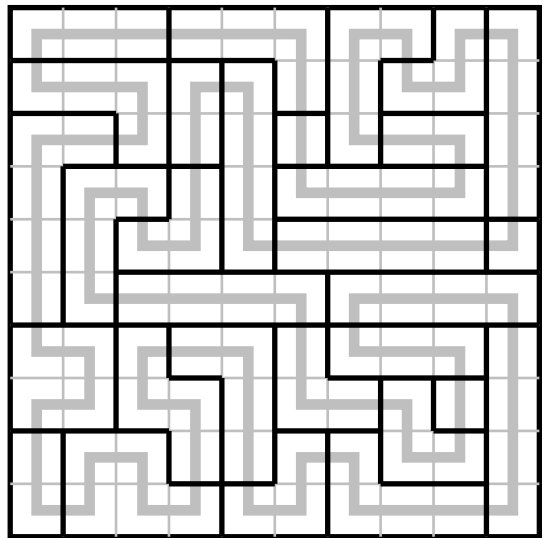

6

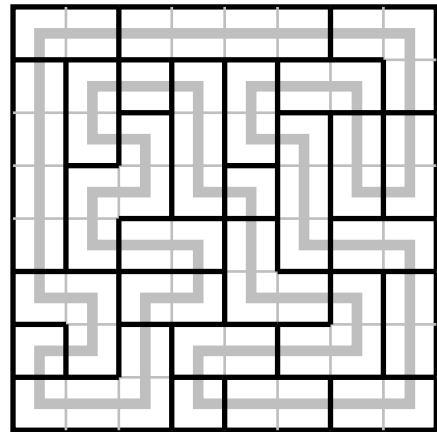

7

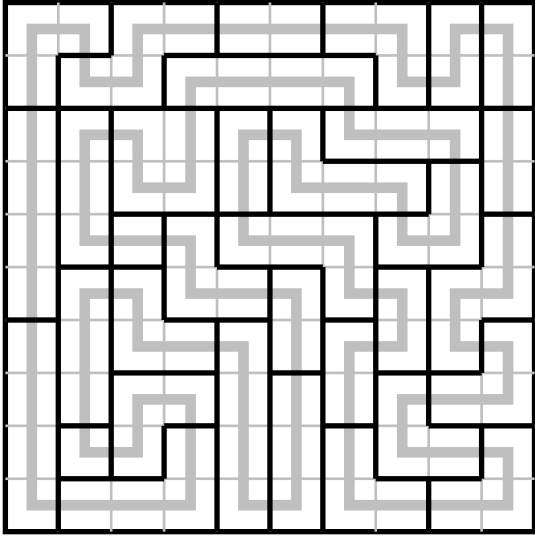

9

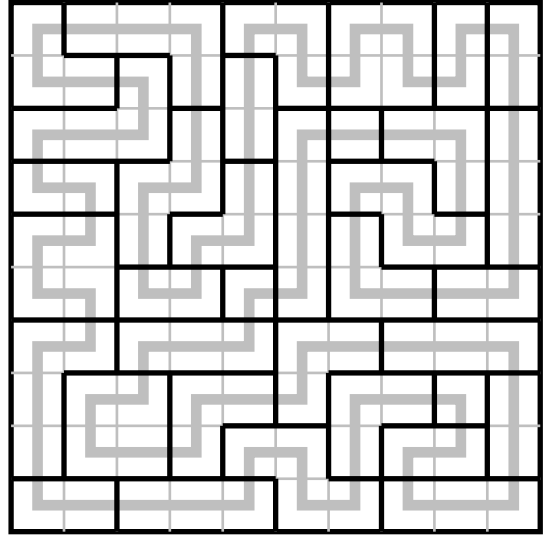

8

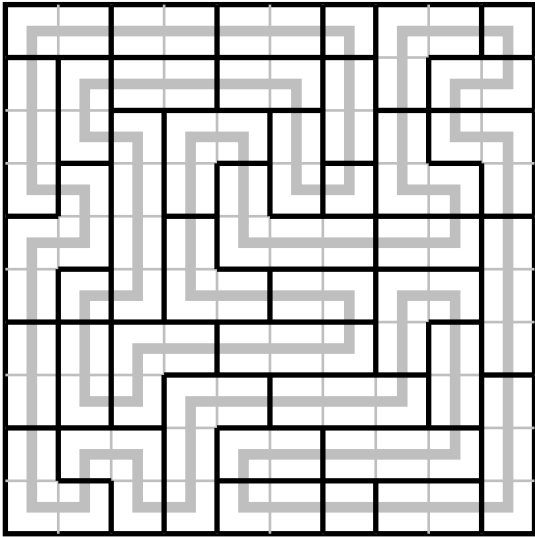

10

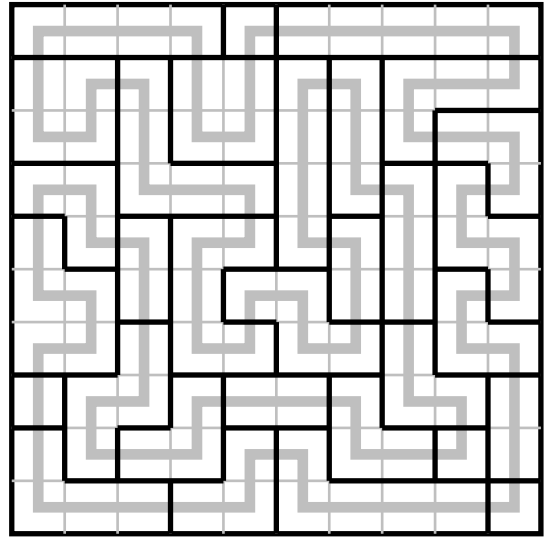

1

B 2	A 3	C 4	D 1
C 3	D 2	B 1	A 4
D 4	C 1	A 2	B 3
A 1	B 4	D 3	C 2

2

A 1	B 3	C 4	D 2
B 2	A 4	D 3	C 1
D 4	C 2	B 1	A 3
C 3	D 1	A 2	B 4

3

B 3	A 1	D 4	C 2
A 4	B 2	C 3	D 1
C 1	D 3	A 2	B 4
D 2	C 4	B 1	A 3

4

D 4	B 1	C 3	A 2
B 2	D 3	A 1	C 4
A 3	C 2	B 4	D 1
C 1	A 4	D 2	B 3

5

A 1	C 4	B 2	D 3
D 4	B 1	C 3	A 2
C 2	A 3	D 1	B 4
B 3	D 2	A 4	C 1

6

D 1	E 2	B 5	A 3	C 4
B 2	C 3	E 4	D 5	A 1
E 3	A 5	C 1	B 4	D 2
A 4	B 1	D 3	C 2	E 5
C 5	D 4	A 2	E 1	B 3

7

D 2	E 1	C 3	A 4	B 5
E 3	A 2	D 5	B 1	C 4
C 1	D 4	B 2	E 5	A 3
A 5	B 3	E 4	C 2	D 1
B 4	C 5	A 1	D 3	E 3

8

C 5	A 3	D 1	E 4	B 2
B 4	E 5	C 3	D 2	A 1
D 3	B 1	E 2	A 5	C 4
E 1	C 2	A 4	B 3	D 5
A 2	D 4	B 5	C 1	E 3

9

E 2	C 3	B 5	D 4	A 1
D 3	A 5	E 4	C 1	B 2
C 5	B 4	D 1	A 2	E 3
A 4	E 1	C 2	B 3	D 5
B 1	D 2	A 3	E 5	C 4

10

D 3	C 4	B 2	A 1
A 4	B 3	C 1	D 2
C 2	D 1	A 3	B 4
B 1	A 2	D 4	C 3

11

D 1	C 2	A 3	B 4
C 4	D 3	B 2	A 1
A 2	B 1	D 4	C 3
B 3	A 4	C 1	D 2

12

D 4	C 1	A 3	B 2
B 3	A 2	C 4	D 1
C 2	D 3	B 1	A 4
A 1	B 4	D 2	C 3

13

A 3	D 4	B 1	C 2
D 2	A 1	C 4	B 3
C 1	B 2	D 3	A 4
B 4	C 3	A 2	D 1

14

B 5	A 4	C 3	E 2	D 1
D 4	C 1	B 2	A 5	E 3
C 2	E 5	A 1	D 3	B 4
E 1	B 3	D 5	C 4	A 2
A 3	D 2	E 4	B 1	C 5

15

B 1	E 2	A 3	D 4	C 5
D 5	C 1	B 2	E 3	A 4
E 4	A 5	D 1	C 2	B 3
C 3	B 4	E 5	A 1	D 2
A 2	D 3	C 4	B 5	E 1

16

D 5	C 3	E 2	A 1	B 4
B 2	E 5	A 4	D 3	C 1
A 3	B 1	C 5	E 4	D 2
C 4	A 2	D 1	B 5	E 3
E 1	D 4	B 3	C 2	A 5

17

C 3	D 1	B 2	A 4
B 4	A 2	C 1	D 3
A 1	B 3	D 4	C 2
D 2	C 4	A 3	B 1

18

E 3	B 1	D 4	C 2	A 5
B 2	A 3	C 5	E 4	D 1
A 4	D 2	E 1	B 5	C 3
C 1	E 5	A 2	D 3	B 4
D 5	C 4	B 3	A 1	E 2

1

	1	4	5	7	2	3	6	10	8	9
3					6					
1						3				
7					14					
6						18				
9	9	36	45	63			54	90	72	
2						6				
5					10					
10						30				
8					16					
4										

4

	4	5	2	7	6	3	9	8	1	10
4	16									
6			12	42	36	18				
3		15								
5		25								
10		50								
7		35								
9							81			
1									1	
8								64		
2										

2

	8	10	6	3	5	4	1	7	2	9
9		90		27		36		63		
2									4	
8	64									
3									6	
10	80									
8									12	
1	8									
5									10	
4			24		20		4			
7										

5

	6	7	2	3	8	1	5	4	10	9
1						1				
5							25			
10									100	
6	36									
3										
7		49								
2			4							
9										81
4								16		
8					64					

3

	6	2	4	9	3	7	10	8	1	5
2		10								
5								64		
8		2								
1										
7						49				
3		6								
9				81						
10		20								
4			16		12		40		4	
6	36									

6

	1	3	9	10	6	2	5	7	8	4
7						14				
2						4				
3	3	9	27		18		15	21	24	12
6						12				
1						2				
9						18				
8						16				
4										
5						10				
10						20				

7

	6	5	9	3	10	8	7	1	4	2
9	54			27						
1			9							
3		15								
6						42				
7					56					
5				50						
10									20	
8								32		
4							4			
2										

10

	8	9	6	4	10	3	7	2	1	5
7	56									35
4									4	
5								10		
2					20					
3						9				
9							63			
8				32						
10			60							
6		54								
1										

8

	10	5	1	7	6	4	3	8	2	9
6	60							48		
8					32					
4				28						
10		50								
5								10		
7						21				
1				6						
9			9							
2									18	
3										

11

	6		15							
		21								
										30
									28	
								40		
							10			
							8			
						48				
					18					

9

	4	7	10	9	2	1	5	3	8	6
8	32									48
2									16	
6		42								
7								21		
4			40							
10							50			
5				45						
9						9				
3					6					
1										

12

	9	1	5	6	2	8	7	3	10	4
2										8
7	63									
4		4								
3			15							
10				60	20					
5						40				
6							42			
9								27		
1									10	
8										

1

1	4	4	4	2
4	3	3	4	2
4	4	3	1	3
4	1	2	2	3
3	3	3	1	3

6

4	4	4	2	1
2	4	1	2	4
2	3	4	4	4
3	3	1	2	2
2	2	3	3	3

2

1	2	1	4	4
3	2	4	4	3
3	4	2	2	3
3	4	4	4	3
1	3	3	3	1

7

2	2	1	2	2
4	3	3	3	4
4	4	4	2	4
3	3	3	2	4
1	2	2	1	4

3

1	3	4	4	4
4	3	2	2	4
4	3	1	3	3
4	2	2	3	4
4	1	4	4	4

8

4	4	1	4	4
4	1	2	2	4
4	3	3	3	4
2	1	2	2	1
2	4	4	4	4

4

3	2	2	1	4
3	3	4	4	4
2	2	3	2	2
3	1	3	3	4
3	3	4	4	4

9

2	1	3	1	4
2	4	3	4	4
1	4	3	2	4
3	4	4	2	3
3	3	1	3	3

5

4	4	4	2	2
4	3	3	3	1
2	2	1	2	2
3	1	2	3	3
3	3	2	3	1

10

1	2	3	3	3
4	2	4	4	1
4	1	2	4	4
4	3	2	3	3
4	3	3	1	3



11

4	1	2	2	1
4	2	3	1	2
4	2	3	3	2
4	3	2	1	3
3	3	2	3	3

16

1	2	3	2	1
4	2	3	2	4
4	4	3	1	4
3	4	1	4	4
3	3	2	2	1

12

4	3	3	4	1
4	4	3	4	4
4	1	4	1	4
2	4	4	4	2
2	3	3	3	2

17

2	2	3	4	4	4	4
3	1	3	3	2	2	3
3	2	6	6	6	6	3
3	2	3	2	2	6	3
4	1	3	3	1	6	4
4	4	4	1	2	2	4
1	3	3	3	1	4	4

13

4	2	3	3	1
4	2	3	4	4
4	1	4	4	1
4	2	3	1	2
1	2	3	3	2

18

3	5	5	5	5	4	2
3	4	4	5	4	4	2
3	4	3	3	3	4	3
1	4	2	2	1	2	3
2	2	1	4	4	2	3
5	5	3	3	4	3	1
5	5	5	3	4	3	3

14

2	1	3	3	2
2	4	4	3	2
3	3	4	4	1
4	3	1	3	3
4	4	4	3	1

19

1	6	2	2	5	1	5
2	6	6	6	5	5	5
2	3	3	6	6	3	3
5	5	3	5	5	5	3
4	5	5	2	5	1	2
4	5	1	2	5	6	2
4	4	6	6	6	6	6

15

1	3	4	3	3
3	3	4	3	1
4	2	4	2	2
4	2	4	3	1
4	4	1	3	3

1

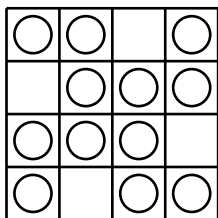

2

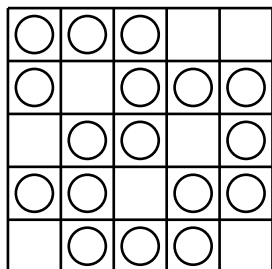

3

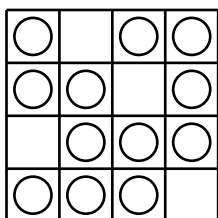

4

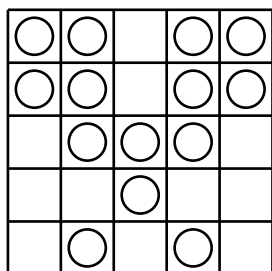

5

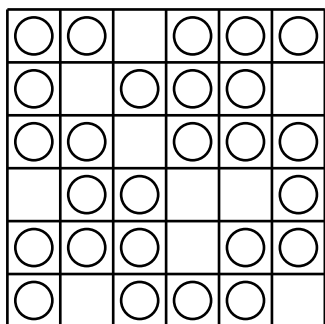

6

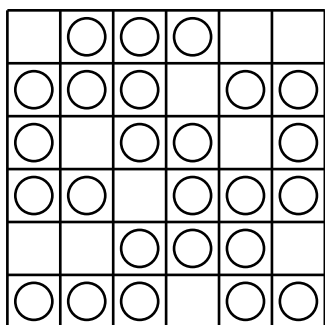

7

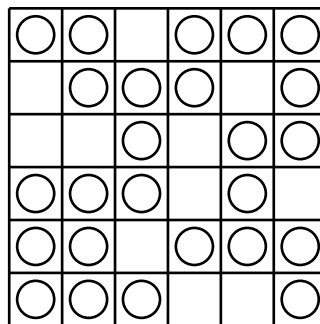

8

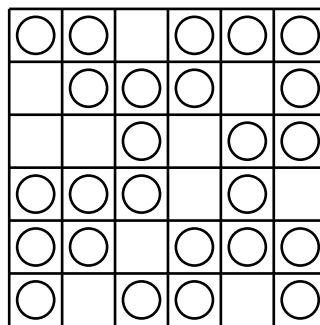

9

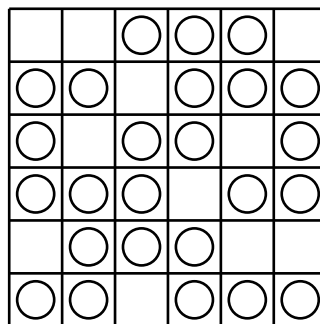

10

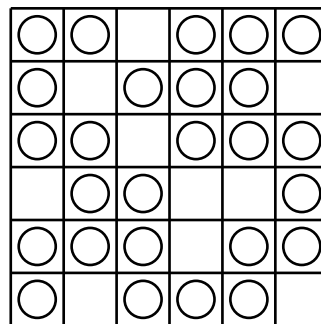

11

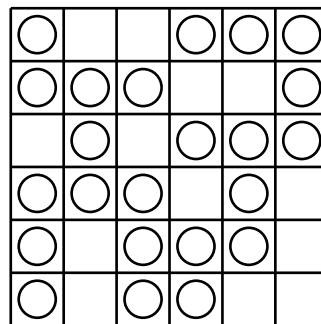

12

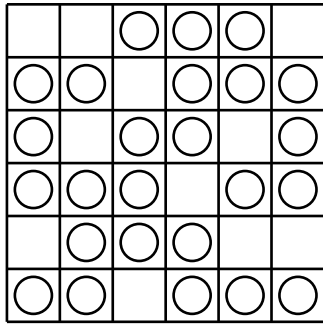

13

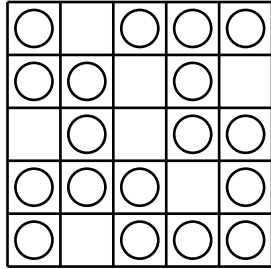

14

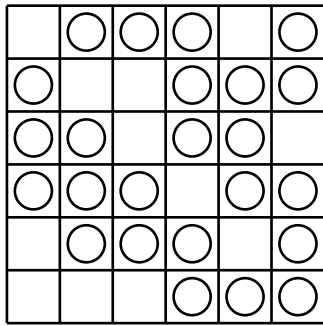

15

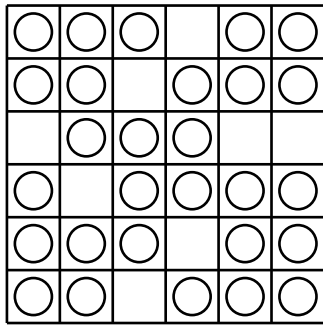

16

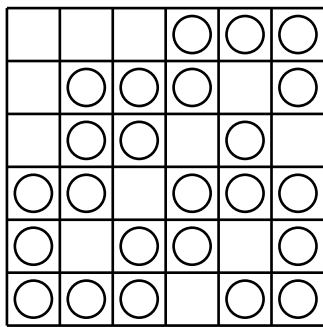

1

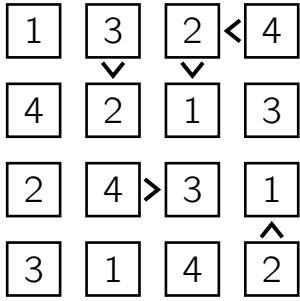

2

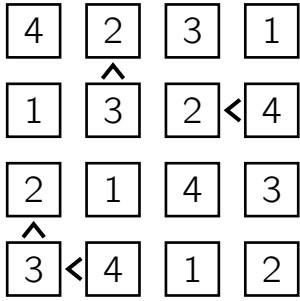

3

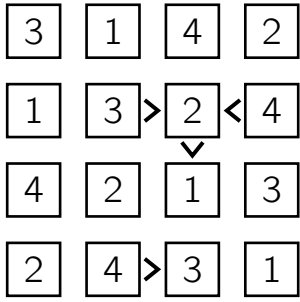

4

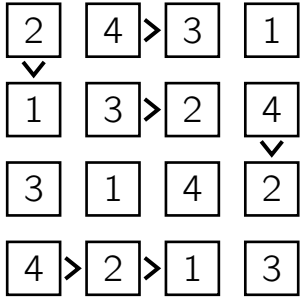

5

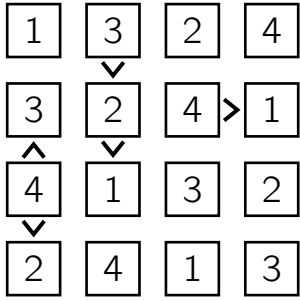

6

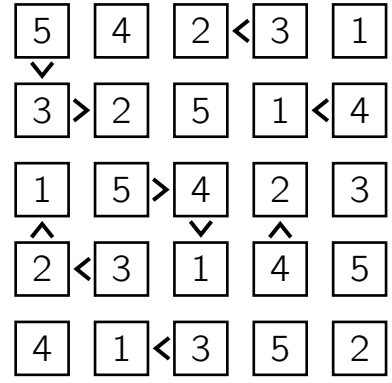

7

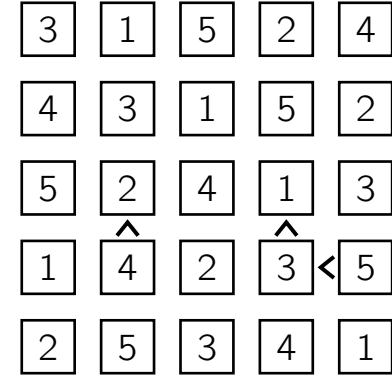

8

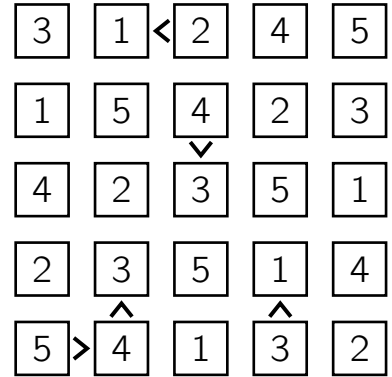

9

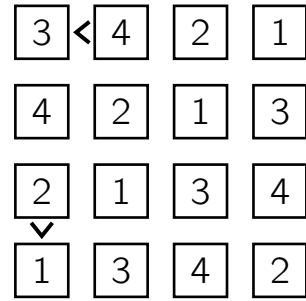

10

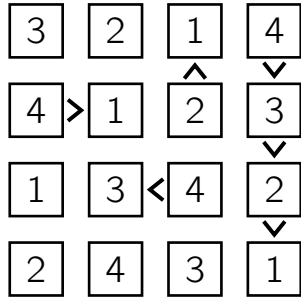

14

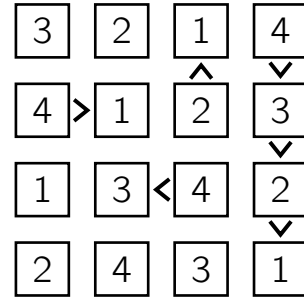

11

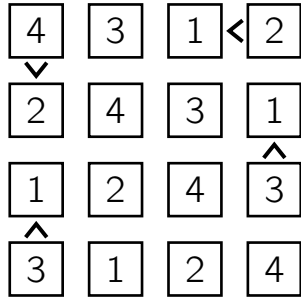

15

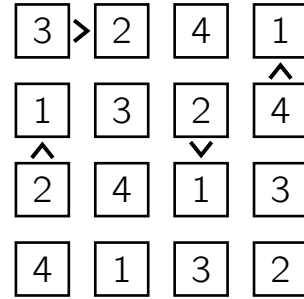

12

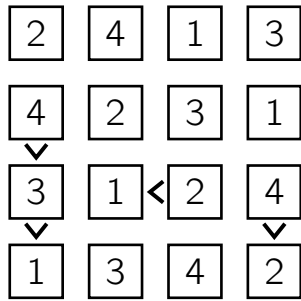

16

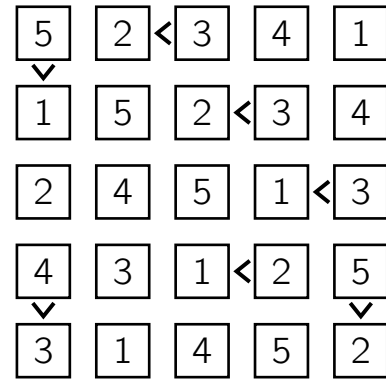

13

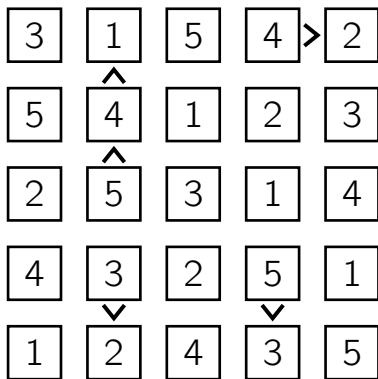

1

3		2		1
	1	3		2
	2		1	3
1	3		2	
2		1	3	

6

	1	3	2	
3		1		2
2	3			1
1		2	3	
	2		1	3

2

3	1		2	
1		2		3
2		3		1
	3		1	2
	2	1	3	

7

	2		1	3
3		2		1
1		3		2
2	1		3	
	3	1	2	

3

	2		1	3
1	3	2		
	1		3	2
3		1	2	
2		3		1

8

1		2	3	
3	2			1
2		1		3
	1	3	2	
	3		1	2

4

2			3	1
1	3	2		
	1		2	3
	2	3	1	
3		1		2

9

	2	1		3
2	3		1	
	1		3	2
1		3	2	
3		2		1

5

	1		3	2
3	2			1
		2	1	3
2	3	1		
1		3	2	

10

3		2		1
1	2	3		
	3		1	2
2		1	3	
	1		2	3

11

3	1			2
1		2	3	
	2	1		3
		3	2	1
2	3		1	

16

3	1	2		
	2		1	3
1	3		2	
		1	3	2
2		3		1

12

2	1			3
3		2	1	
1		3		2
	2	1	3	
	3		2	1

17

1		3	2	
2	1		3	
3		2		1
	2	1		3
	3		1	2

13

3		2		1
1	2		3	
2		1		3
	3		1	2
	1	3	2	

18

1			3	2
2		3	1	
	2	1		3
	3		2	1
3	1	2		

14

3	1	2		
2			1	3
1		3	2	
	2		3	1
	3	1		2

19

		1	2	3
1	2		3	
	3	2	1	
2		3		1
3	1			2

15

2	3	1		
	2		1	3
1		3		2
	1	2	3	
3			2	1

20

2		3		1
3	2		1	
	3	1	2	
	1		3	2
1		2		3

1

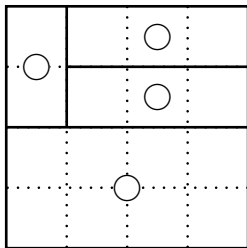

2

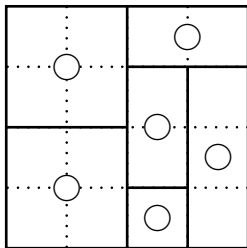

3

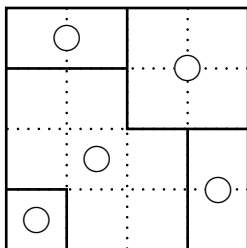

4

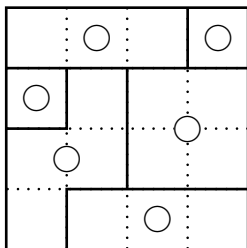

5

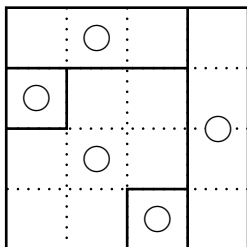

6

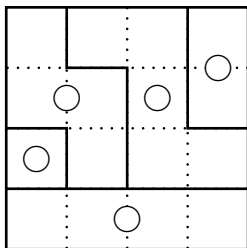

7

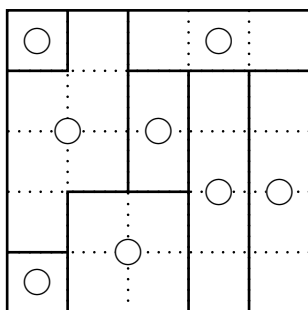

8

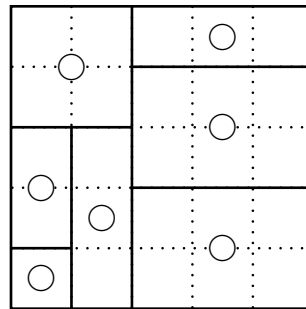

9

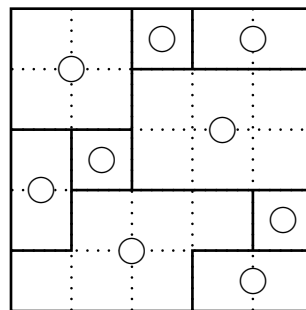

10

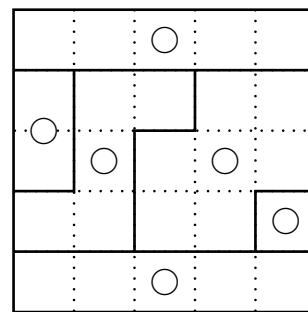

11

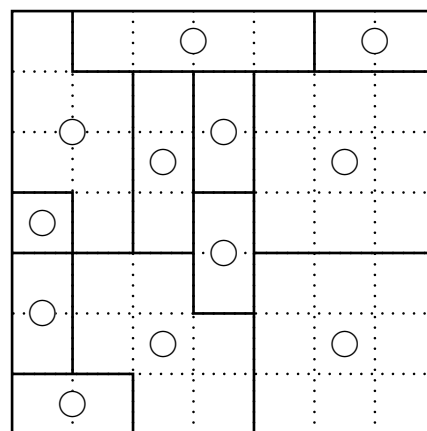

12

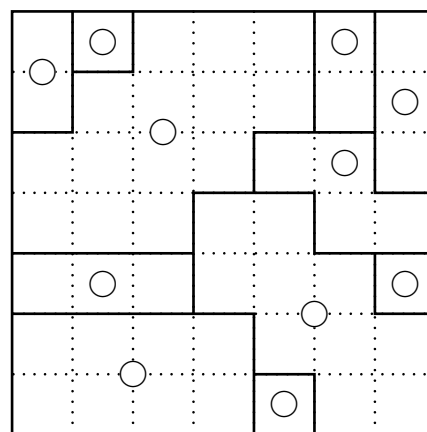



13

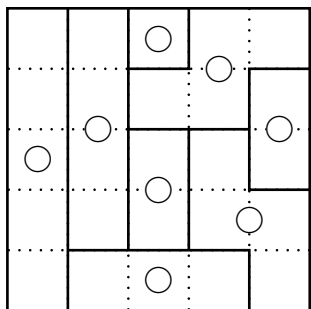

14

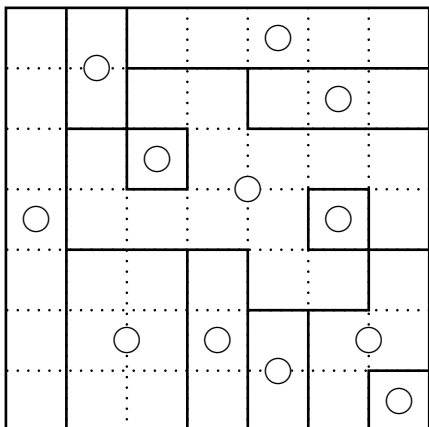

15

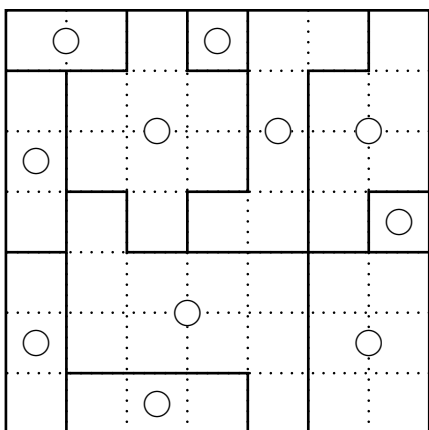

16

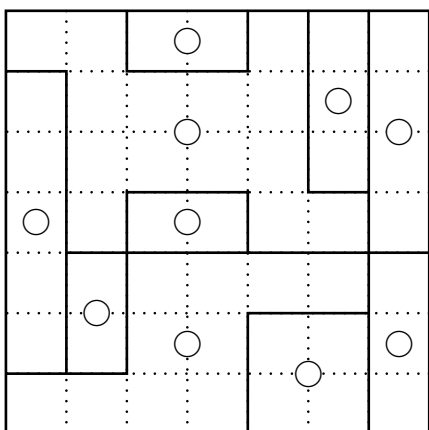

17

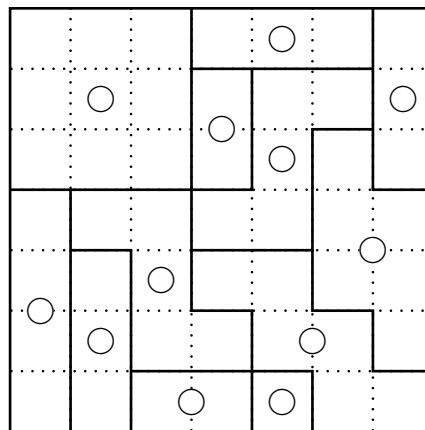

18

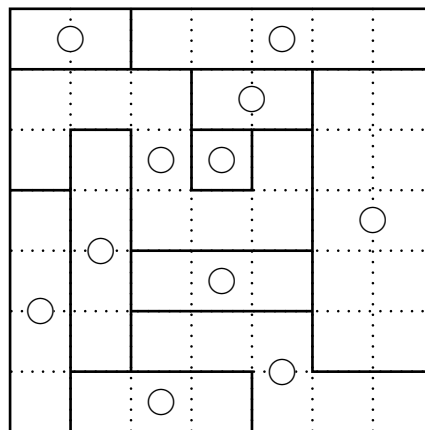

19

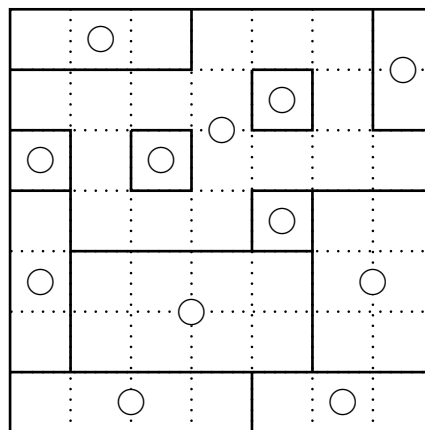

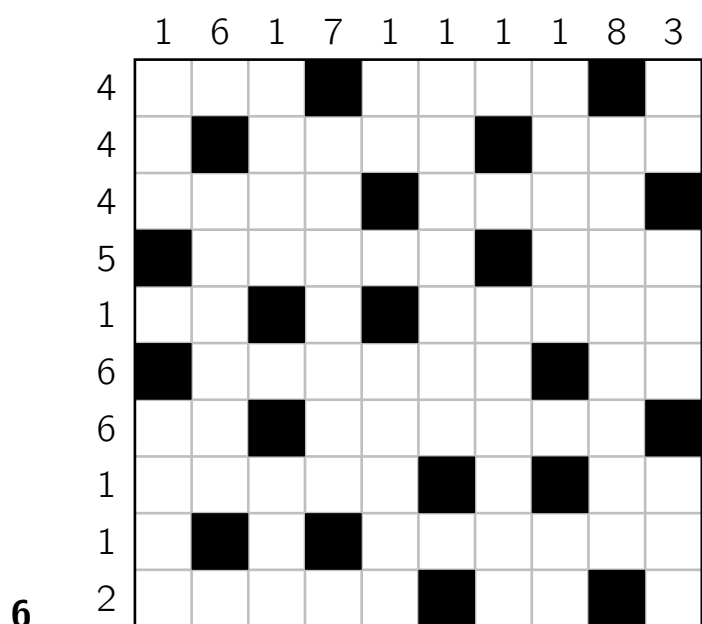
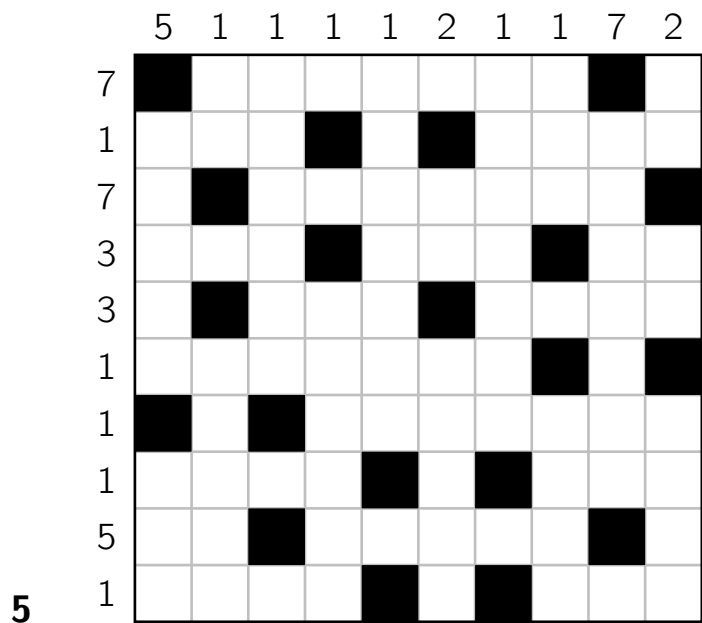
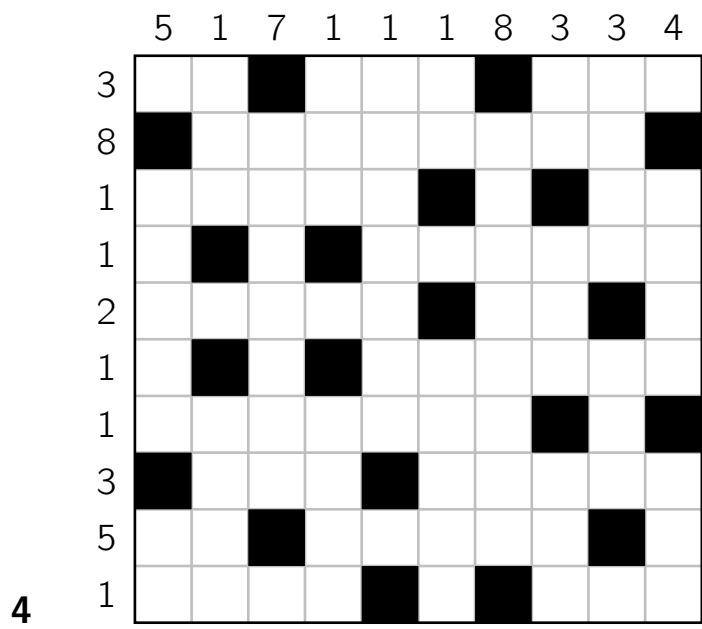
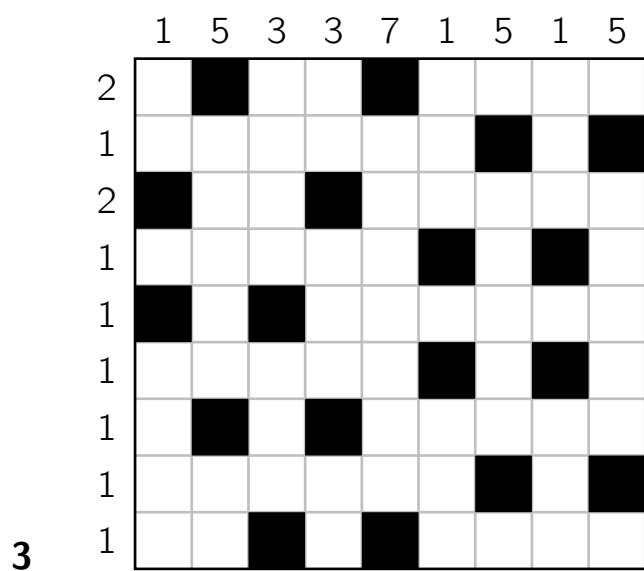
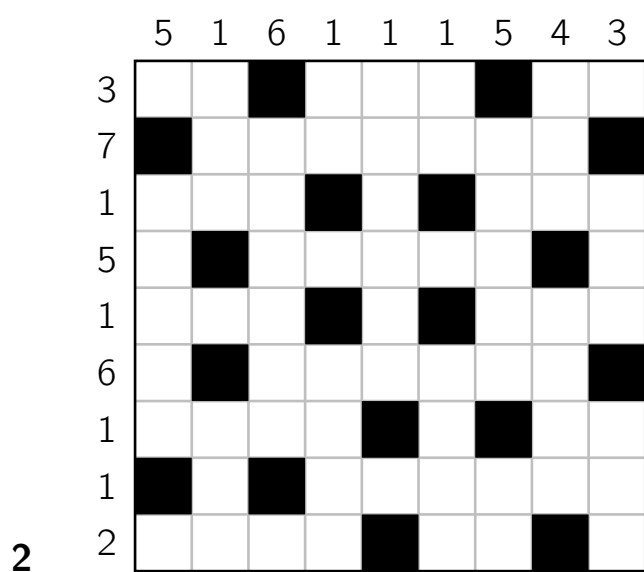
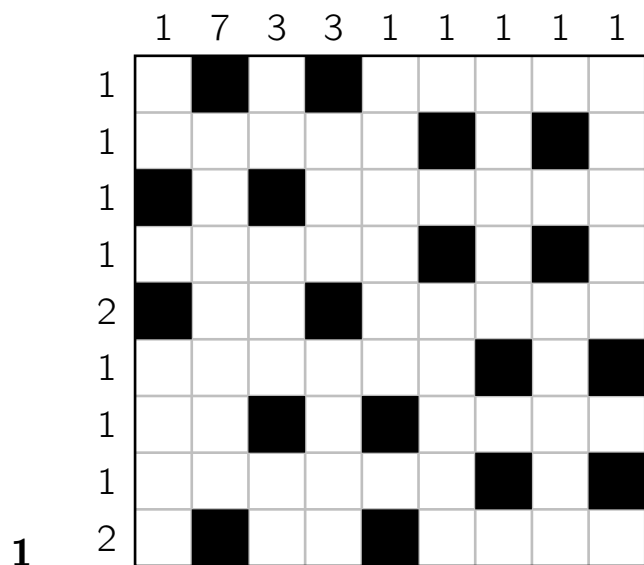

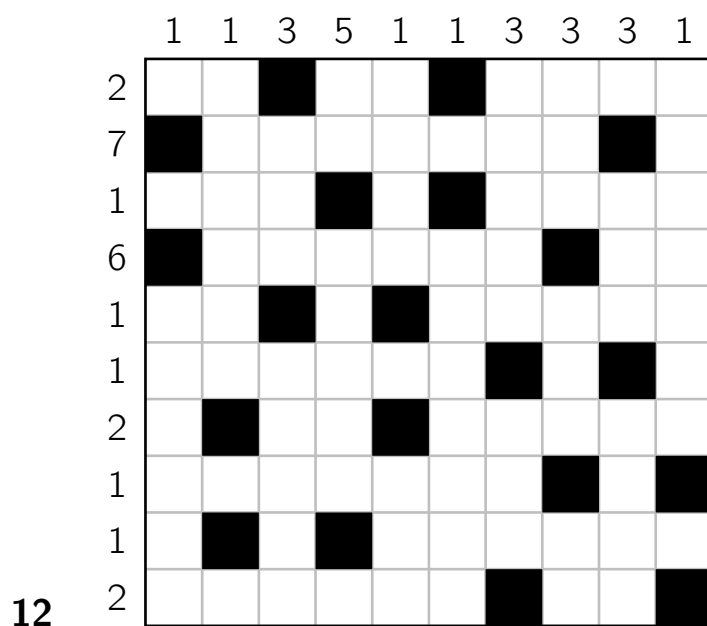
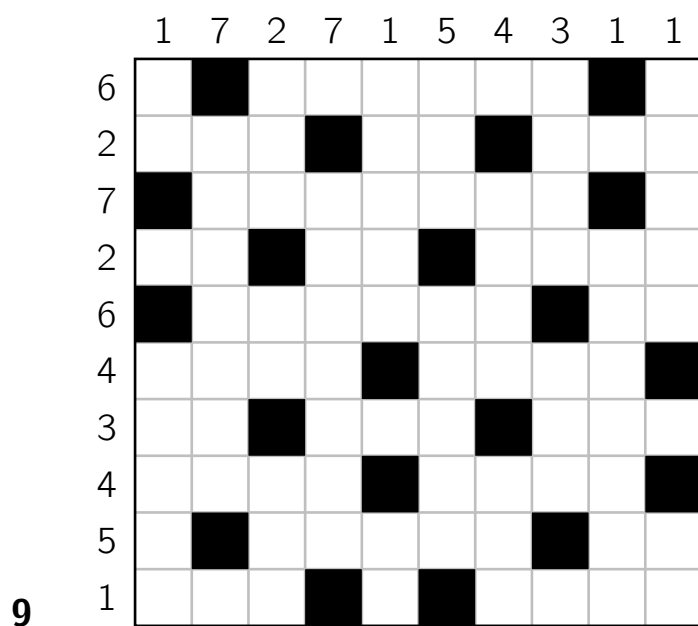
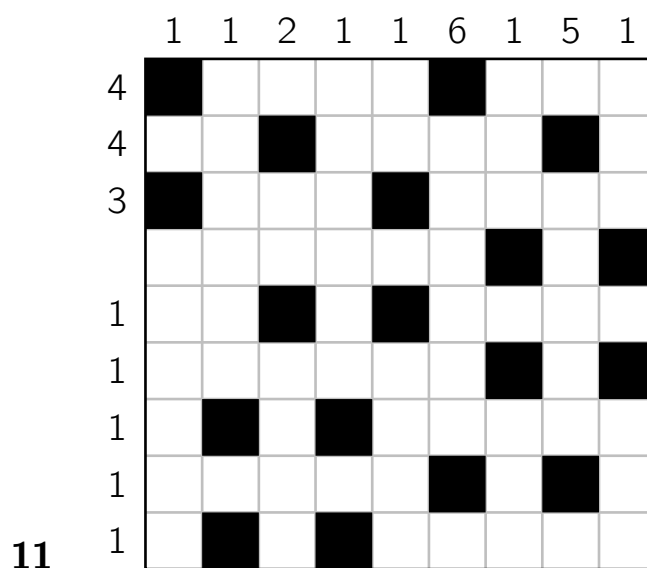
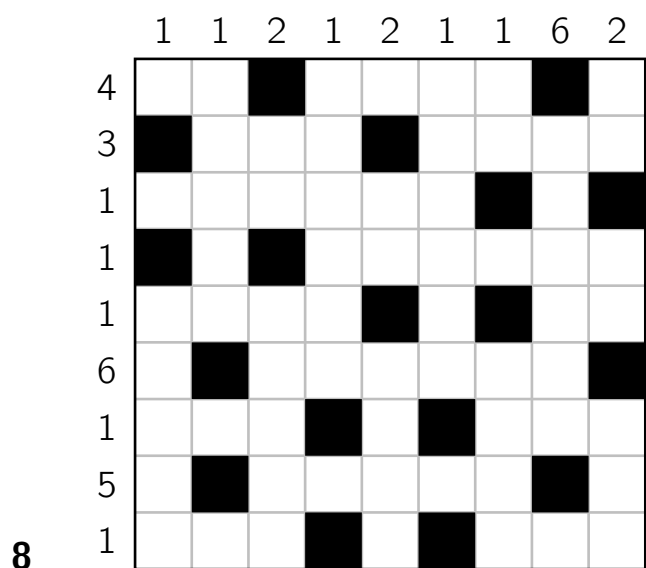
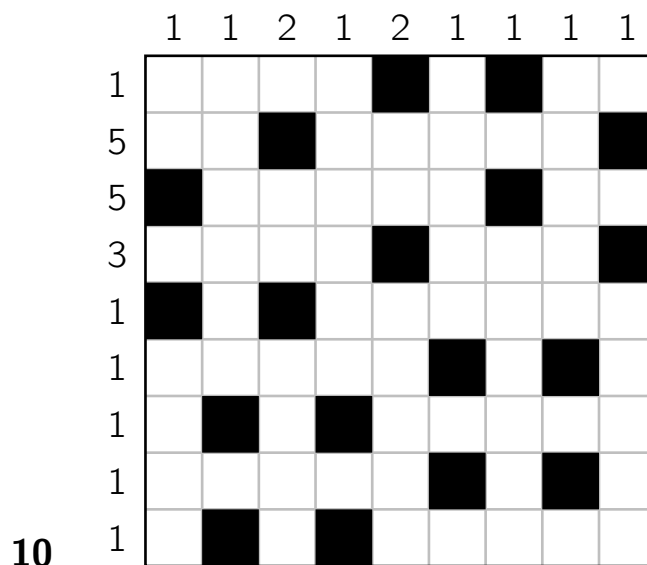
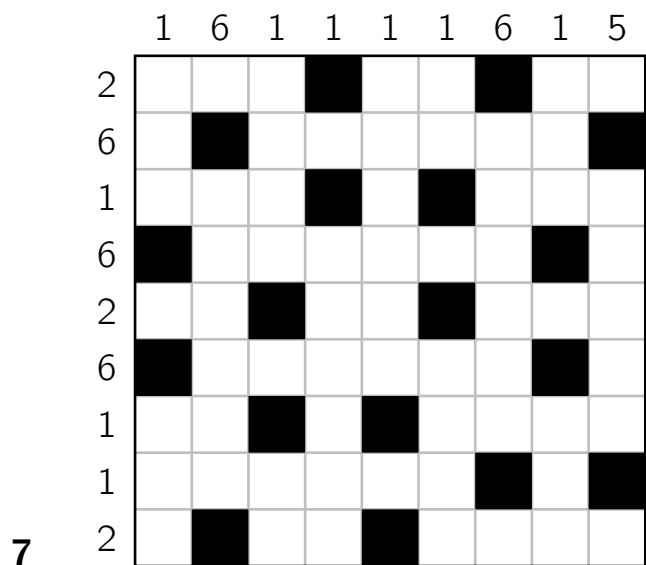

	1	1	1	2	1	2	
2				1		6	7
1		9					9
1					8		8
1			1				1
1	3						3
2				1		2	3
	3	9	1	2	8	8	

1

	2	1	1	2	1	2	
2	9				9		18
1			4				4
2	5					6	11
1				7			7
1		8					8
2				3		2	5
	14	8	4	10	9	8	

5

	1	2	1	1	0	3	
2				3		1	4
1		7					7
1						2	2
1		5					5
1						2	2
2	6		8				14
	6	12	8	3	0	5	

2

	1	0	2	1	2	1	
2			9		6		15
0							0
1				5			5
1						5	5
1			4				4
2	1				9		10
	1	0	13	5	15	5	

6

	2	1	1	1	1	2	
2		4				8	12
1				7			7
1	2						2
1					9		9
2	1		9				10
1						5	5
	3	4	9	7	9	13	

3

	1	1	2	1	2	1	
1			9				9
1					3		2
2	9		6				15
1					1		1
1		9					9
2				7		4	11
	9	9	15	7	3	4	

7

	2	1	1	1	1	1	
1				9			9
2		8				5	13
3	8		6		9		23
1	1						1
	9	8	6	9	9	5	

4

8

	2	1	1	1	1	2	
1						8	8
2		2		4			6
1						3	3
2	6		3				9
1					2		2
1	8						8
	14	2	3	4	2	11	

9

	2	1	1	1	2	1	
1					8		8
1		2					2
2				3		9	12
1	9						9
1			6				6
2	2				3		5
	11	2	6	3	11	9	

10

	2	1	1	2	2	1	2	1	
1					3				3
2		6					6		12
1					6				6
2			9				5		14
1	1								1
3				7		3		7	17
1	5								5
1				8					8
	6	6	9	15	9	3	11	7	

11

	1	1	1	1	3	1	3	1	
2			2		4				6
2	5						3		8
1					4				4
1							1		1
1					9				9
1							6		6
1		5							5
3				2		6		4	12
	5	5	2	2	17	6	10	4	

12

	1	2	1	1	2	0	1	3	
							7		7
1		3			2				5
2								9	9
1		2							2
1					9				9
2			2					4	6
1	4								4
2				1				2	3
	4	5	2	1	11	0	7	15	

13

	1	2	1	2	0	3	1	1	
1							2		2
2		7		7					14
2						1		3	4
1				8					8
2		1				5			6
0									0
2	8		1						9
1						6			6
	8	8	1	15	0	12	2	3	

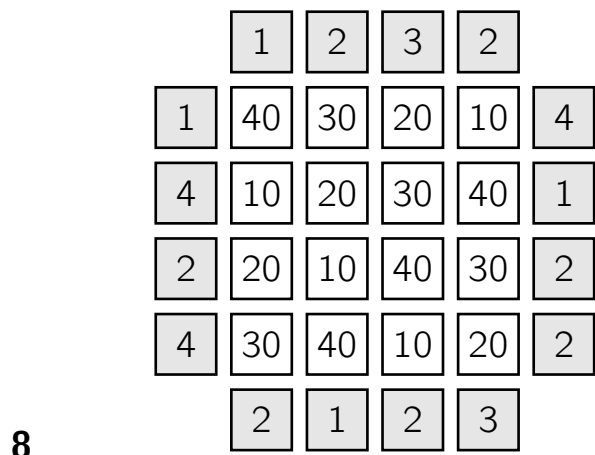
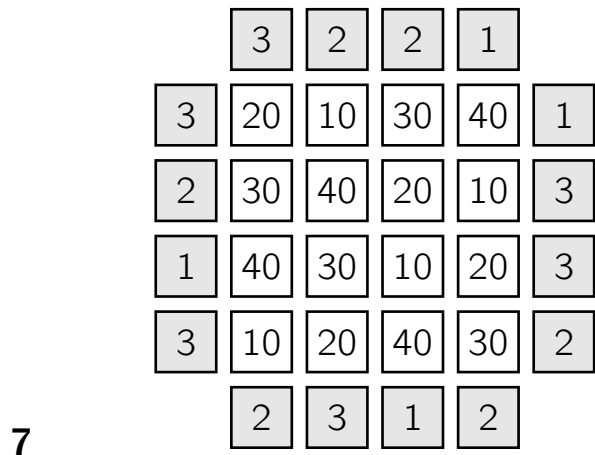
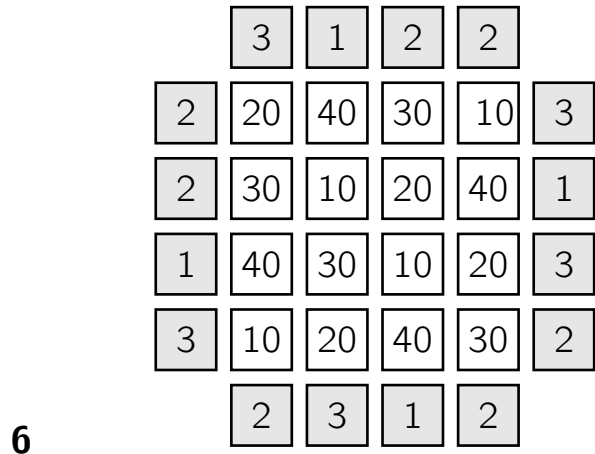
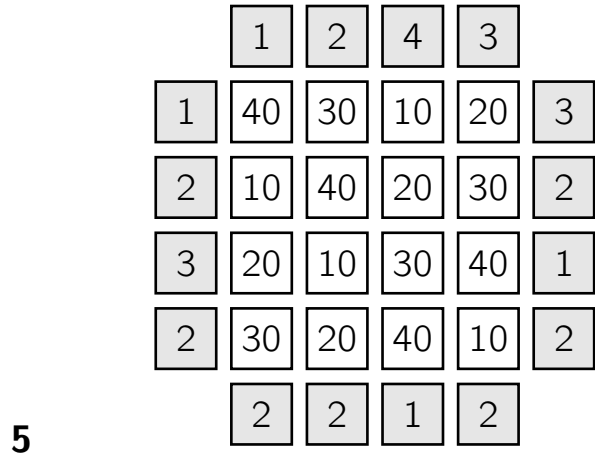
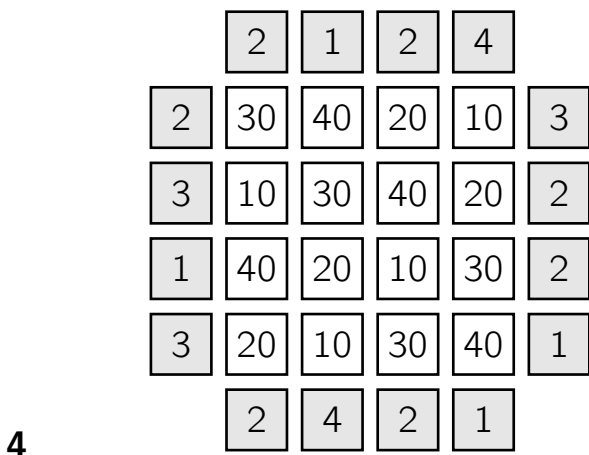
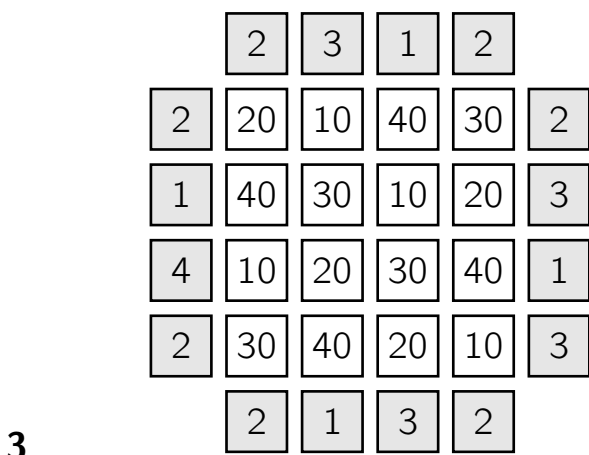
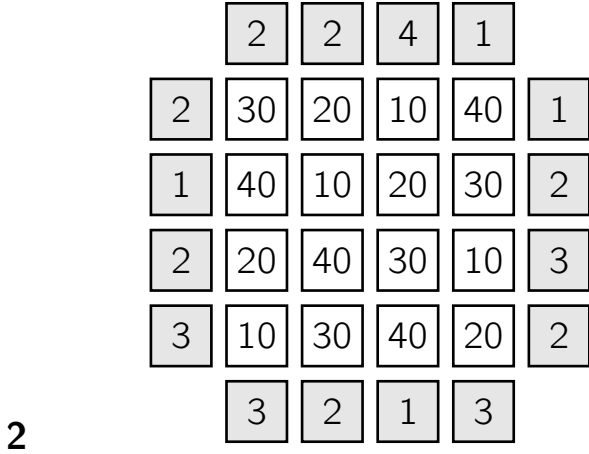
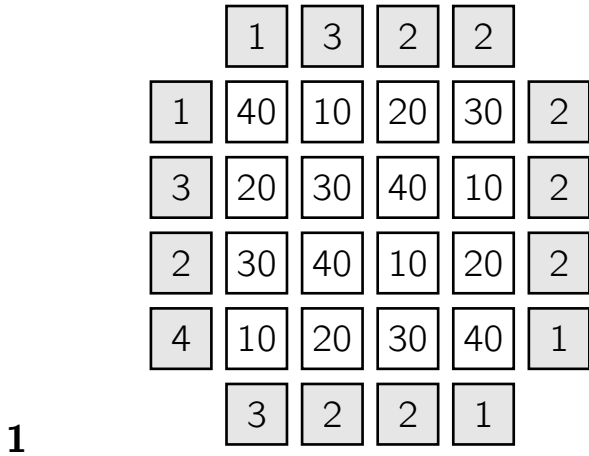

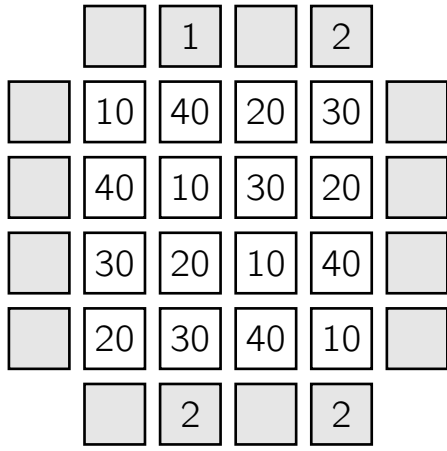

9

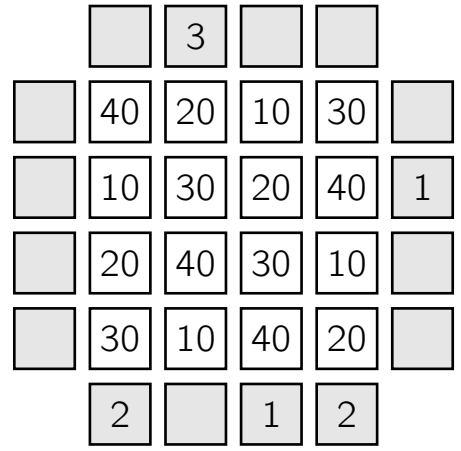

13

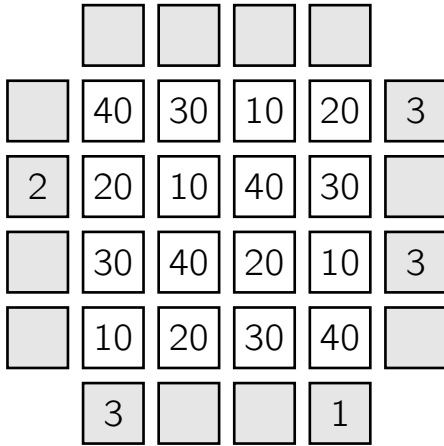

10

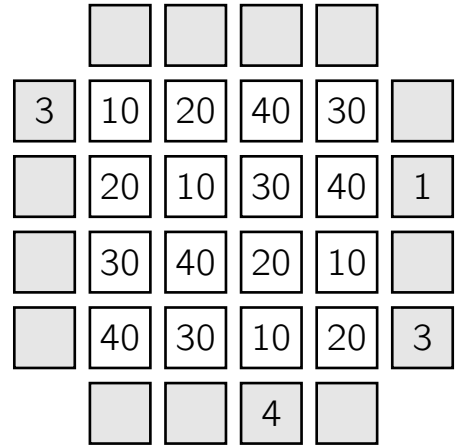

14

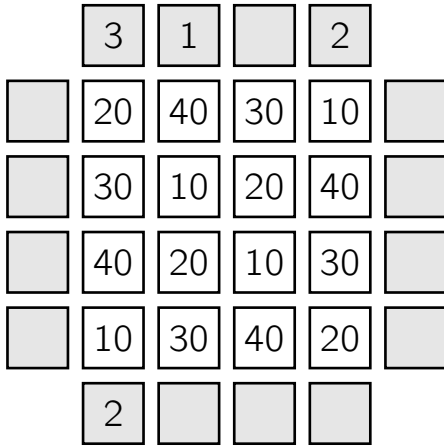

11

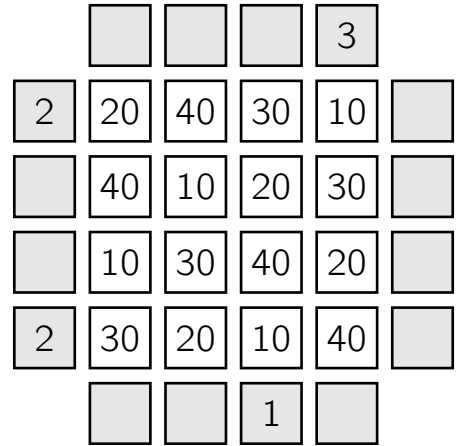

15

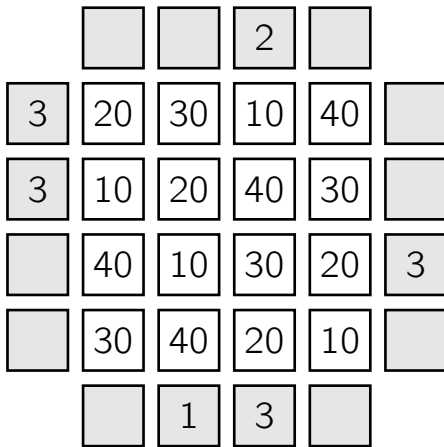

12

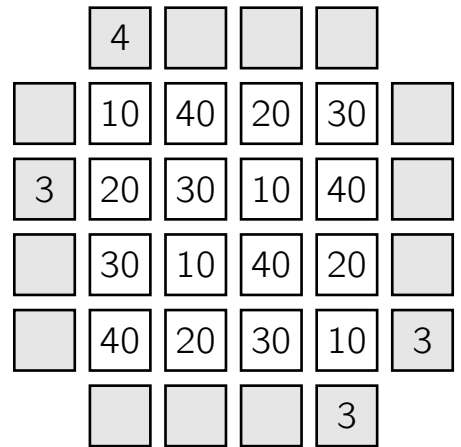

16

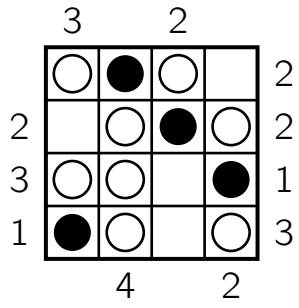

1

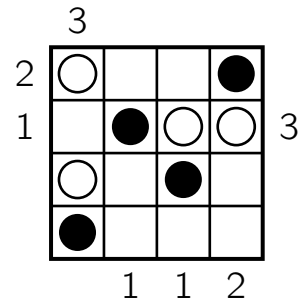

5

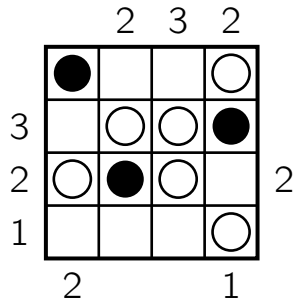

2

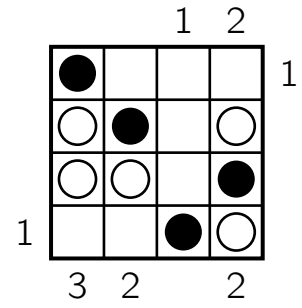

6

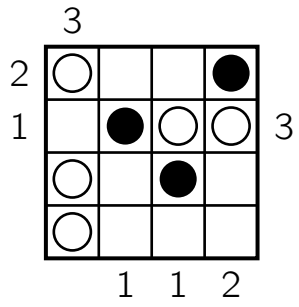

3

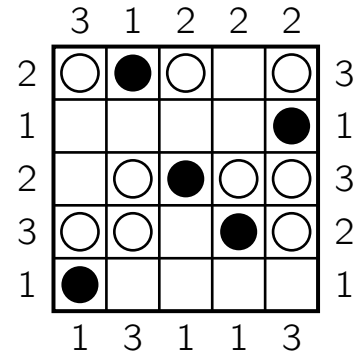

7

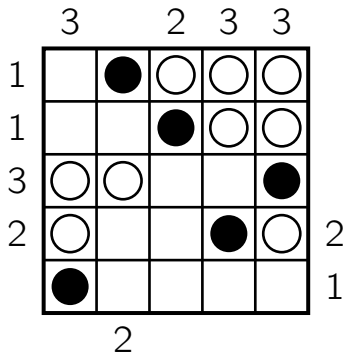

4

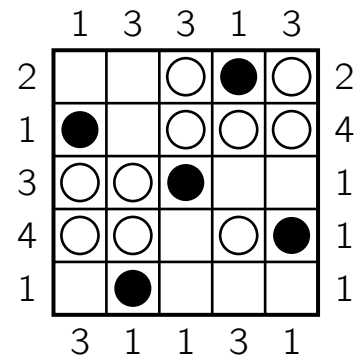

8



9

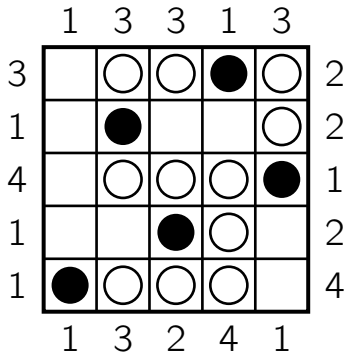

13

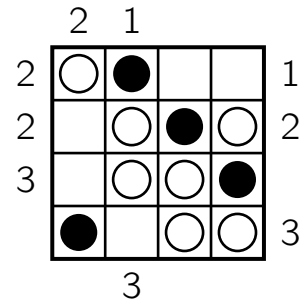

10

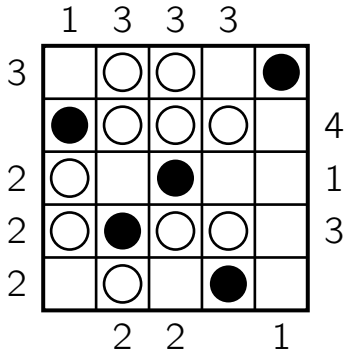

14

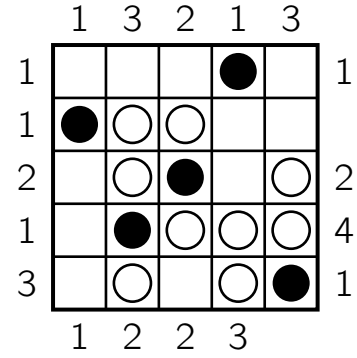

11

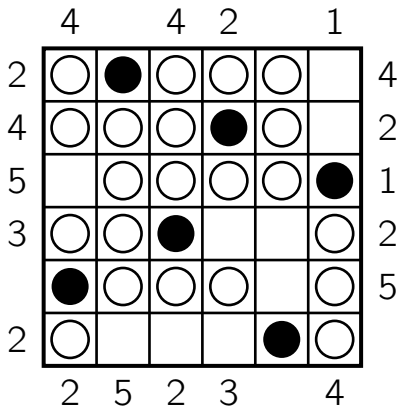

15

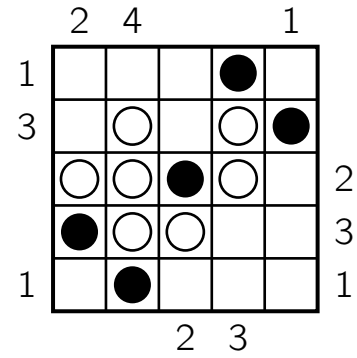

12

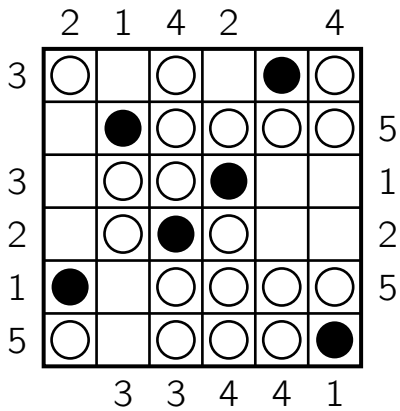

16

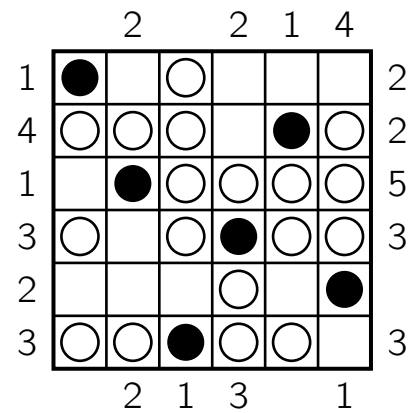

1

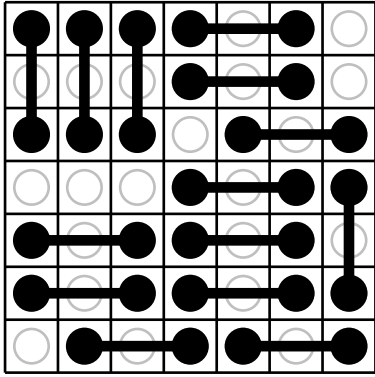

2

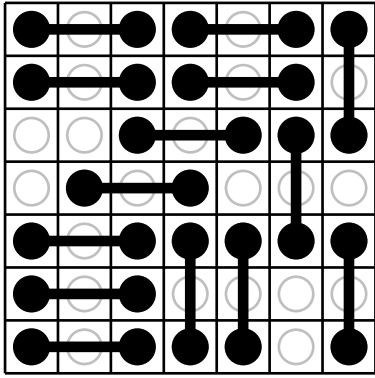

3

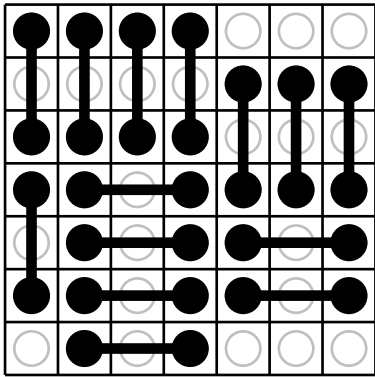

4

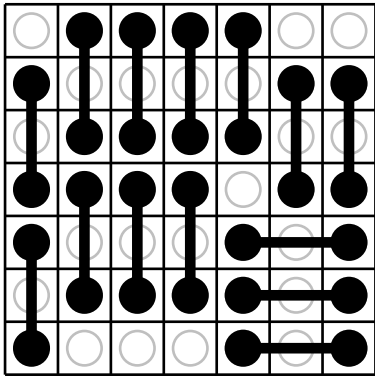

5

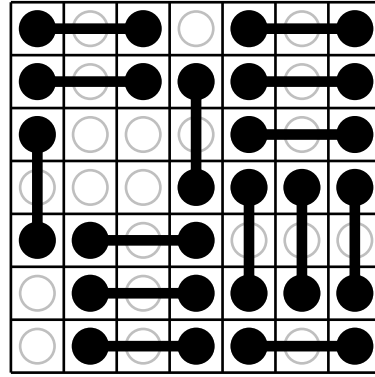

6

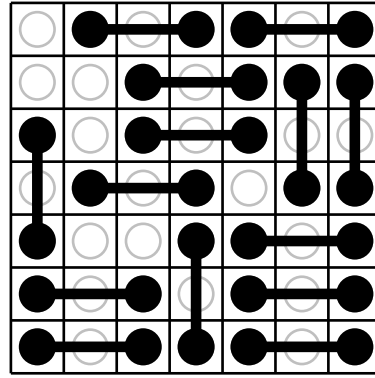

7

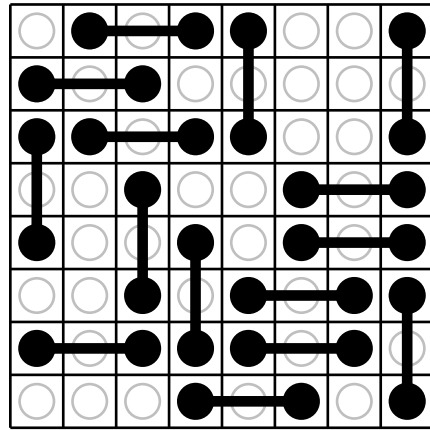

8

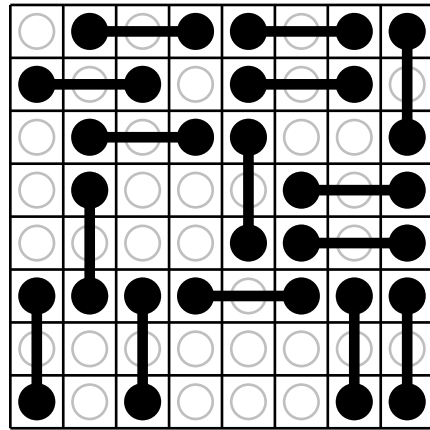



1

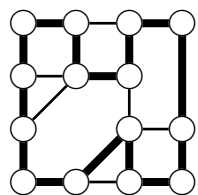

2

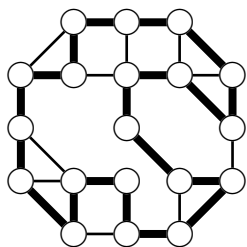

3

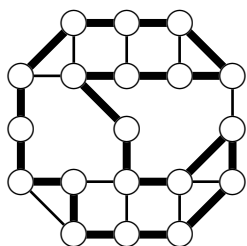

4

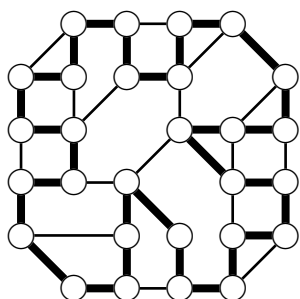

5

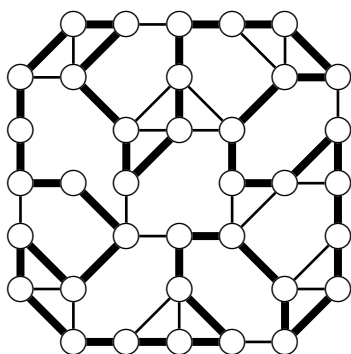

6

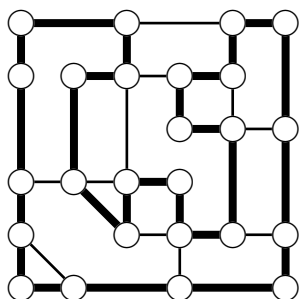

7

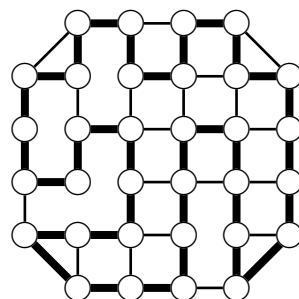

8

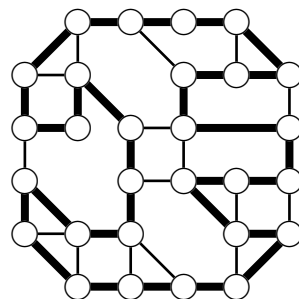

9

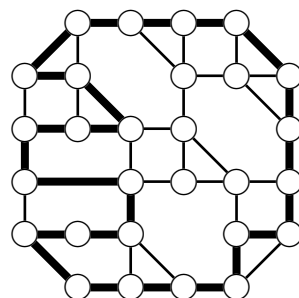

10

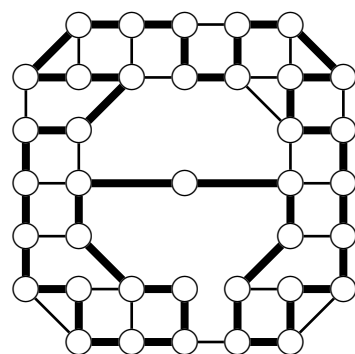

11

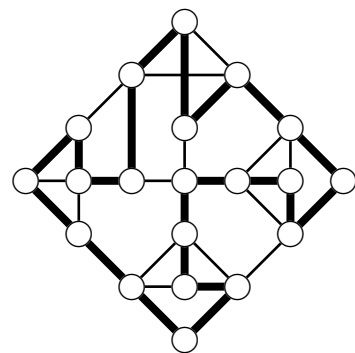

12

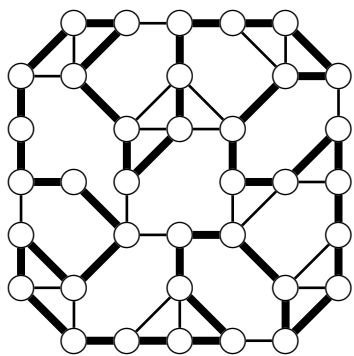

13

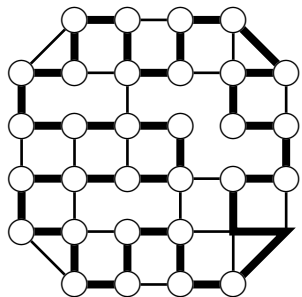

14

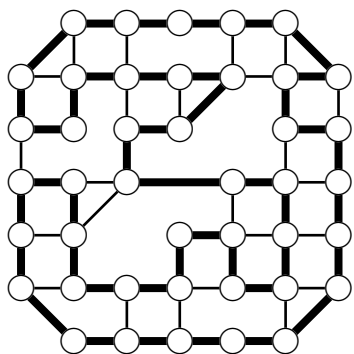

15

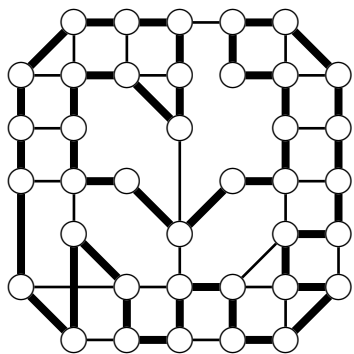

16

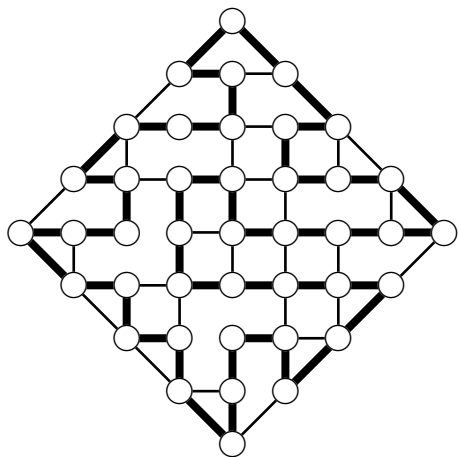

17

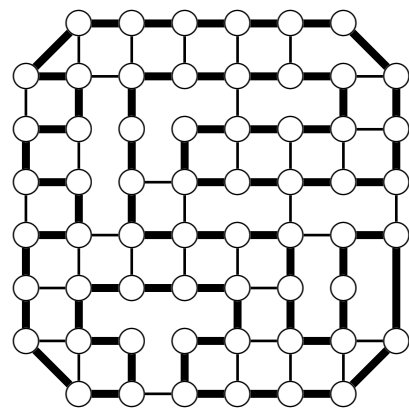

18

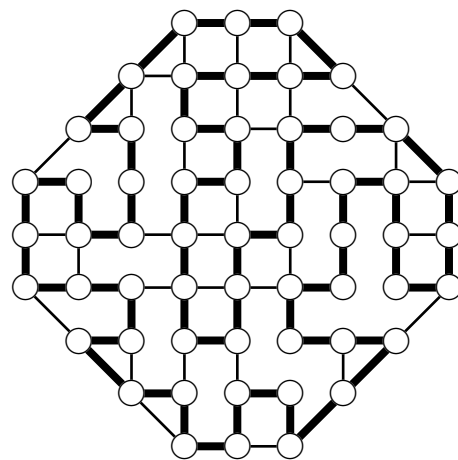

1

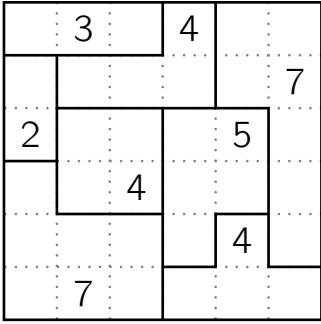

2

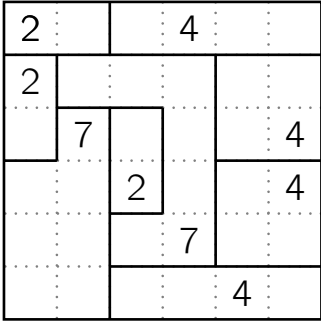

3

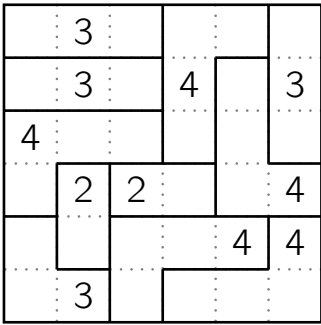

4

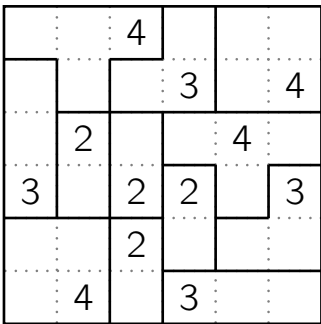

5

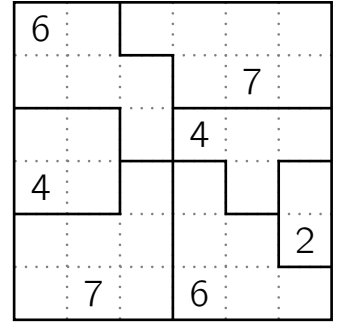

6

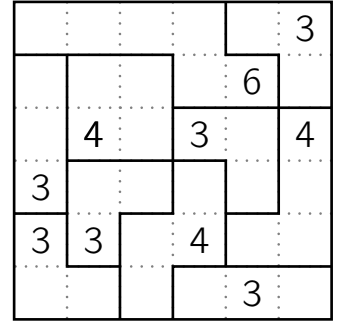

7

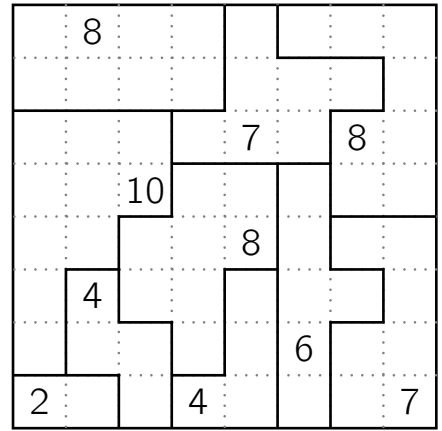

8

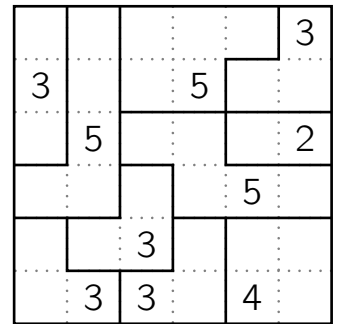

9

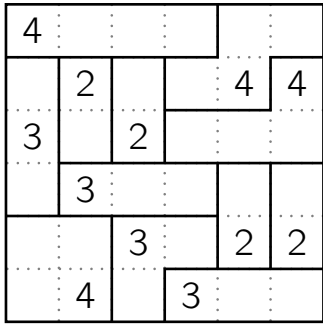

10

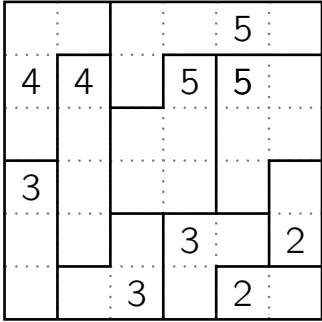

11

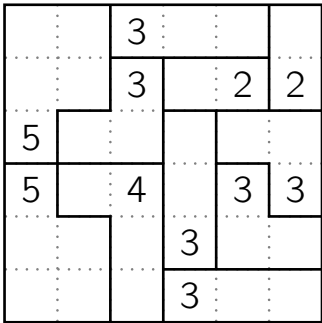

12

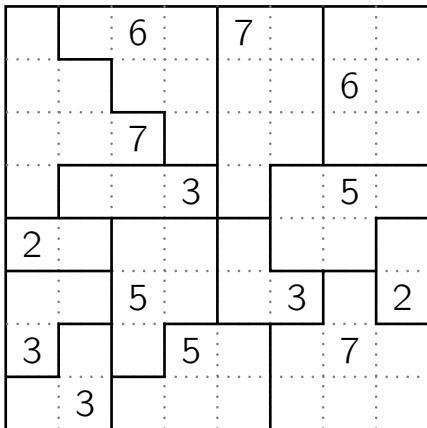

13

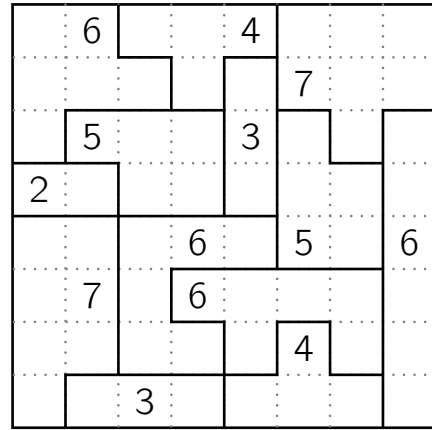

14

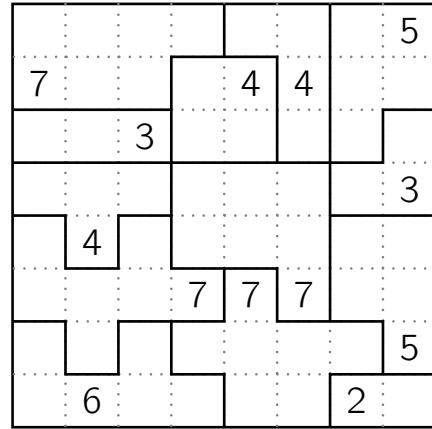

15

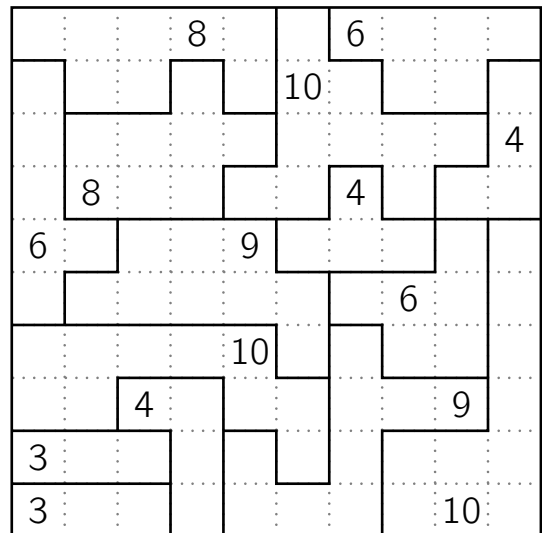

1

10	11	12	13	17	15
9	8	7	18	14	16
35	36	19	6	5	4
34	33	26	20	21	3
32	27	28	25	22	2
31	30	29	24	23	1

2

32	31	30	36	2	3
33	34	35	29	4	1
22	23	25	28	5	6
20	21	24	26	27	7
19	17	14	13	9	8
18	15	16	12	11	10

3

2	1	12	13	14	15
3	11	24	23	16	17
10	4	25	22	18	19
9	5	26	27	21	20
6	8	36	28	32	31
7	35	34	33	29	30

4

2	3	4	5	6	7
1	33	31	30	29	8
35	34	32	28	27	9
36	23	22	25	26	10
20	21	24	15	13	11
19	18	17	16	14	12

5

25	26	27	28	36	35
23	24	29	33	34	1
22	21	30	31	32	2
20	19	12	11	10	3
18	14	13	9	6	4
17	16	15	8	7	5

6

21	20	19	3	5	6
22	18	2	16	4	7
23	1	17	35	15	8
24	25	34	14	36	9
26	29	30	33	13	10
27	28	31	32	12	11

7

17	20	19	22	23	24
16	18	21	30	27	25
15	14	29	28	31	26
13	8	7	6	32	1
12	9	34	33	5	2
11	10	35	36	3	4

8

5	3	7	9	12	11
4	6	2	8	10	13
29	27	31	1	14	16
28	30	26	32	17	15
22	24	25	18	33	36
23	21	20	19	35	34

9

1	2	3	4	23	22
29	28	6	5	24	24
30	27	7	25	20	19
31	8	26	10	16	18
36	32	9	11	15	17
35	34	33	12	13	14

10

19	21	22	23	5	4
20	18	7	6	24	3
17	8	10	25	2	1
16	11	9	26	33	32
15	12	27	30	31	34
13	14	28	29	35	36



11

4	3	33	34	27	26
2	5	35	32	25	28
6	1	36	24	31	29
7	15	16	22	23	30
8	11	14	17	21	19
10	9	12	13	18	20

16

5	4	14	13	16	17
6	3	8	15	12	18
32	7	2	9	19	11
31	33	27	1	10	20
30	28	24	26	23	21
29	36	35	24	25	22

12

5	3	7	1	9	19
4	6	2	8	11	35
24	26	27	12	36	34
25	23	13	28	32	33
22	20	18	14	29	31
21	19	17	16	15	30

13

25	24	36	35	34	33
23	26	27	28	32	30
7	22	21	20	29	31
6	8	19	18	16	14
4	5	9	17	15	13
3	2	1	10	11	12

14

25	27	29	30	31	35
26	24	28	32	34	36
19	21	23	33	14	13
20	18	22	16	15	12
3	1	17	8	9	11
2	4	5	6	7	10

15

31	23	24	25	1	2
32	30	22	26	4	3
33	21	29	27	11	5
34	20	28	12	6	10
35	19	13	16	7	9
36	18	17	14	15	8

1

	3		5	1
3	4	1	2	
1		5	4	3
	1	2		4
4	5	3	1	

2

2		1		4
3	1	4	5	2
	3		2	
5	2	3	4	1
	5		1	

3

2		5	4	
4	1		5	2
	5	2		4
5	2	4	1	3
	4		2	

4

2	4		1	
	5	4	2	1
4	3		5	2
5	1	2	3	
	2		4	3

5

	5		4	3
3	4	5	1	
5		1		4
2	1	4	3	5
4		3		1

6

3	5	2	1	
	2		3	5
2	1	5		3
4	3		5	2
5		3	2	

7

2	3	1		6	
	2		3	5	6
4	5	3	6		2
	1	6		2	
6	4	5	2	3	1
3		2		4	

8

	2		5	1	
5	1	3	6		4
	5		1	3	2
2		5		6	1
1	4	2	3	5	
3		1		4	5

9

	5	3		2	4
4	6		2		5
	3	2	4	1	6
1		4		6	
3	1	5	6	4	2
	4		3	5	

10

	6	2	3	1	5
6		1		5	
2	3	6	5	4	1
	1		4		2
3	5	4	1	2	6
1		5		3	

11

5		3	1	
2	5	1		3
	1		2	5
1	4	5	3	2
	3	2		1

12

5	3	4		1
	1	3	4	5
3	5		1	
1		5	3	2
	2	1	5	

13

2		1	4	
3	2		5	1
	3	5		4
5	4	3	1	2
	1		3	

14

3	1		2	4
5		4	3	
2	3		4	5
4	5	3	1	2
1		2		3

15

	5		4	3
3	4	5	1	
5		1		4
2	1	4	3	5
4		3		1

16

	1	4		5
4	5		1	3
2		1	5	4
1	4	5		2
5		3	4	

17

6	1		2	5	
2		3	1		6
4	3	2	5	6	4
	4		3	2	
5	6	1		3	2
3		5	6		4

18

	6	1		3	
3	5		1	6	4
	3	4	6		2
2		3	4	5	
6	2		3	4	1
	4	6	5		3

19

1	6	2	4		5
	2	1		5	4
5		4	3	6	
6	3	5		4	1
2		6	5		3
	5	3		2	6

20

1	5		2	4	3
	2	3		1	
6	1		3	2	5
3	4	2	6		1
	3	5		6	4
5	6	1	4		2

1

1	3	5	2
4	6	2	1
2	1	7	4
5	2	1	1

2

1	5	2	3
3	2	8	1
5	6	1	2
2	1	4	3

3

1	3	5	2
3	6	2	1
5	2	1	5
2	1	4	1

4

1	2	5	2
4	1	8	2
3	6	2	1
2	5	1	4

5

1	2	3	1
2	8	1	4
3	6	2	1
1	1	6	2

6

1	2	11	3
7	1	3	2
3	15	2	1
2	3	1	4

7

1	2	3	6	3
3	14	11	2	1
2	3	9	1	7
6	1	2	12	3
1	4	1	3	2

8

1	2	7	9	3
4	7	3	2	1
6	1	13	3	2
2	3	1	9	6
3	11	2	1	1

9

1	3	2	7	5
7	1	12	3	2
6	2	1	12	3
3	11	9	2	1
2	8	3	1	4

10

1	4	6	2	8	3
2	10	1	3	8	3
3	1	2	10	9	5
6	11	9	1	3	2
5	2	3	10	1	9
5	3	8	6	2	1

11

1	4	5	7	2	3
4	9	3	2	9	1
3	3	2	1	10	4
6	8	10	3	1	2
2	1	7	8	3	6
3	2	1	4	3	3

12

1	2	3	9	5
4	10	1	3	2
4	1	2	14	3
3	11	9	2	1
2	3	6	1	4

13

1	6	3	11	2
4	10	2	3	1
6	3	1	2	9
2	1	10	7	3
3	2	4	1	4

14

1	3	4	6	2
2	10	7	1	3
3	11	1	2	7
6	2	3	12	1
3	1	2	3	4

20

1	3	9	7	2
7	1	3	2	7
2	9	1	13	3
7	2	9	3	1
3	7	2	1	5

15

1	4	5	7	2	3
4	9	3	2	9	1
3	3	2	1	10	4
6	8	10	3	1	2
2	1	7	8	3	6
3	2	1	4	3	3

21

1	11	4	2	3
3	2	1	4	16
2	1	19	3	4
14	4	3	1	2
4	3	2	9	1

16

1	2	14		
9	1	4	3	2
2	3	1	20	4
4	22	3	2	1
3	4	2	1	4

17

1	7	6	3	2	2
3	1	2	10	11	6
6	11	10	2	1	3
4	2	3	10	10	1
2	11	1	8	3	6
5	3	5	1	6	2

18

1	3	7	6	2	4
6	7	1	3	11	2
2	6	8	1	3	8
5	1	2	10	8	3
6	2	3	8	1	5
3	8	7	2	4	1

19

1	3	6	5	2
3	13	2	1	5
6	1	3	2	7
5	2	12	3	1
2	5	1	8	3

1

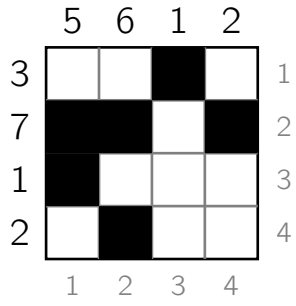

5

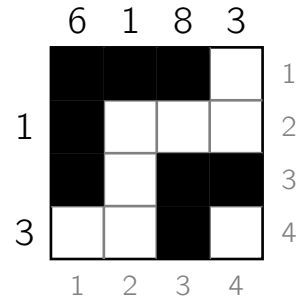

2

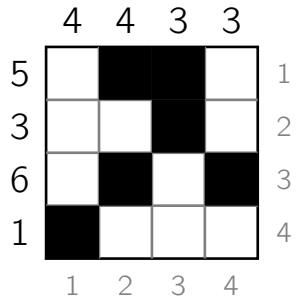

6

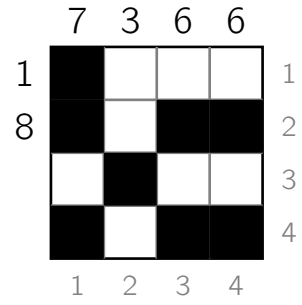

3

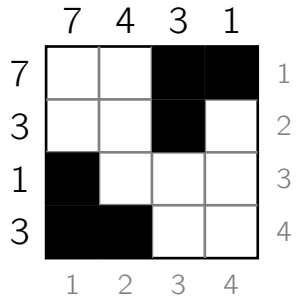

7

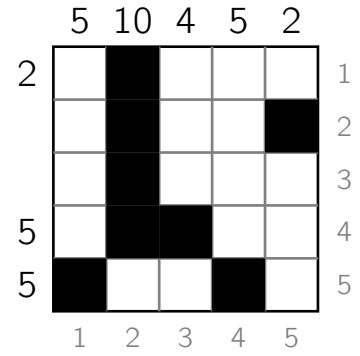

4

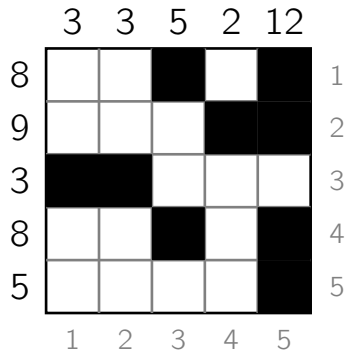

8

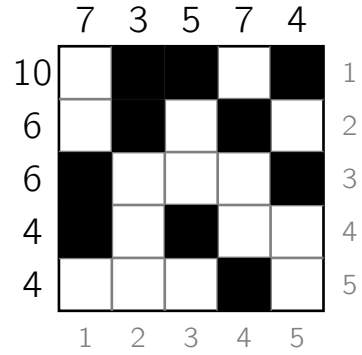

9

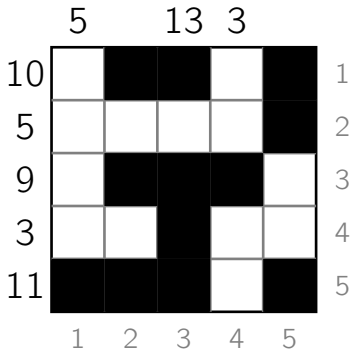

13

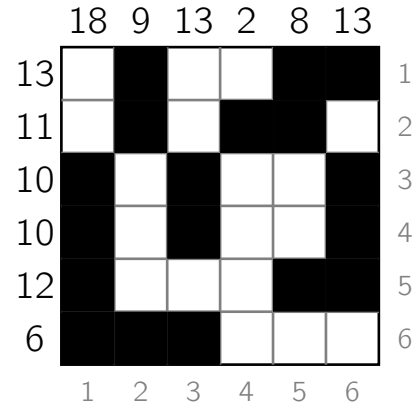

10

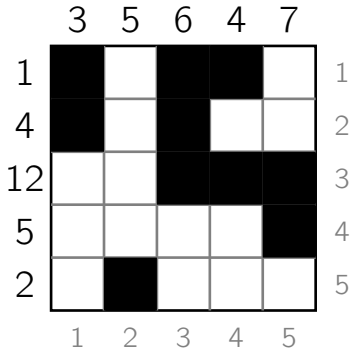

14

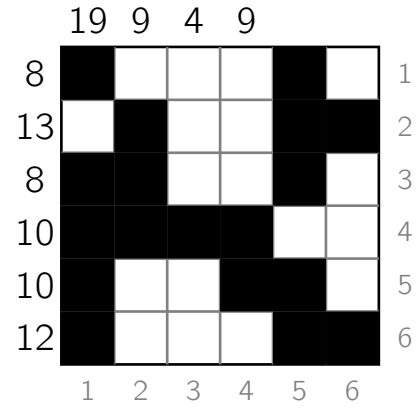

11

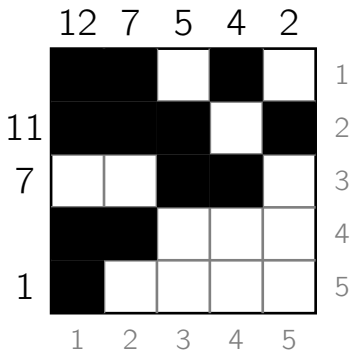

15

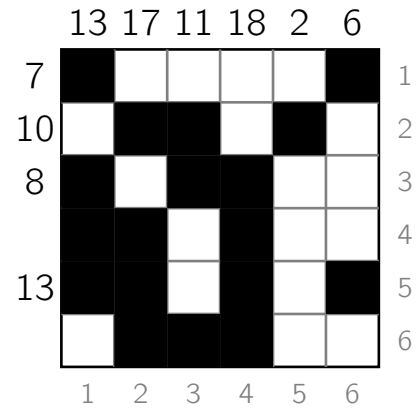

12

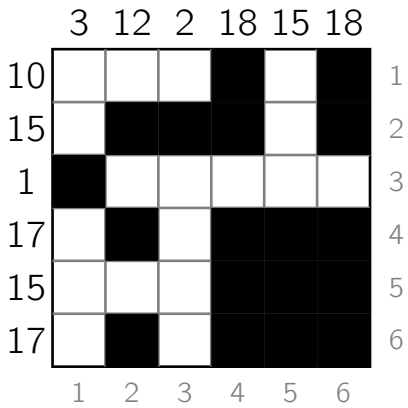

1

				8	6
		8	6		
8	6		8		
8		8	6		4
6				4	6
	6			6	

2

	4				8
			14	4	
	4	14			4
			4	10	
		4	12		8

3

6	8				6
	8				10
12		10			4
4					
		4		4	
				12	10

4

				8	6
			14	6	
6	14				4
10					
6			6		10
					6

5

12	12	10			4
		4			
					6
		6			4
4		6	12	10	
				6	

6

		10	4		6
			12		
	8	4		14	
	10			4	
	8	12			

7

	6	8					
		8		6		8	6
			6	8			6
	4	8	8	4			6
10	6						8
	6		4		8		
8	4						8
		8	6		6		8

8

4		10	8			10	6
		8					
			4				6
	6		8				6
	6			8		8	8
10		8			6	8	
	8		8				
	8	4		4		8	

9

	8	6			
12		6			
				8	8
	4	8		8	4
	6		6		
				12	



10

	6	8	4			6	
			6		4	6	
		6		8	8		10
4	10		4	12			
8		6			10		
10		6					
	6		4	6		6	
				8	8		

14

8							8
					10		
		6	6		6		
	10		8				
		8	6	10			4
10	8			6	8		
		6	4				

11

			8	6				8	6
6		4		6		6		6	
8				8	6	8		6	
6	8			8		6			4
				6	4		4	8	
6		6		4		6		6	4
6		6			6			8	
8			8	8			8		
4							6	6	6
	8	6	6		4		6		6

15

		10					6	
8	8				8			8
		6						4
		4		4	8	6		
			8	10		8		
8		4	6			8	10	
8	10							
						8		6

12

					4
	8				10
4				12	4
	4	10			
	8	8			8
6			6	6	

13

	8	12			
		6		14	
	10		4		
6					6
	6	12	4		
			6		

1

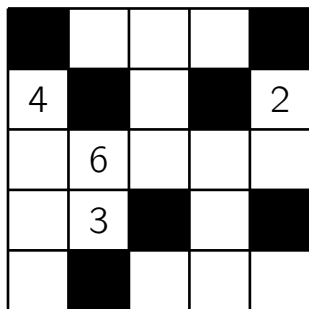

2

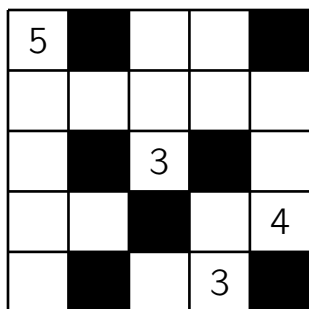

3

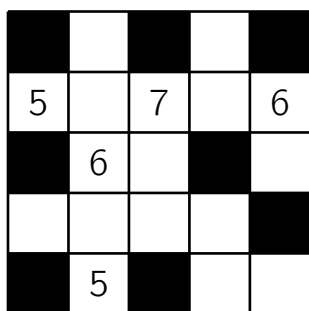

4

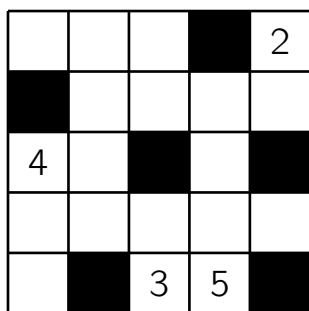

5

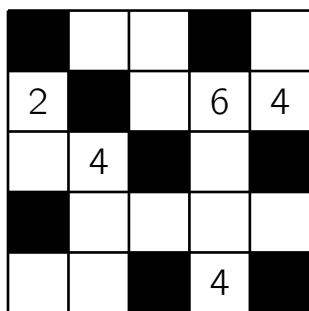

6

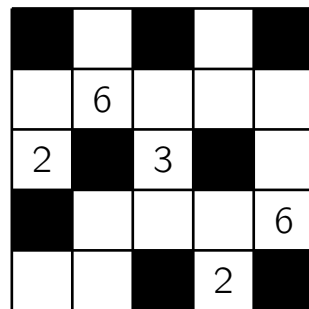

7

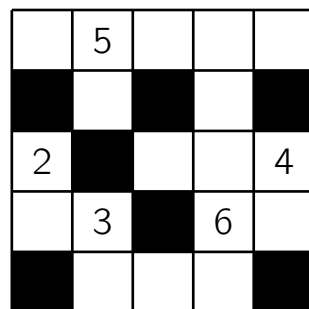

8

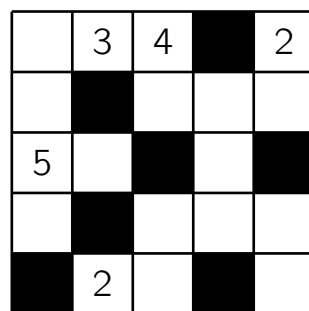

9

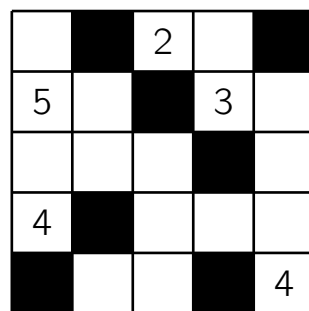

10

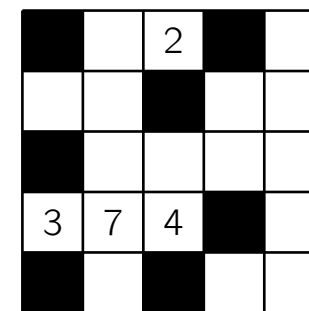

11

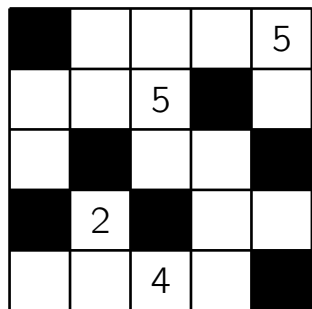

12

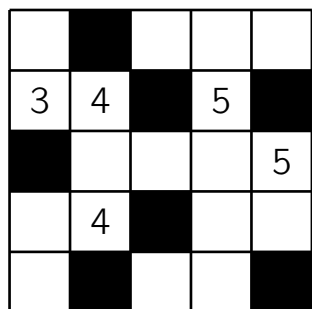

13

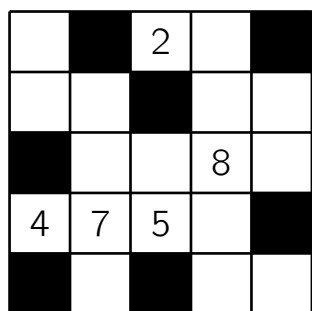

14

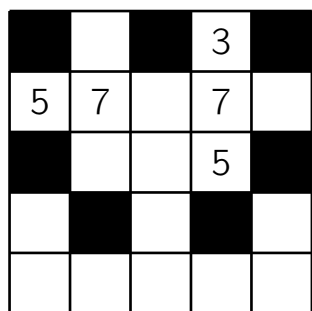

15

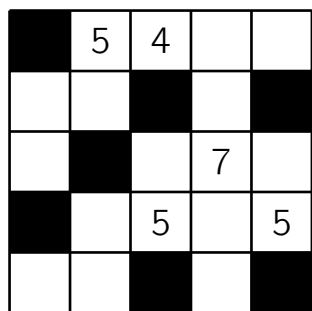

16

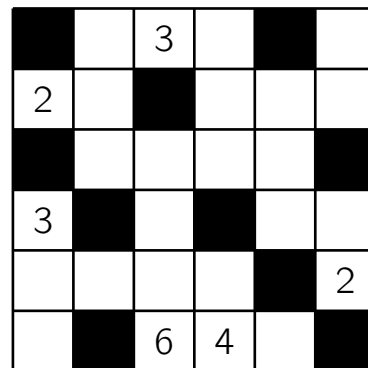

17

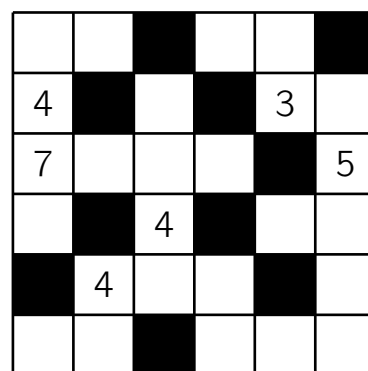

18

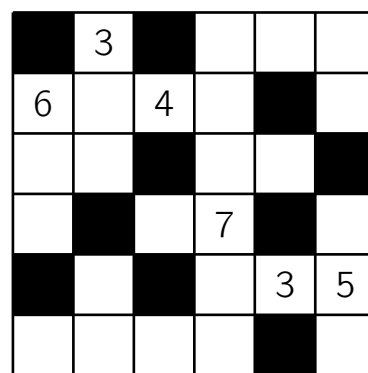

19

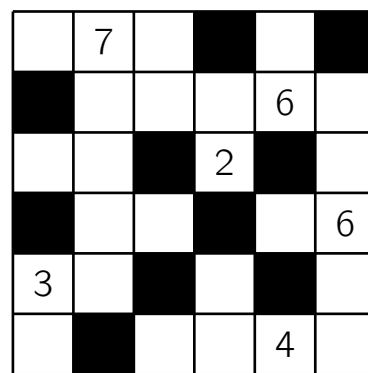

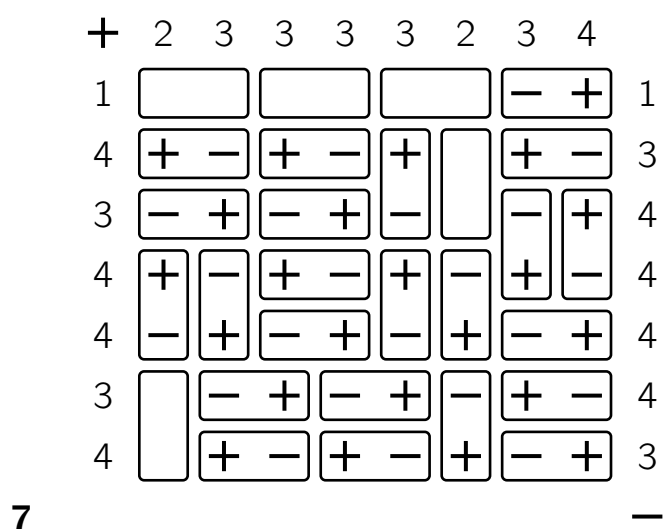
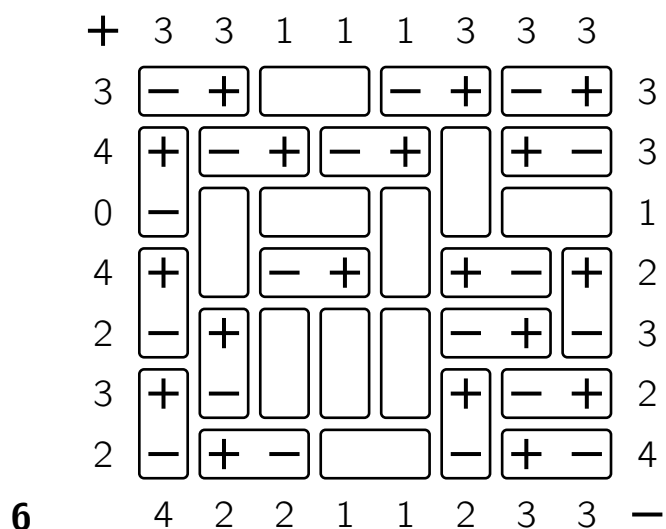
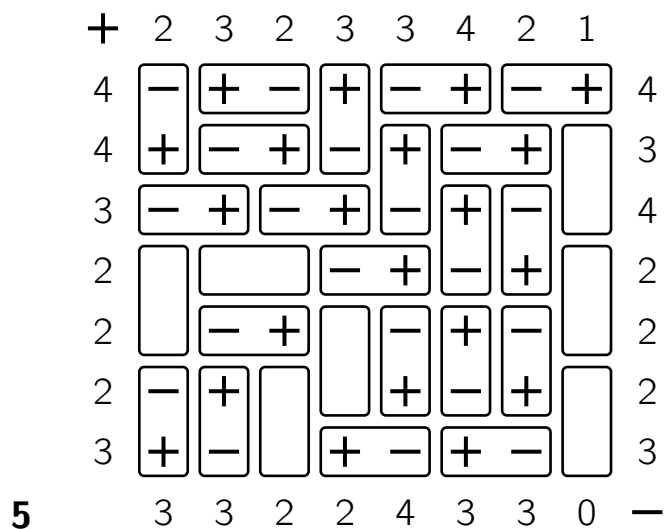
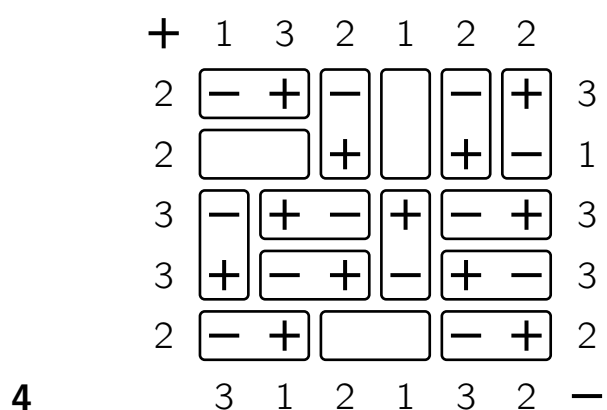
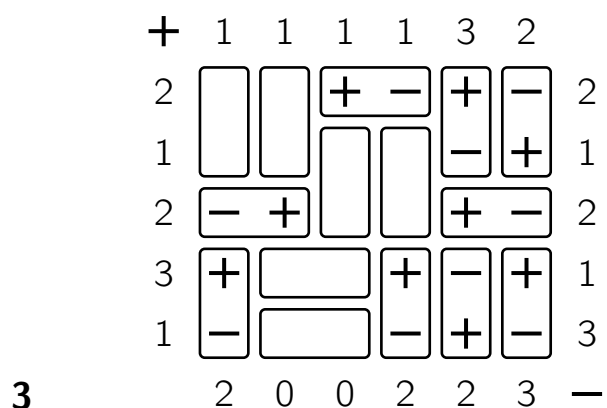
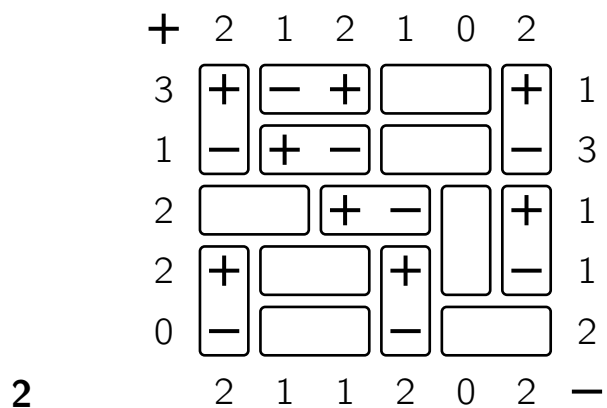
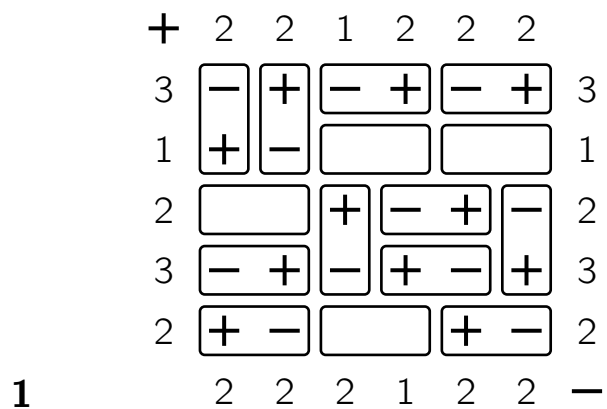

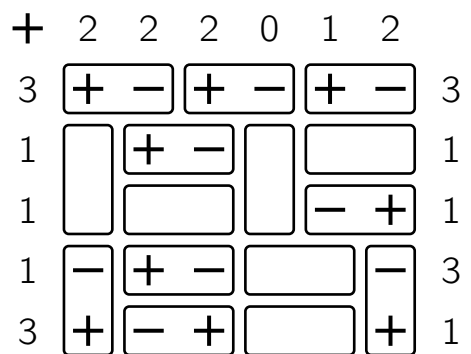

8

1 2 2 1 1 2 -

12

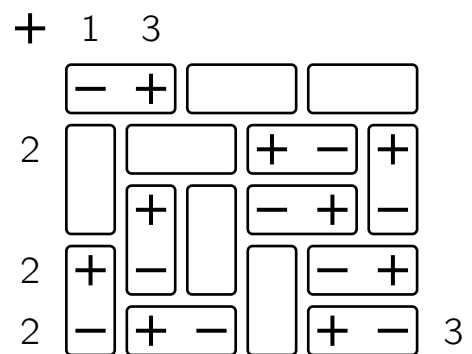

1 1 2 -

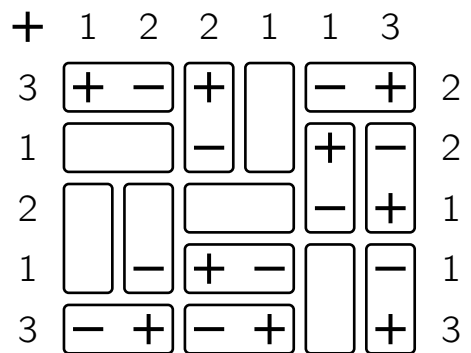

9

1 2 2 1 2 2 -

13

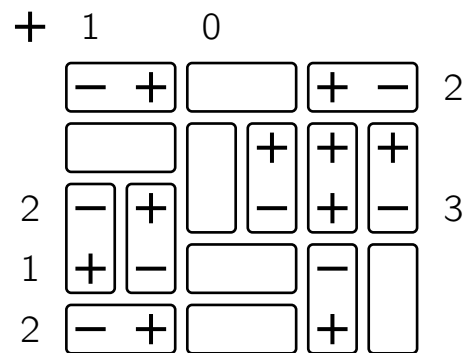

0 -

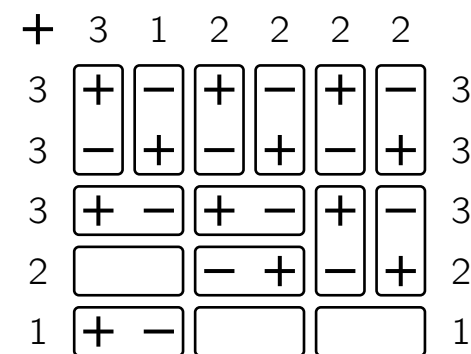

10

1 3 2 2 2 2 -

14

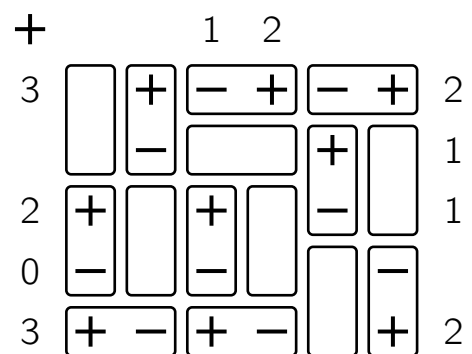

2 -

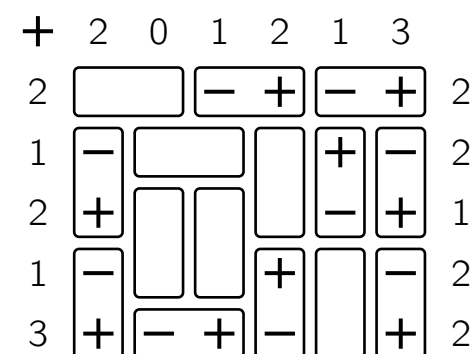

11

2 1 1 1 2 2 -

15

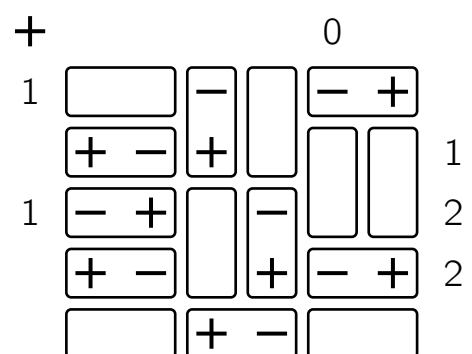

1 2 2 0 -

1

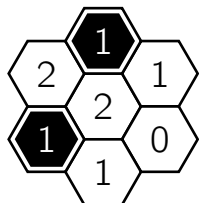

2

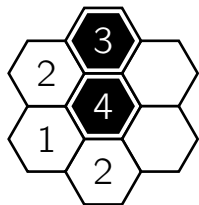

3

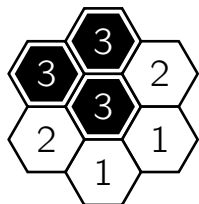

4

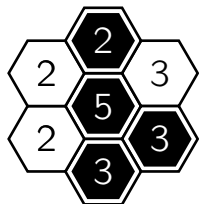

5

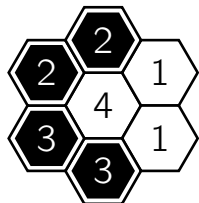

6

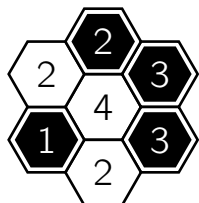

7

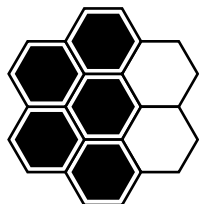

8

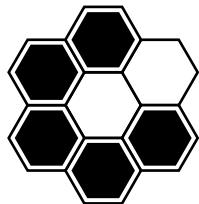

9

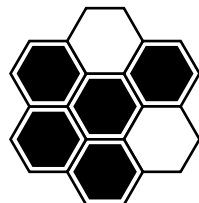

10

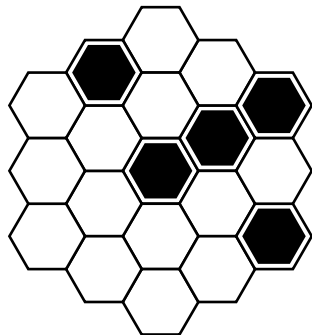

11

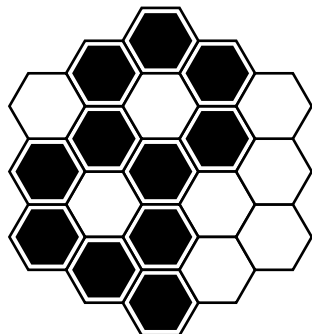

12

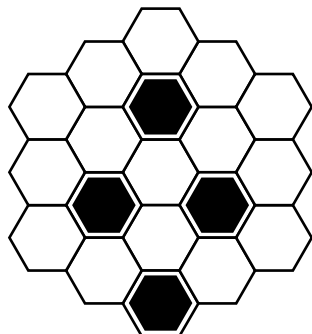

13

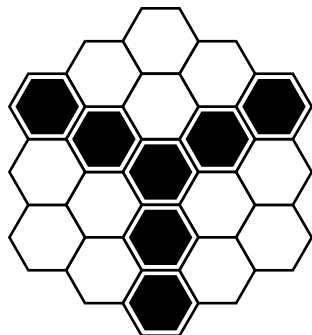

14

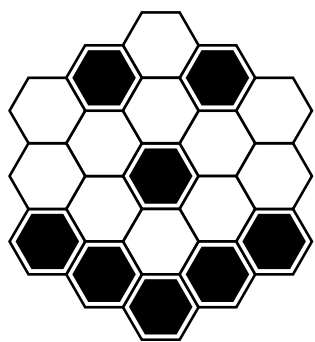

15

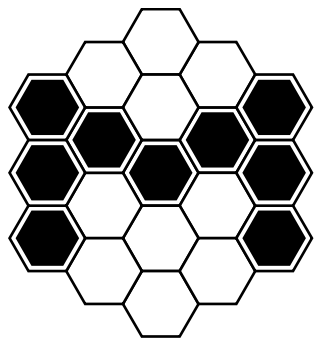

16

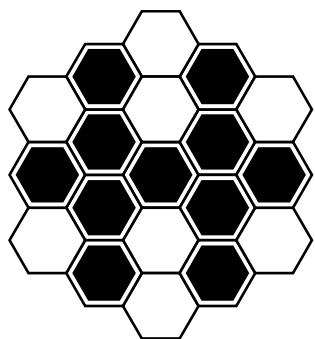

17

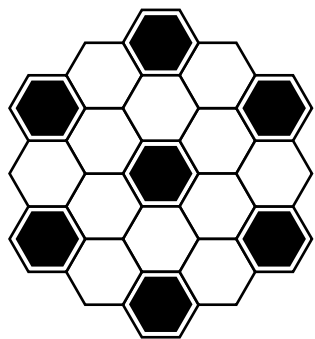

18

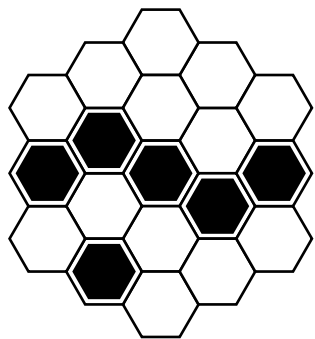

19

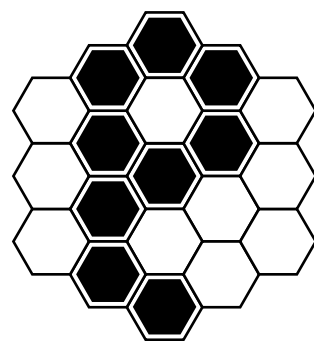

20

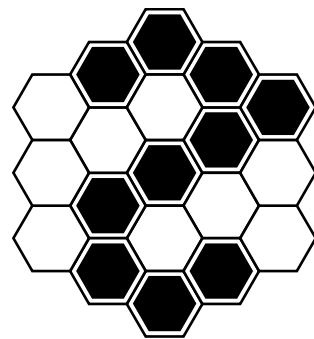

21

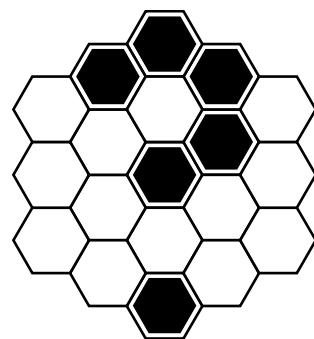

22

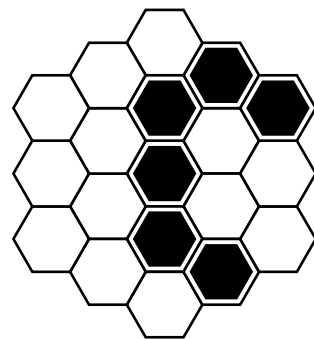

23

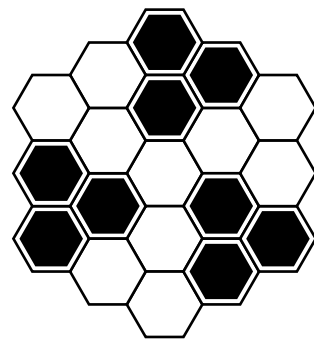

<b>1</b>	3 1 4	• 1 ◦ 1	<b>7</b>	2 5 6 4	• 2 ◦ 0
	2 2 4	• 0 ◦ 2		1 3 1 6	• 2 ◦ 0
	5 3 2	• 1 ◦ 0		3 5 1 2	• 2 ◦ 0
	<u>4 1 2</u>	• 3 ◦ 0		<u>1 6 2 4</u>	• 2 ◦ 0
	3 6 5	• 0 ◦ 1		1 5 1 4	• 4 ◦ 0
<b>2</b>	4 1 6	• 0 ◦ 2	<b>8</b>	6 1 5 6	• 0 ◦ 2
	5 1 3	• 0 ◦ 1		2 2 1 4	• 0 ◦ 2
	4 3 2	• 0 ◦ 1		4 5 4 3	• 0 ◦ 2
	<u>6 2 1</u>	• 3 ◦ 0		3 6 3 2	• 0 ◦ 2
	5 5 5 2	• 1 ◦ 2		<u>5 4 6 1</u>	• 0 ◦ 2
<b>3</b>	5 3 5 2	• 0 ◦ 3	<b>9</b>	<u>1 3 2 5</u>	• 4 ◦ 0
	6 4 5 2	• 1 ◦ 2		1 8 2 6	• 0 ◦ 1
	<u>6 5 2 5</u>	• 4 ◦ 0		2 4 8 3	• 0 ◦ 2
	1 3 6 4	• 2 ◦ 2		5 7 4 1	• 0 ◦ 2
<b>4</b>	3 1 4 3	• 0 ◦ 3	<b>10</b>	2 3 7 5	• 0 ◦ 2
	3 4 1 3	• 0 ◦ 3		3 6 5 7	• 0 ◦ 3
	<u>1 1 3 4</u>	• 0 ◦ 3		<u>6 5 3 4</u>	• 4 ◦ 0
	4 3 6 1	• 4 ◦ 0		2 1 3 8	• 0 ◦ 1
<b>5</b>	4 1 2 6	• 2 ◦ 0	<b>11</b>	6 5 1 4	• 0 ◦ 3
	3 4 6 5	• 2 ◦ 0		1 3 7 8	• 0 ◦ 2
	3 2 3 6	• 2 ◦ 0		5 8 4 6	• 0 ◦ 2
	5 1 6 4	• 2 ◦ 0		7 4 5 6	• 0 ◦ 3
	<u>3 1 6 6</u>	• 4 ◦ 0		<u>4 7 6 1</u>	• 4 ◦ 0
<b>6</b>	3 2 3 5	• 2 ◦ 0		4 1 6 1	• 0 ◦ 3
	1 1 6 3	• 2 ◦ 0		1 6 1 5	• 2 ◦ 1
	4 6 6 5	• 2 ◦ 0		<u>1 5 4 4</u>	• 3 ◦ 0
	<u>1 2 4 4</u>	• 2 ◦ 0		1 5 1 4	• 4 ◦ 0
	1 2 6 5	• 4 ◦ 0			



**12**

$$\begin{array}{rcccc} 2 & 3 & 5 & 5 & \bullet 0 \circ 3 \\ 3 & 5 & 2 & 5 & \bullet 2 \circ 1 \\ 2 & 4 & 5 & 1 & \bullet 0 \circ 3 \\ 1 & 5 & 2 & 5 & \bullet 2 \circ 1 \\ \hline 5 & 5 & 2 & 4 & \bullet 4 \circ 0 \end{array}$$

**13**

$$\begin{array}{rcccc} 2 & 5 & 2 & 4 & \bullet 1 \circ 2 \\ 4 & 2 & 3 & 5 & \bullet 0 \circ 4 \\ 4 & 6 & 3 & 2 & \bullet 1 \circ 2 \\ \hline 3 & 5 & 4 & 2 & \bullet 4 \circ 0 \end{array}$$

**14**

$$\begin{array}{rcccc} 3 & 2 & 5 & 1 & \bullet 1 \circ 2 \\ 2 & 6 & 5 & 2 & \bullet 1 \circ 2 \\ 2 & 5 & 3 & 1 & \bullet 3 \circ 1 \\ 1 & 1 & 2 & 2 & \bullet 1 \circ 2 \\ \hline 2 & 5 & 2 & 4 & \bullet 4 \circ 0 \end{array}$$

**15**

$$\begin{array}{rcccc} 6 & 3 & 2 & 2 & \bullet 1 \circ 2 \\ 5 & 1 & 3 & 2 & \bullet 1 \circ 2 \\ 5 & 2 & 2 & 2 & \bullet 2 \circ 1 \\ \hline 3 & 2 & 5 & 2 & \bullet 4 \circ 0 \end{array}$$

**16**

$$\begin{array}{rcccc} 3 & 1 & 3 & 5 & \bullet 1 \circ 2 \\ 6 & 3 & 3 & 1 & \bullet 0 \circ 3 \\ 6 & 2 & 5 & 3 & \bullet 2 \circ 1 \\ \hline 3 & 6 & 5 & 3 & \bullet 4 \circ 0 \end{array}$$

**17**

$$\begin{array}{rcccc} 6 & 4 & 5 & 2 & \bullet 1 \circ 3 \\ 1 & 6 & 2 & 4 & \bullet 0 \circ 3 \\ 4 & 3 & 6 & 5 & \bullet 2 \circ 1 \\ 1 & 2 & 4 & 5 & \bullet 1 \circ 2 \\ \hline 2 & 4 & 6 & 5 & \bullet 4 \circ 0 \end{array}$$

**18**

$$\begin{array}{rcccc} 1 & 2 & 3 & \bullet 1 \circ 0 \\ 1 & 4 & 7 & \bullet 0 \circ 1 \\ 4 & 5 & 6 & \bullet 1 \circ 0 \\ 2 & 5 & 8 & \bullet 0 \circ 1 \\ 7 & 8 & 9 & \bullet 1 \circ 0 \\ 3 & 6 & 9 & \bullet 1 \circ 0 \\ \hline 4 & 2 & 9 & \bullet 3 \circ 0 \end{array}$$

**19**

$$\begin{array}{rcccc} 6 & 2 & 3 & 4 & \bullet 1 \circ 0 \\ 7 & 1 & 2 & 6 & \bullet 1 \circ 0 \\ 3 & 7 & 6 & 8 & \bullet 1 \circ 1 \\ 5 & 6 & 1 & 2 & \bullet 1 \circ 1 \\ \hline 5 & 1 & 3 & 8 & \bullet 4 \circ 0 \end{array}$$

**20**

$$\begin{array}{rcccc} 5 & 5 & 5 & 5 & \bullet 1 \circ 0 \\ 6 & 5 & 2 & 1 & \bullet 2 \circ 1 \\ 1 & 2 & 3 & 4 & \bullet 1 \circ 1 \\ 3 & 4 & 6 & 2 & \bullet 0 \circ 1 \\ \hline 5 & 2 & 2 & 1 & \bullet 4 \circ 0 \end{array}$$

1

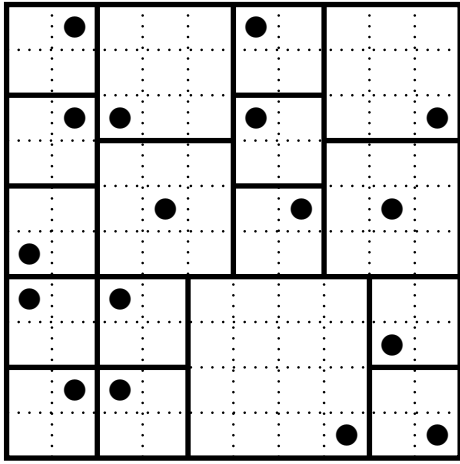

4

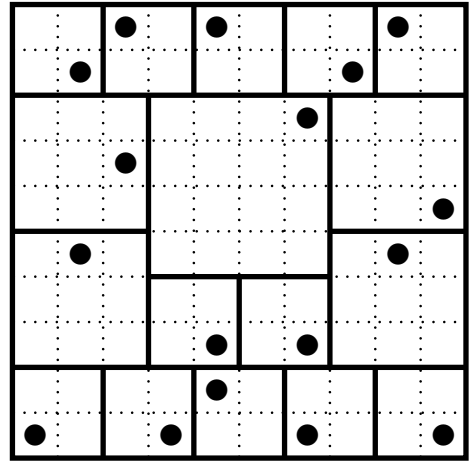

2

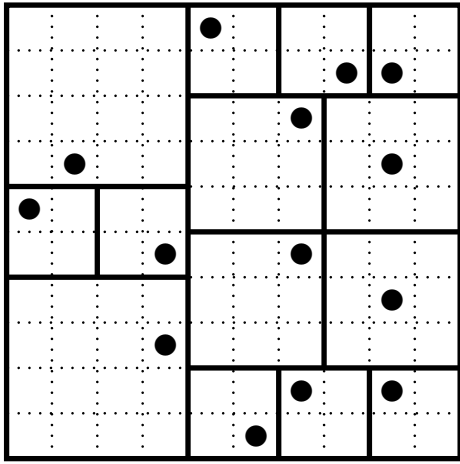

5

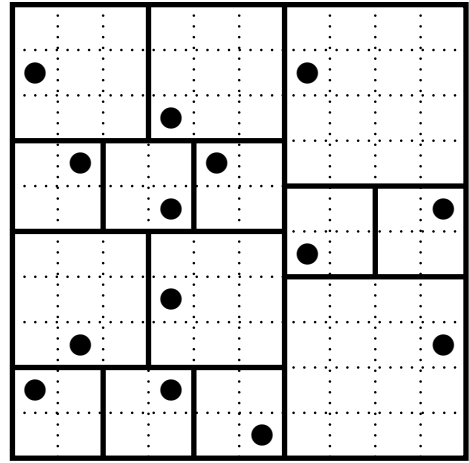

3

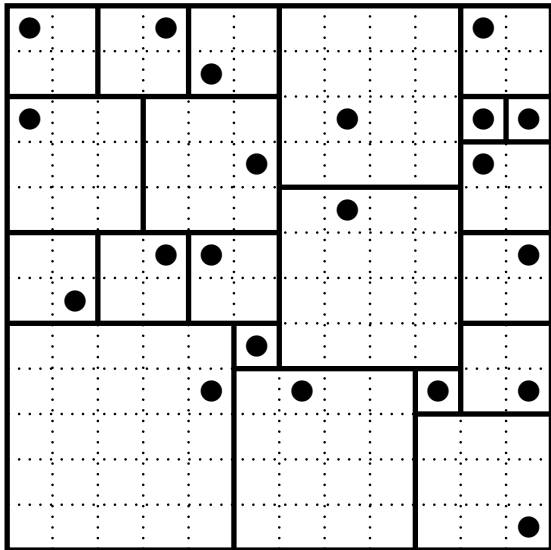

6

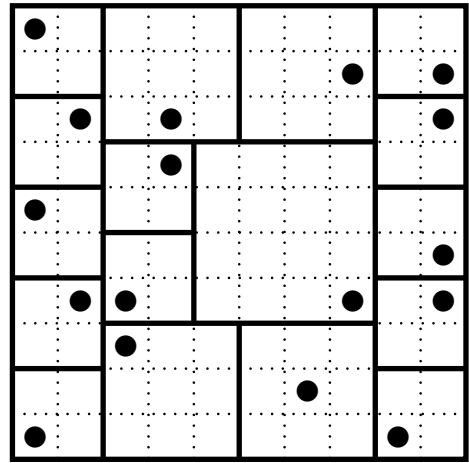

7

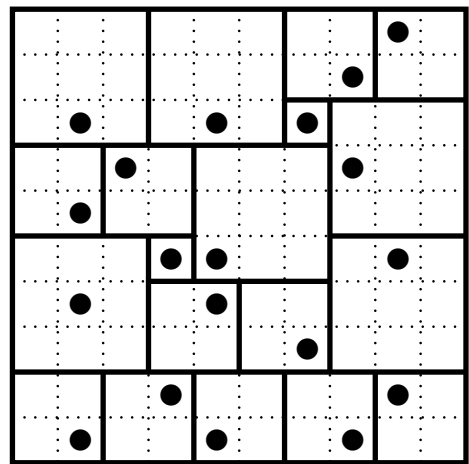

8

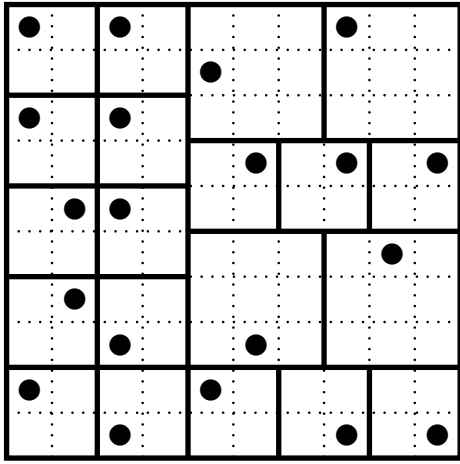

9

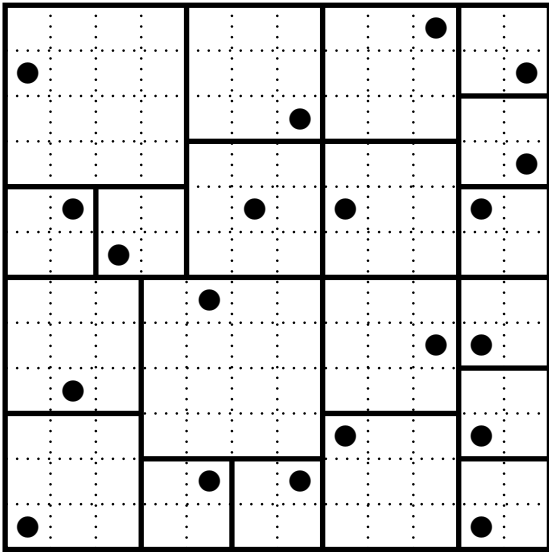

10

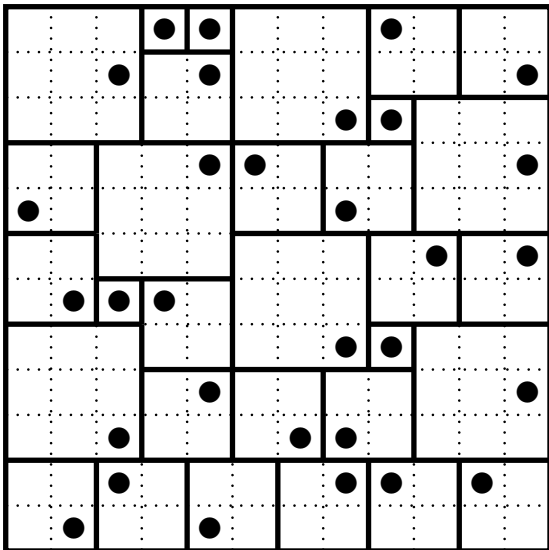

11

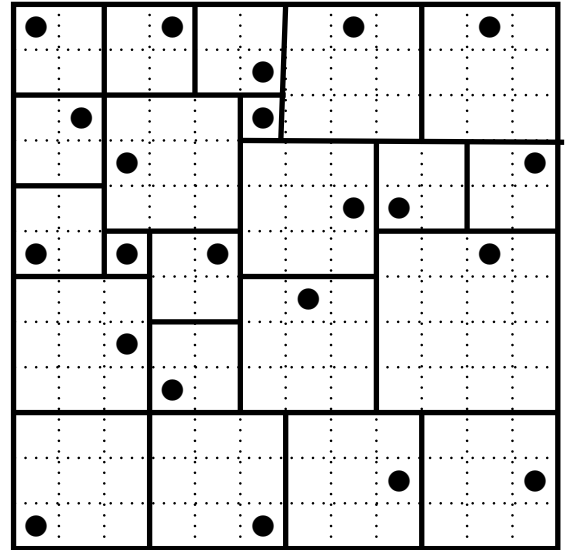

12

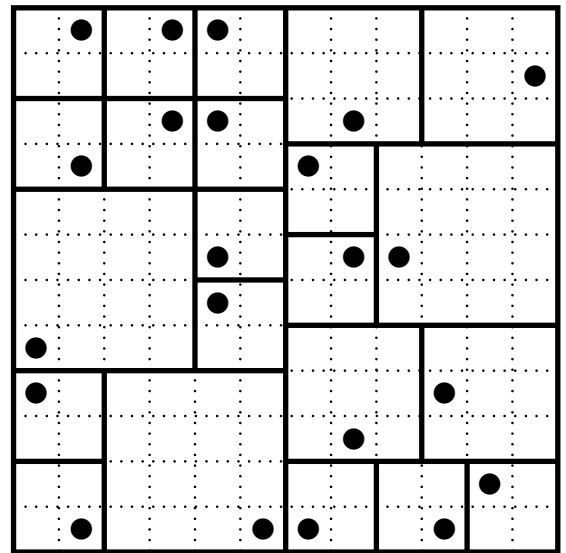

13

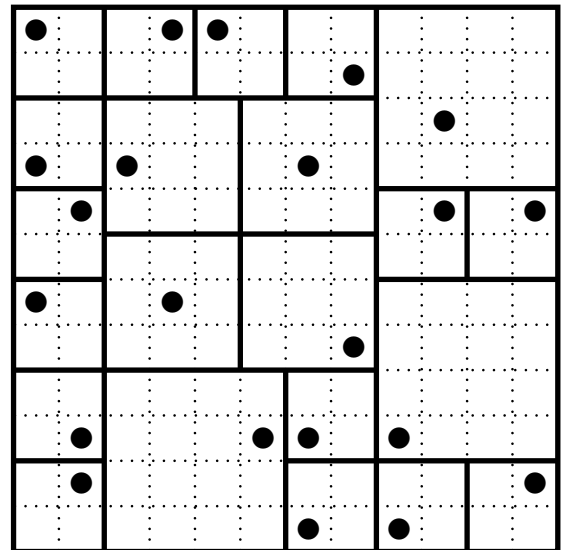

1

☀		●	0	
		1	●	☀
2	☀	2	2	●
●		☀		
0	●	2	☀	

6

●	☀		1	2
		●		☀
☀		2	●	
	●	☀		2
		2	☀	●

2

☀		2	●	
	●	2	☀	
2	☀			●
●	2	☀		
0		●	2	☀

7

●		☀	2	1
			☀	●
	1	●	2	☀
	☀		●	
☀	●	0		1

3

☀		●		
2	☀	2	●	1
●		2	2	☀
1			☀	●
0	●	☀	2	

8

	●	☀	2	
2		2	☀	●
☀	2	●	1	
●				☀
1	☀		●	1

4

☀		2		●
●		☀		
	☀	●		
		0	●	☀
0	●		☀	

9

0	●			☀
	☀	●	0	
●		☀	1	
☀		2	●	
			☀	●

5

☀		●		
●	☀	2	2	
1		2	☀	●
0	●	☀		2
		1	●	☀

10

1	☀	2	●	
●		☀		
		●		☀
☀	●	0		
2	1		☀	●

11

		☀	●	
●	☀	2	2	2
☀	2	●		1
	●		1	☀
			☀	●

12

		☀	●	
●	☀	2	2	2
☀	2	●		1
	●		1	☀
			☀	●

13

☀		2	●	0	
●		☀			
0		●			☀
	☀	1	2	●	
		1	☀	2	●
0	●	1		☀	

14

●	☀				
☀	●		0	0	
		0	●		☀
		●	☀		
		☀		●	
2		2	2	☀	●

15

●	1		☀	2	
	●	☀	2		
2	☀	●			0
2	2	1	2	☀	●
☀			2	●	
			●		☀

16

●			☀	1	2
2		☀	●		
2	☀	2	1	●	
	●				☀
☀					●
	0	●		☀	

17

1		☀		●	1
	●	2			☀
●	☀			2	2
☀	2			2	●
			●	☀	1
1		●	☀	2	1

18

2		☀		●	1
1	1	●			☀
2	☀	1	●	1	1
☀			2		●
	●		☀		
●	1		2	☀	1

19

2		☀	1		●
	1	1	●		☀
2	☀	●		0	
☀			2	●	
●			☀	2	
0	●			☀	

20

	●		☀	2	
●	2			☀	2
	☀	2	2	●	1
		☀	●		
		●	1		☀
☀	2	1			●





1

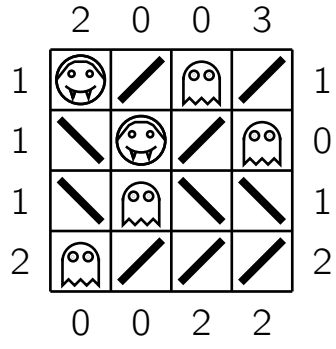

2

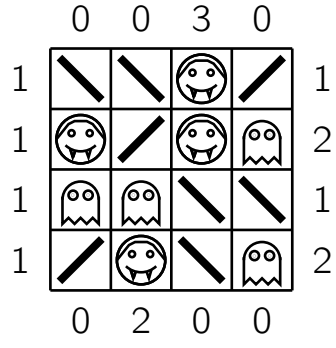

3

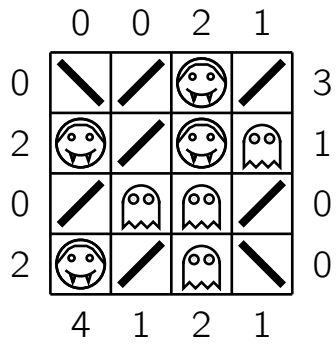

4

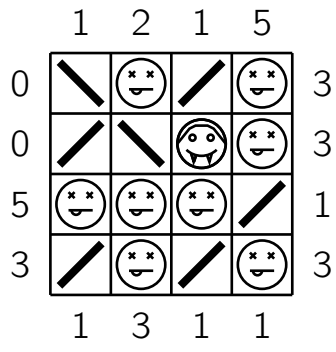

5

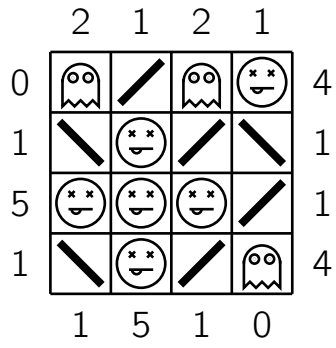

6

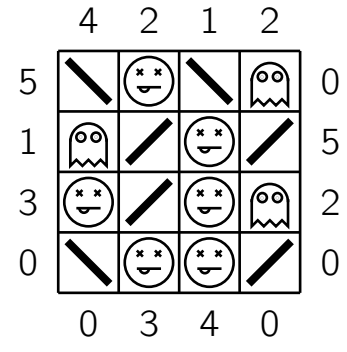

7

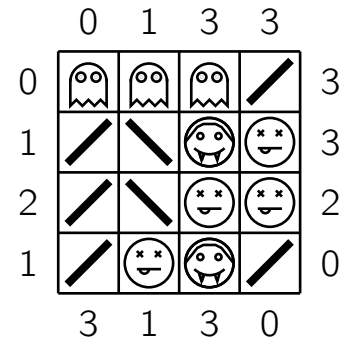

8

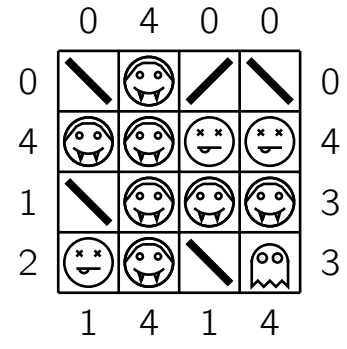

9

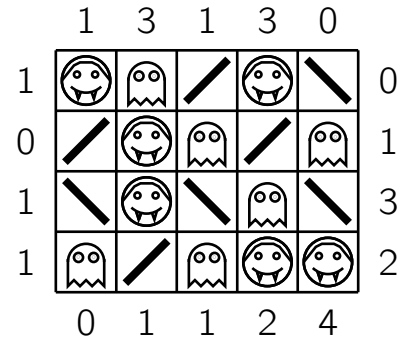

10

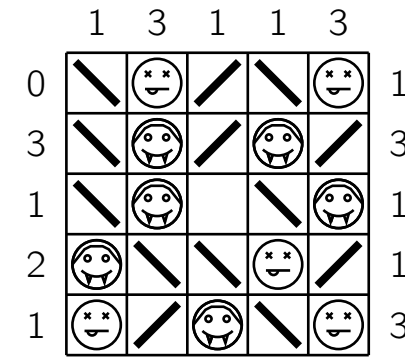



11

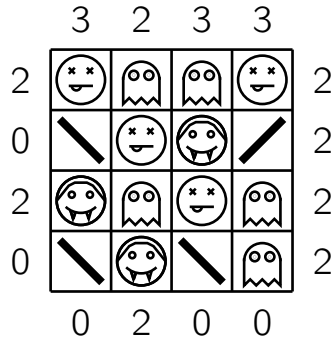

12

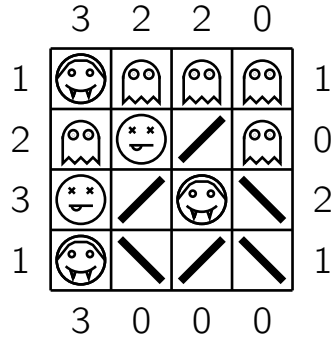

13

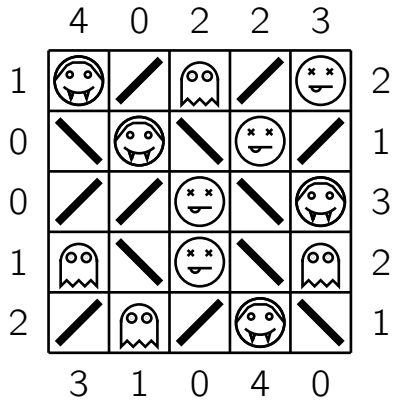

14

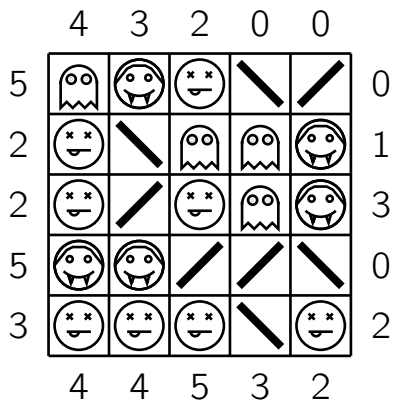

15

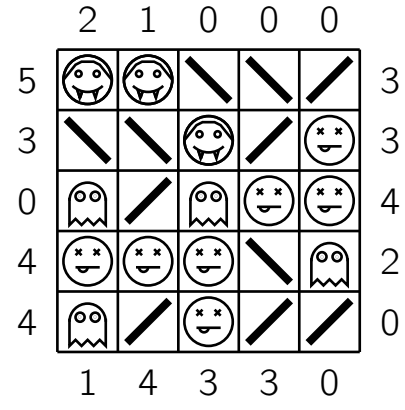

16

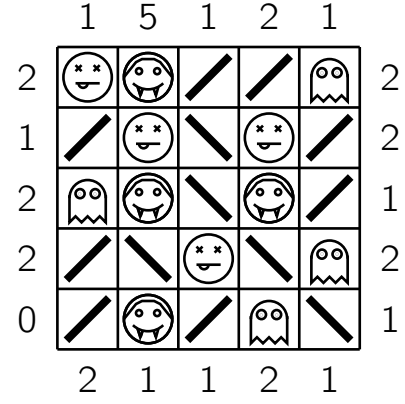

17

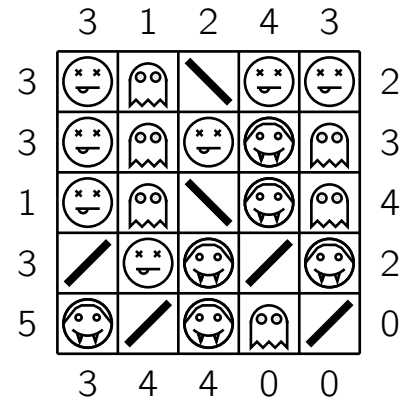

18

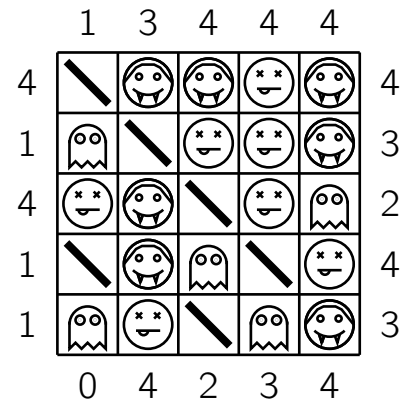

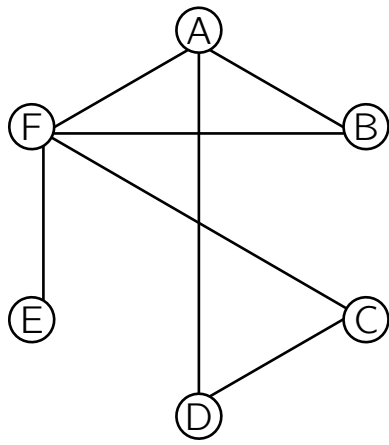

19

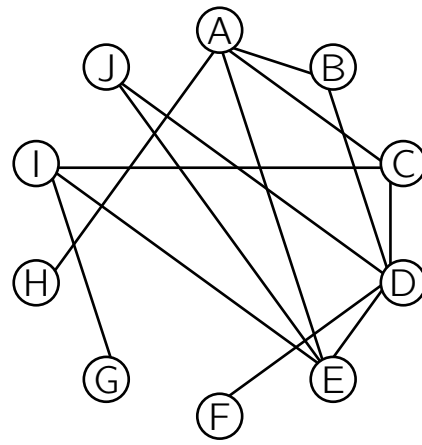

21

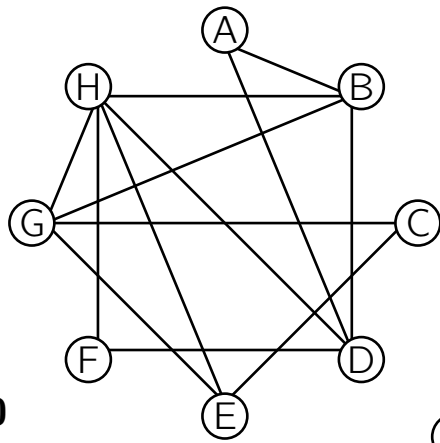
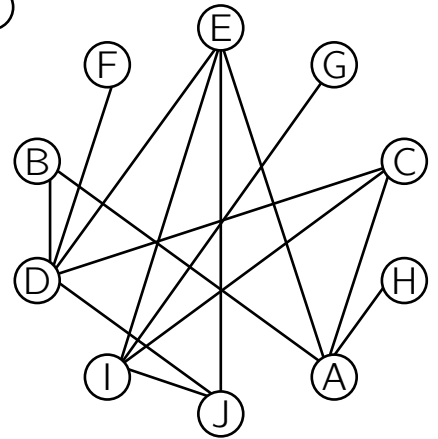
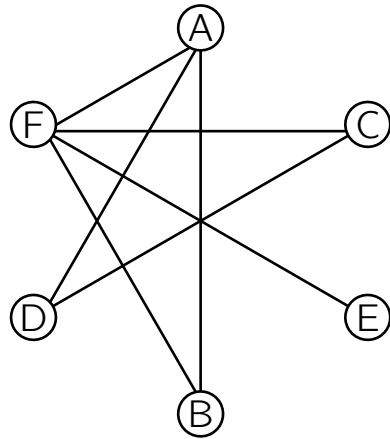

20

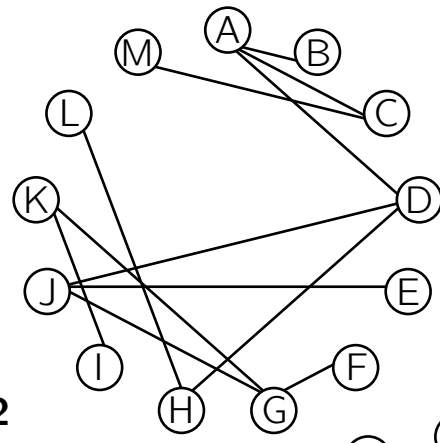

22

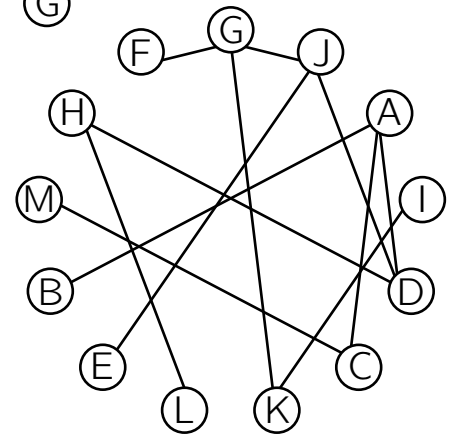
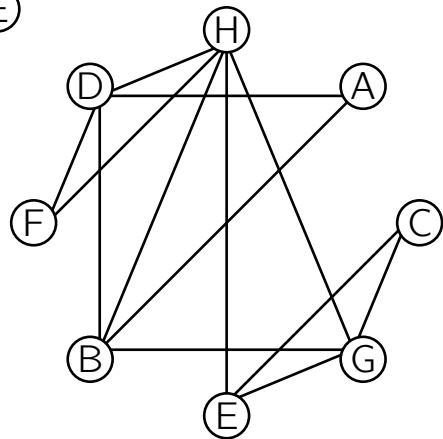

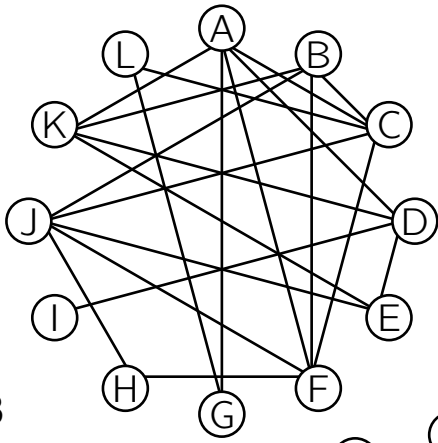

23

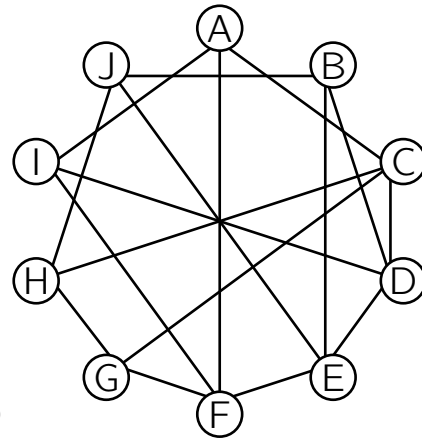

25

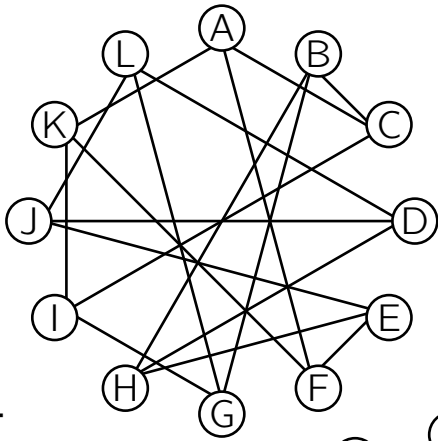
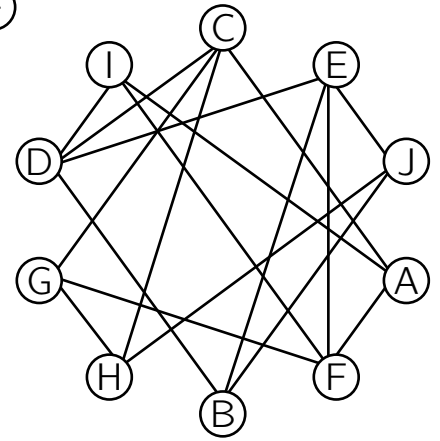
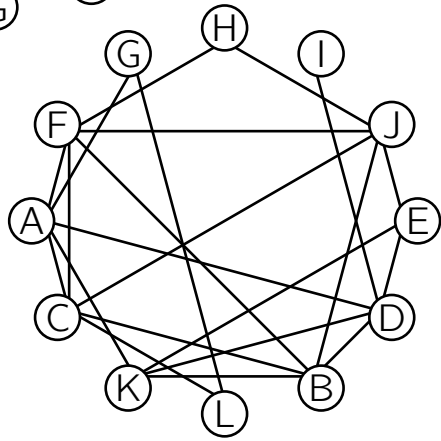

24

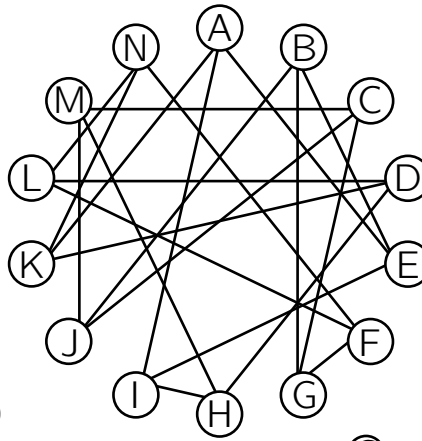

26

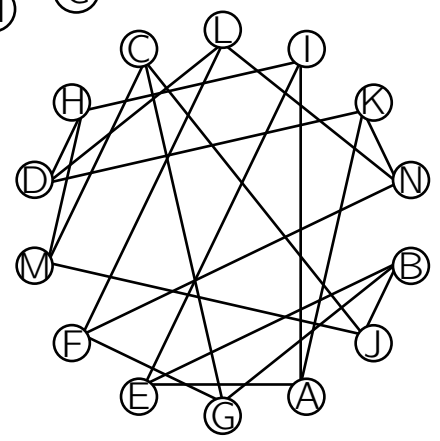
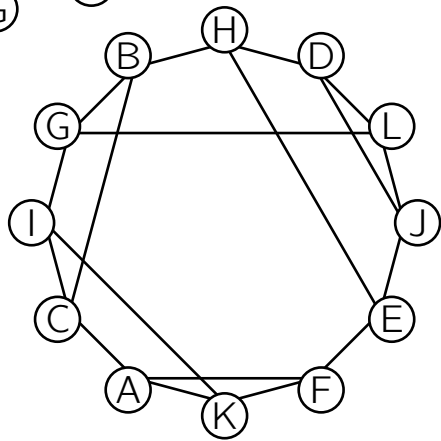

1

6	1	2	3	2	1
5	4	6	5	4	3
2	3	1	2	1	2
1	5	4	3	4	3
3	6	2	1	6	2
2	1	3	4	4	1

2

6	5	4	6	5	4
4	2	3	1	2	3
3	1	6	5	4	1
2	5	2	1	3	2
1	4	3	5	6	1
3	2	1	4	3	2

3

3	2	1	5	1	2
4	5	3	4	6	3
1	6	2	1	5	4
2	5	4	3	2	1
3	1	2	6	5	4
5	4	3	1	2	3

4

1	6	7	6	1	2
2	5	1	5	4	3
3	4	2	7	6	5
2	1	3	4	3	4
3	4	5	1	2	7
1	2	3	4	5	6

5

1	6	1	6	2	1
2	5	2	5	3	4
1	4	1	4	1	5
2	3	2	3	2	6
1	4	5	6	4	3
2	3	1	2	1	2

6

3	2	1	2	1	2	1	3
4	6	5	3	4	3	5	2
5	1	4	1	5	1	4	1
6	2	3	2	3	2	3	2
1	4	1	5	4	6	5	1
2	3	2	3	1	2	4	3
1	4	5	4	5	6	1	2
2	3	1	2	3	4	5	6

7

2	3	1	2	3	1	2	3
1	4	5	4	5	4	5	4
2	3	2	3	2	3	2	3
1	5	1	5	1	5	1	5
3	4	3	4	3	4	3	4
2	1	2	1	2	1	2	1
4	3	4	3	4	3	4	3
1	2	1	2	1	2	1	2

8

2	3	4	5	4	5	3	2
1	5	2	1	3	2	4	1
2	4	3	5	4	1	3	2
1	5	2	1	3	2	4	1
3	4	3	5	4	1	3	2
2	1	2	1	3	2	4	1
5	4	3	5	4	1	3	2
1	2	1	2	3	5	4	1

9

1	5	4	3	2	1	6	1
2	6	2	1	4	3	5	2
3	4	3	6	5	2	4	1
6	5	1	2	3	1	3	2
4	2	3	5	4	5	4	1
3	1	4	6	3	2	3	2
2	6	5	1	4	1	4	1
1	4	3	2	5	6	3	2

10

1	2	1	2	1	2	1	2
4	3	4	3	4	3	4	3
5	1	5	1	5	1	5	1
4	2	3	2	3	2	3	2
3	5	4	5	4	5	4	1
2	1	2	1	2	1	3	2
4	5	3	4	3	5	4	1
3	2	1	5	2	1	3	2

14

3	1	2	3	2	1	3	2
2	4	5	4	5	6	4	1
1	3	6	3	2	1	3	2
6	2	5	4	6	5	4	1
5	1	6	3	2	1	3	2
4	3	5	4	6	5	4	1
1	2	1	2	1	2	3	2
6	5	4	3	6	5	4	1

11

3	2	7	6	5	8	7	6	5	2
4	1	4	3	4	3	2	1	4	1
5	6	7	2	7	9	8	7	3	2
2	1	8	1	6	5	1	6	5	1
3	7	9	2	3	4	2	3	4	9
1	6	5	1	9	8	5	6	7	8
2	3	4	3	4	7	4	3	2	1
6	5	1	2	5	6	2	1	5	4
7	4	3	8	9	4	3	7	6	3
8	1	2	7	6	5	1	2	1	2

12

3	4	7	8	5	4	1	8
2	5	6	2	1	3	2	7
1	8	1	3	8	4	5	6
6	7	2	6	7	3	2	1
5	4	3	5	2	1	6	5
3	2	1	4	3	8	7	4
1	4	5	6	7	1	2	3
2	3	1	2	3	4	5	6

13

3	2	1	2	1	3	2	5
5	4	5	4	5	4	1	4
2	3	2	3	2	3	2	3
1	5	1	5	1	4	1	5
3	4	3	4	3	5	3	4
2	1	2	1	2	1	2	1
3	4	3	4	3	4	3	4
2	1	2	1	2	1	2	1

1

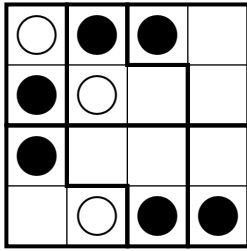

2

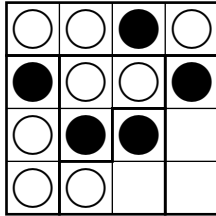

3

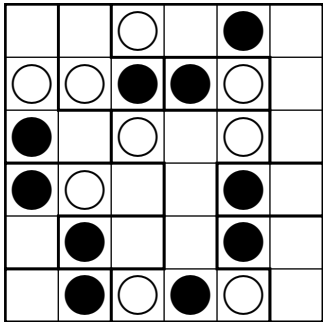

4

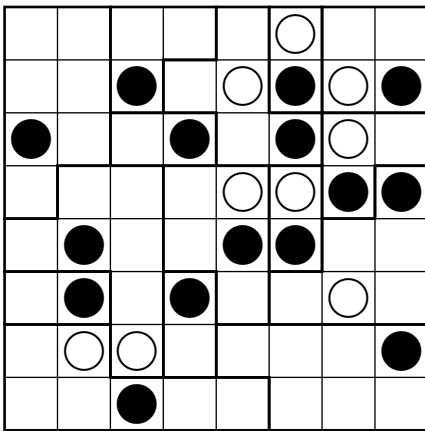

5

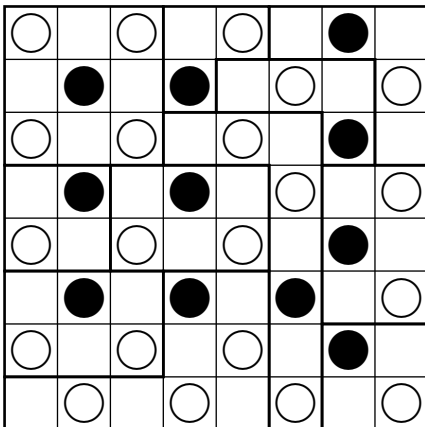

6

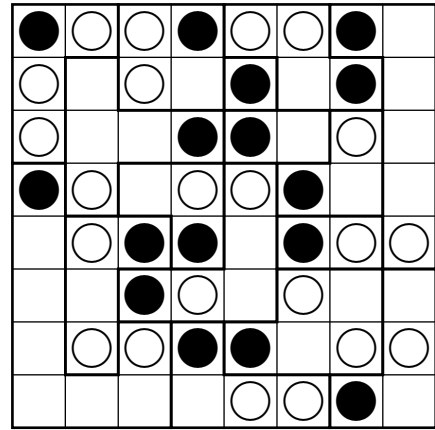

7

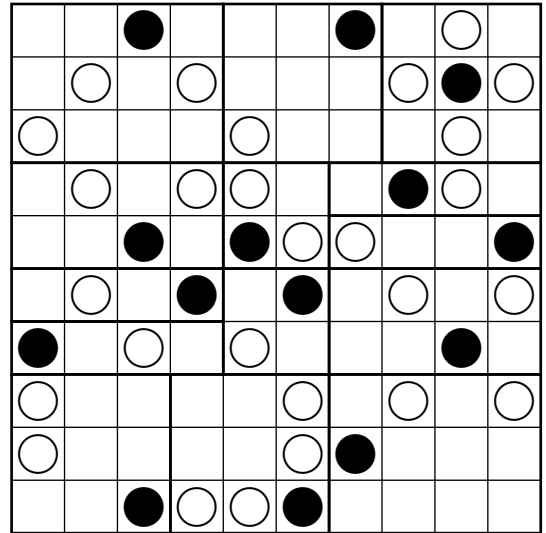

8

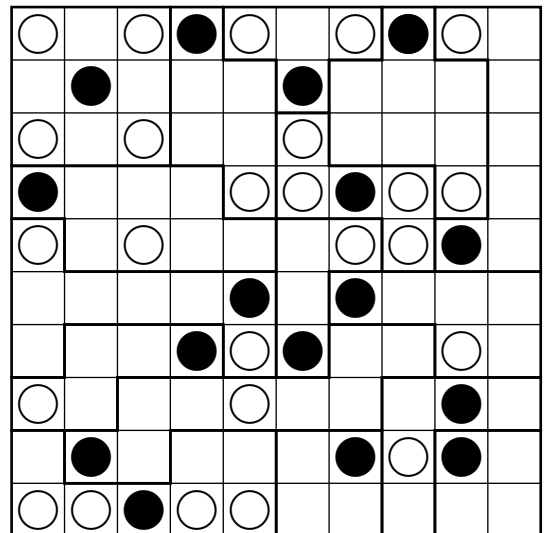

9

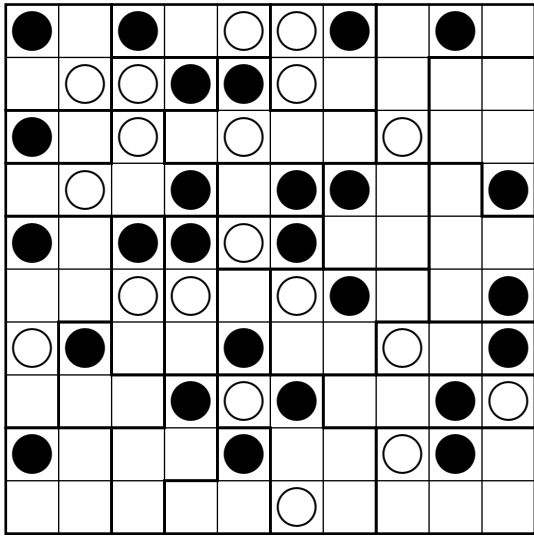

10

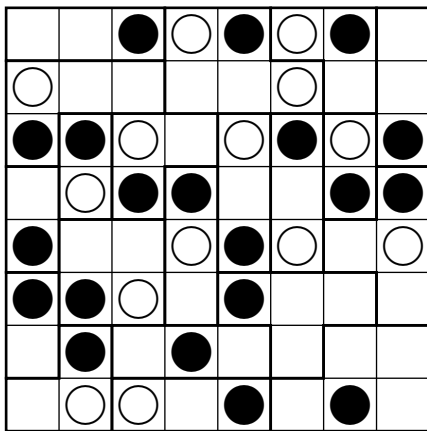

11

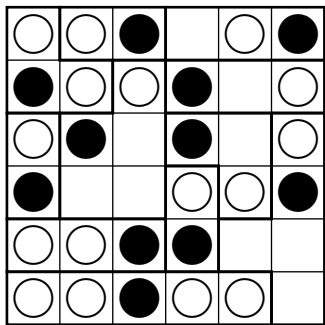

12

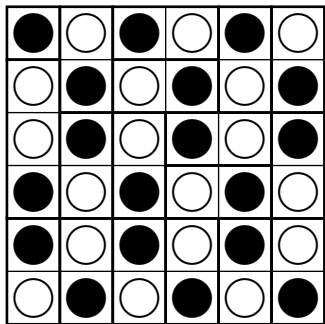

13

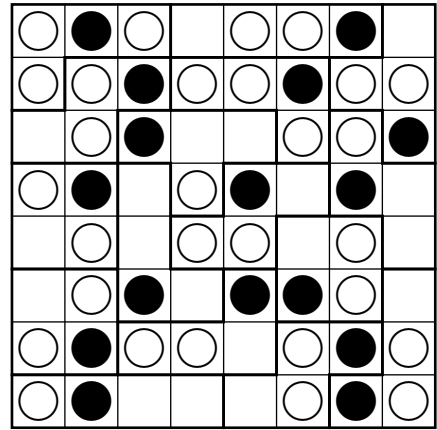

14

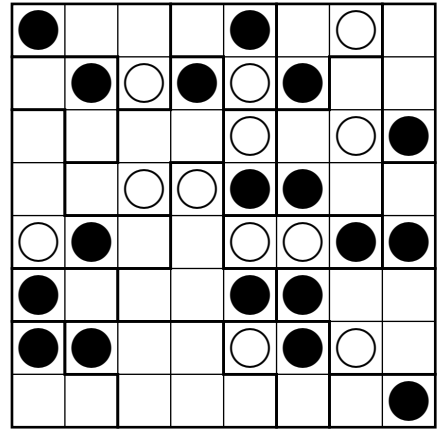

1

	16	7	18	5
18	■	5	6	7
8	5	2	■	1
10	4	■	5	1
14	7	■	7	■

6

	10	25	10	19
17	1	7	9	■
18	■	9	■	9
4	■	■	1	3
25	9	9	■	7

2

	17	13	19	16
15	7	■	■	8
24	7	8	9	■
12	3	■	1	8
14	■	5	9	■

7

	15	16	16	18
16	8	2	■	6
13	4	6	■	3
25	■	8	8	9
11	3	■	8	■

3

	27	17	17	12
19	■	9	6	4
14	9	■	3	2
16	8	■	8	■
19	5	8	■	6

8

	16	11	13	9
10	4	■	■	6
18	■	7	8	3
6	5	■	1	■
15	7	4	4	■

4

	8	22	14	13
10	2	7	■	1
19	■	8	6	5
17	■	7	3	7
11	6	■	5	■

9

	10	9	10	17	13
7	■	■	2	■	5
14	■	■	8	6	■
22	6	2	■	9	5
11	■	7	■	1	3
5	4	■	■	1	■

5

	11	15	15	12
14	■	4	3	7
13	4	3	6	■
13	7	■	6	■
13	■	8	■	8

10

	11	13	19	11	9
9	3	6	■	■	■
21	6	7	3	5	■
5	2	■	■	3	■
15	■	■	9	■	6
13	■	■	7	3	3



11

17 22 13 27 13

32	7	8		9	8
19	8	5	2	4	
21	2	9		9	1
4			1		3
16			8	7	1

16

16 12 20 24 13

20	7	5	8		
7		2	5		
15		1		7	7
19	4	4	2	9	
14	5		5	8	6

12

19 6 23 16 15

8			6		2
12			3		9
19	8			7	4
20	2	3	6	9	
20	9	3	8		

17

9 18 17 14 21

16		9	7		
12	5				7
16			7	6	3
23		9		8	6
12	4		3		5

13

4 11 10 19 14

10	2	4	1	3	
2			1	1	
13	1	2	2		8
13	1			6	6
20		5	6	9	

18

17 20 27 18 23

10	8				2
31		8	7	9	7
22	6	1	7		8
24	3	7	8		6
18		4	5	9	

14

19 12 9 15 20

24	9		4	6	5
15	9				6
9	1		5		3
18		5		7	6
9		7		2	

19

9 17 22 28 12

18	6	4	4		4
18		5		9	4
18			9	6	3
15			9	6	
19	3	8		7	1

15

16 10 10 12 29

21	5	8			8
7	5		2		
17	5	1		3	8
17	1		8	2	6
15		1		7	7

20

19 13 5 18 16

13		4		9	
13	6			5	2
14	5		2		7
13		9		4	
18	8		3		7

1

3	4	2	3	1	2	4	1
4	3	1	2	4	3	1	2
1	4	2	1	3	4	2	3
2	1	3	4	2	1	3	4
3	2	4	1	3	2	4	1
2	1	3	4	2	1	3	4
4	3	1	2	4	3	1	2
1	2	4	3	1	4	2	3

2

3	1	4	2	4	3	1	2
4	3	2	4	3	1	2	1
2	4	1	2	4	3	1	3
1	2	3	1	3	4	2	4
3	1	4	3	1	2	4	2
4	3	2	1	2	4	3	1
2	4	1	3	1	2	4	3
1	2	3	4	2	1	3	4

3

1	3	2	1	3	2	1	3	2
2	1	3	2	1	3	2	1	3
3	2	1	3	2	1	3	2	1
1	3	2	1	3	2	1	3	2
2	1	3	2	1	3	2	1	3
3	2	1	3	2	1	3	2	1
1	3	2	1	3	2	1	3	2
2	1	3	2	1	3	2	1	3
3	2	1	3	2	1	3	2	1

4

1	2	3	1	2	3	2	1	3
2	3	1	2	3	2	1	3	1
3	2	3	1	2	1	3	1	2
1	3	2	3	1	2	1	2	3
2	1	3	1	2	3	2	3	1
1	2	1	2	3	1	3	2	3
3	1	2	3	1	3	2	1	2
2	3	1	2	3	1	3	2	1
3	1	2	3	1	2	1	3	2

5

3	2	1	2	3	1	3	2	1
1	3	2	3	1	2	1	3	2
2	1	3	1	2	3	2	1	3
3	2	1	3	1	2	3	2	1
2	1	3	2	3	1	2	1	3
1	3	2	1	2	3	1	3	2
3	2	1	3	1	2	3	2	1
2	1	3	2	3	1	2	1	3
1	3	2	1	2	3	1	3	2

6

1	2	3	2	3	1	2	3	1
2	3	1	3	1	2	3	1	2
1	2	3	1	2	3	1	2	3
3	1	2	3	1	2	3	1	2
2	3	1	2	3	1	2	3	1
1	2	3	1	2	3	1	2	3
3	1	2	3	1	2	3	1	2
2	3	1	2	3	1	2	3	1
3	1	2	1	2	3	1	2	3

7

3	1	4	2	4	3	1	2
4	3	2	4	3	1	2	1
2	4	1	2	4	3	1	3
1	2	3	1	3	4	2	4
3	1	4	3	1	2	4	2
4	3	2	1	2	4	3	1
2	4	1	3	1	2	4	3
1	2	3	4	2	1	3	4

10

1	3	2	4	1	4	2	3
3	4	3	1	2	1	4	2
2	3	4	2	1	3	1	4
4	1	2	4	3	2	3	1
1	2	1	3	4	3	4	2
2	4	3	1	2	4	3	1
4	1	4	3	3	1	2	3
3	2	1	3	4	2	1	4

8

1	4	3	2	4	2	1	3
3	1	2	4	1	3	4	2
4	3	4	1	2	1	2	3
3	2	1	4	3	4	1	2
2	3	2	1	4	3	4	1
1	2	4	3	1	2	3	4
4	1	3	2	3	4	2	1
2	4	1	3	2	1	3	4

11

2	1	3	4	1	4	3	2
4	3	1	3	2	1	2	4
1	4	2	1	3	2	4	3
3	2	4	2	1	4	3	1
4	1	2	3	4	3	1	2
1	2	3	4	2	1	4	3
3	4	1	2	3	2	1	4
2	3	4	1	4	3	2	1

9

2	3	1	3	2	3	1	2	1
1	2	3	2	1	2	3	1	3
3	1	2	1	3	1	2	3	2
1	2	1	3	2	3	1	2	3
2	1	3	2	3	1	2	3	1
3	2	1	3	1	2	3	1	2
1	3	2	1	2	3	1	2	3
3	1	3	2	1	2	3	1	2
2	3	2	1	3	1	2	3	1

12

3	1	2	3	1	2	3	1	2
2	3	1	2	3	1	2	3	1
3	1	2	3	1	2	1	2	3
1	2	3	1	2	3	2	3	1
2	3	1	2	1	2	3	1	3
1	2	3	1	3	1	2	3	2
3	1	2	3	2	3	1	2	1
2	3	1	2	3	1	3	1	2
1	2	3	1	2	3	1	2	3

1

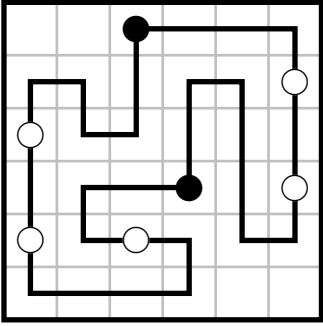

2

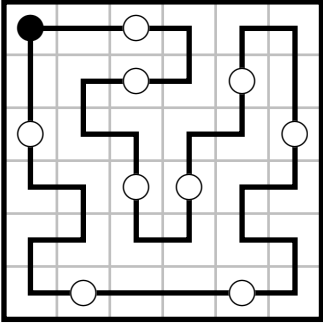

3

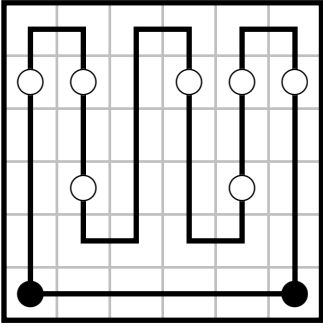

4

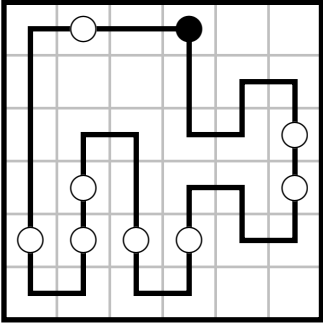

5

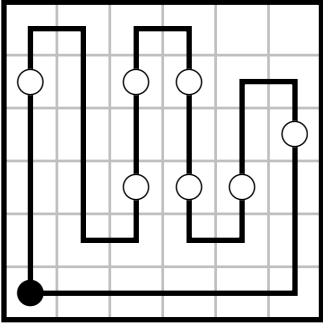

6

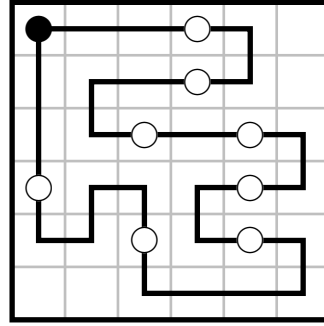

7

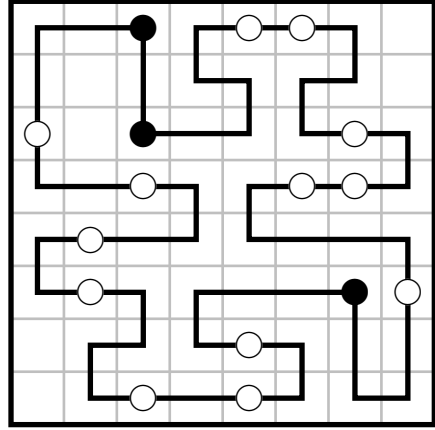

8

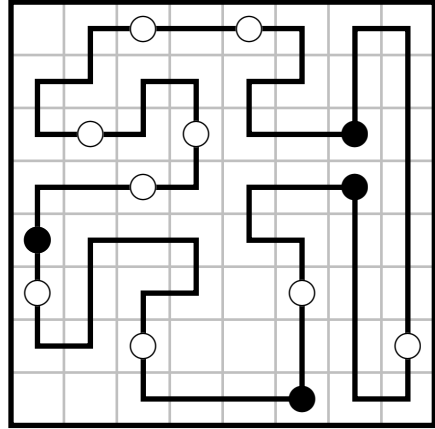

9

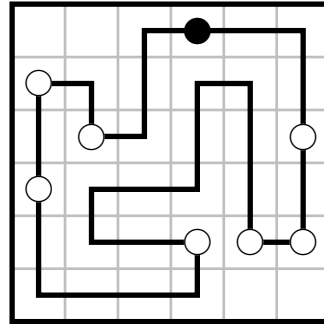

10

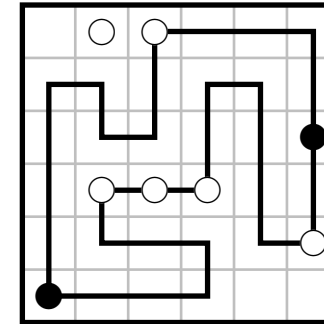

11

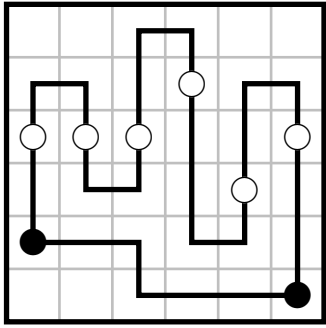

12

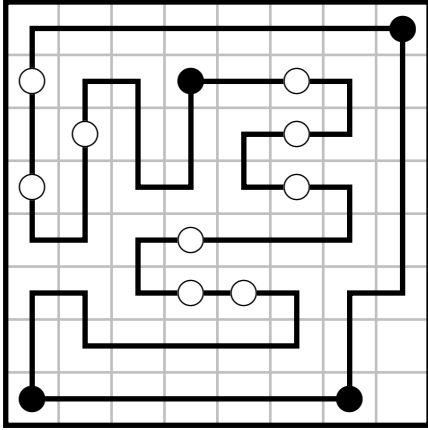

13

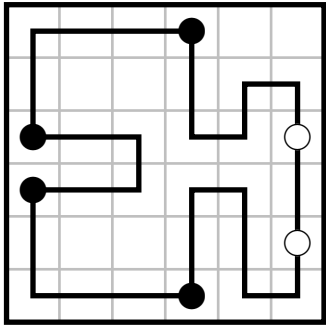

14

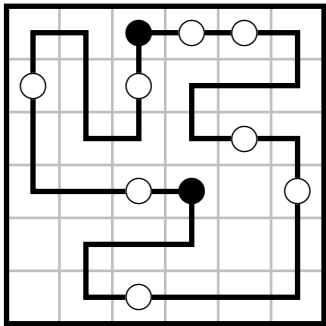

15

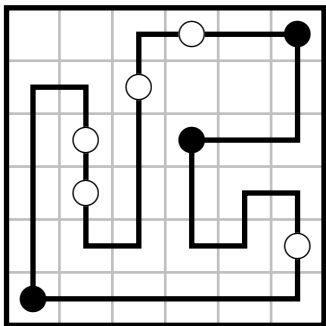

16

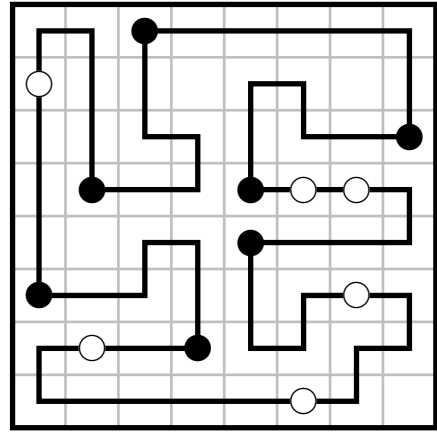

1

		3				
					1	
			1			
						1
	0					
			2			

5

				0		
						3
1						
				1		
		4				
						2

2

			2			
	0			1		
	1					
					1	

6

						0
				1		
						3
			2			
	3					2

3

				1		
	1					
						1
				2		
	1					
					3	

7

	1					
				3		
1				3		
						0
	2					

4

	4					
						2
	1					
						1
		0		1		

8

				2		
			1			
2						
				1		
	2					0

9

			3			1
	▲		▲		2	
						▲
	▲		3	3		
						1
	▲			▲		
		4				1
	▲			▲		
	7		▲	▲		▲

12

▲		▲		▲	4	3	
	▲		2				▲
					1		
	1						
			4				▲
▲		▲				2	
				▲			▲
	2				▲		
				▲			
							4

10

	▲		▲		2		2
			▲		▲		
	1						1
		4		▲			
▲							2
		▲		▲	2		
	3		▲	4			▲

13

	3	5		▲		▲	▲
▲							
			▲	3			▲
3							
			▲	2			3
▲							
			2		▲		▲
▲	1						

11

						▲	
3		1					▲
		▲		▲	5		
▲							
		▲		▲			3
3					▲		
		1					▲
	1			▲	1		
							1
▲						▲	

14

							2
▲		▲		▲	4		
							2
					▲		
4		▲				1	
					▲		
▲		4					▲
					2		
▲		4					▲
						▲	

1

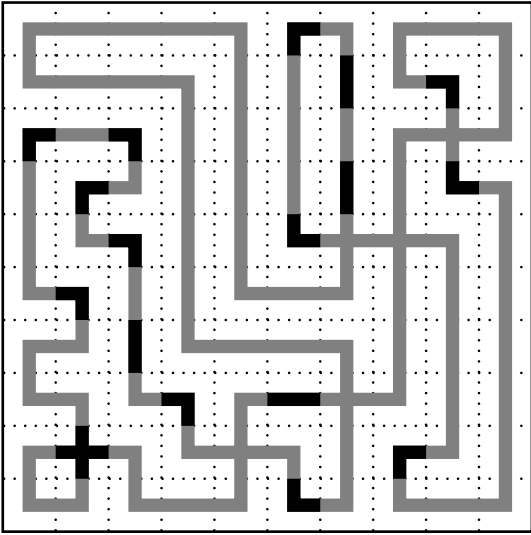

4

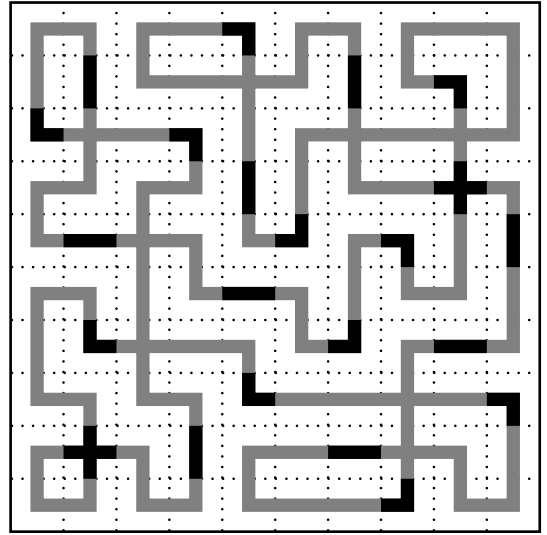

2

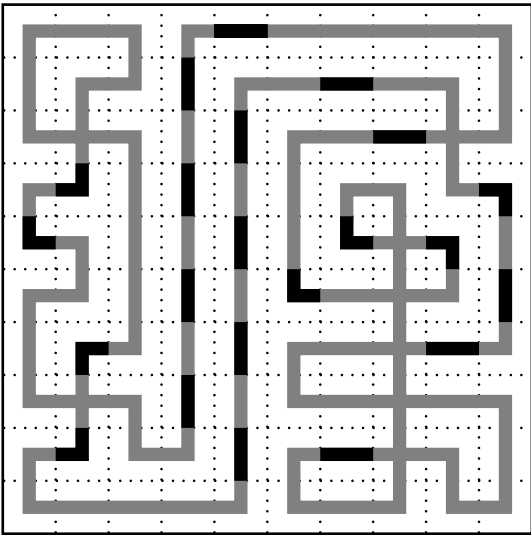

5

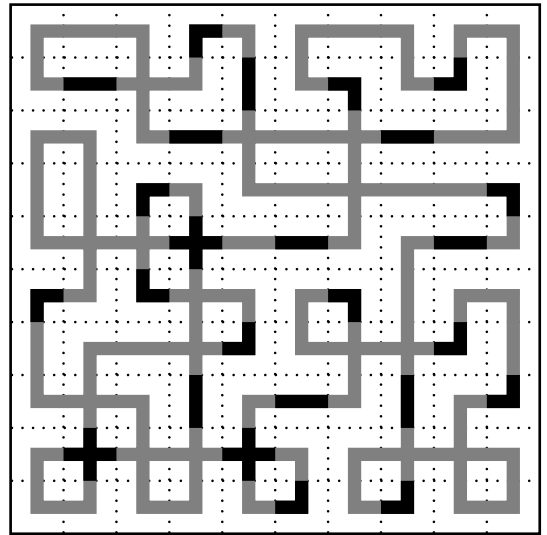

3

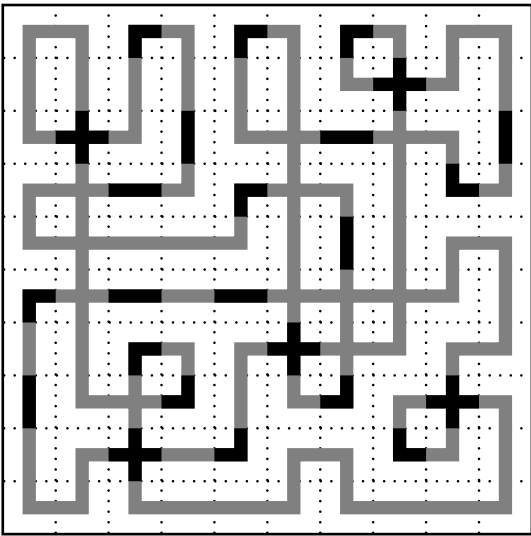

6

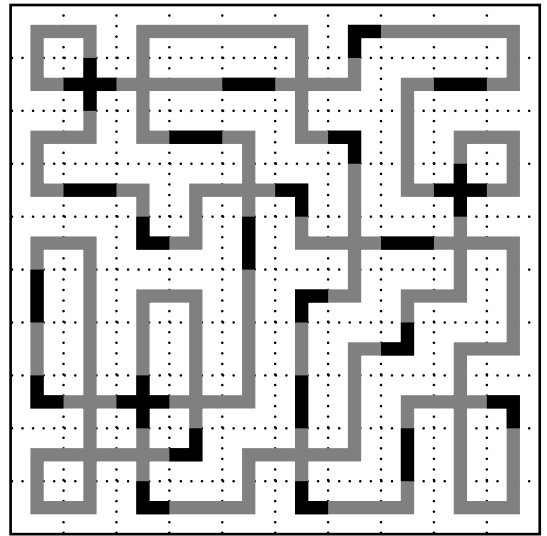



7

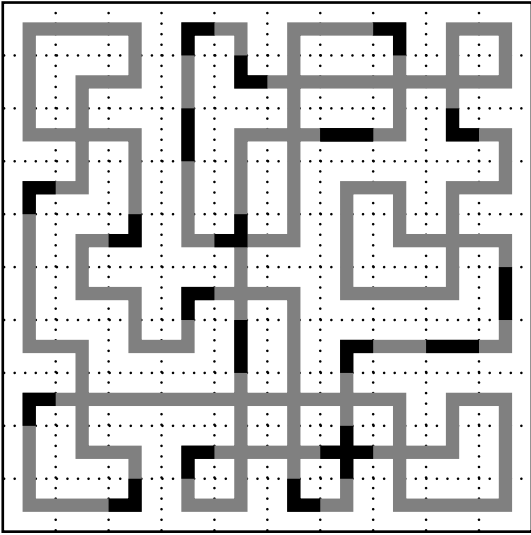

10

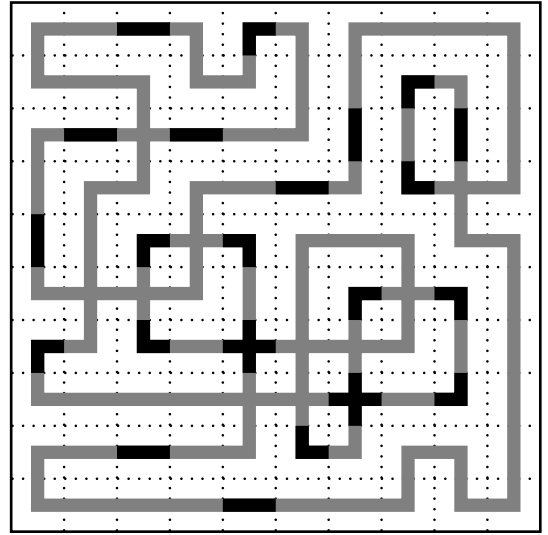

8

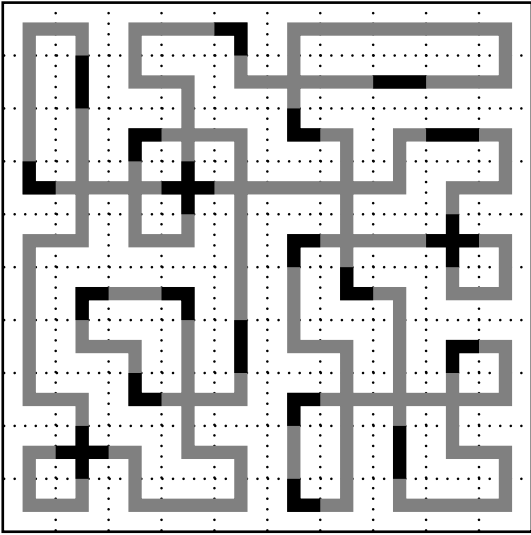

11

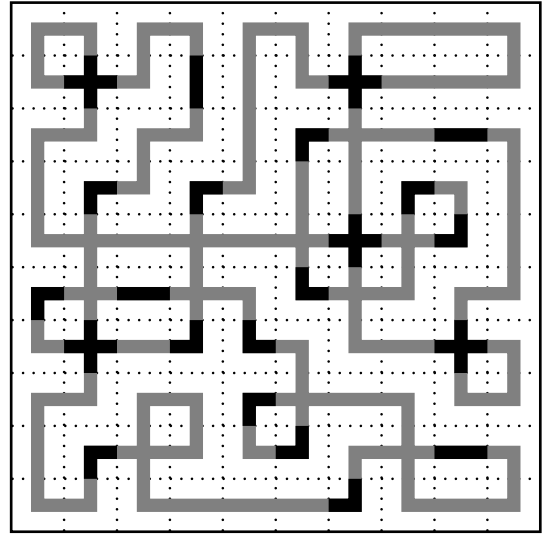

9

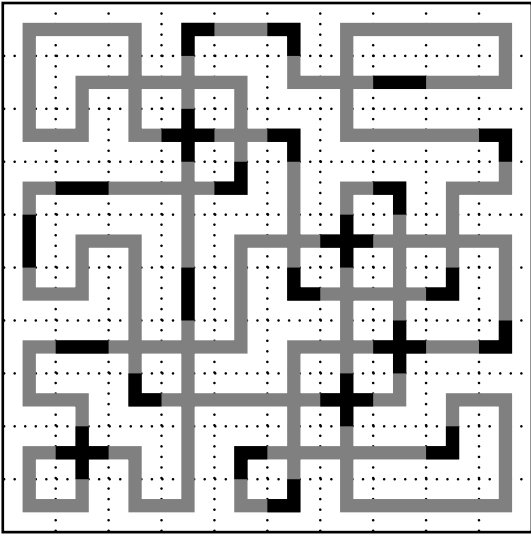

12

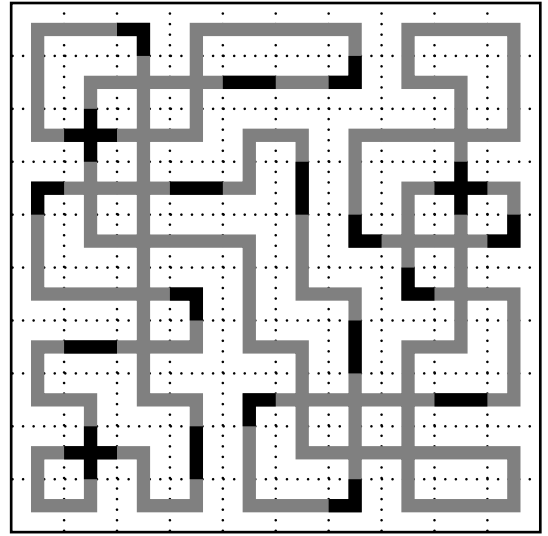

1

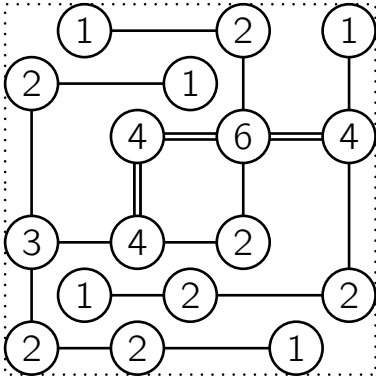

5

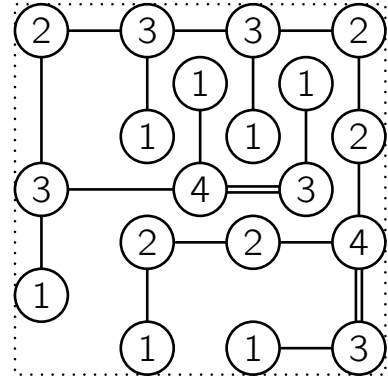

2

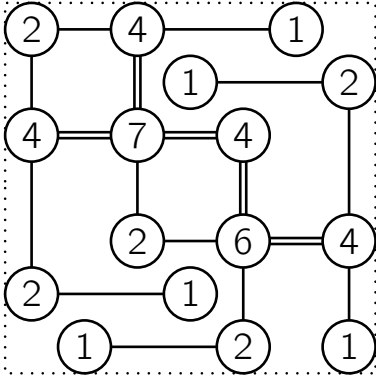

6

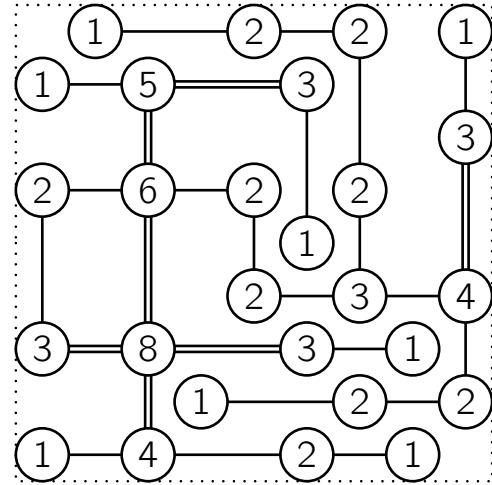

3

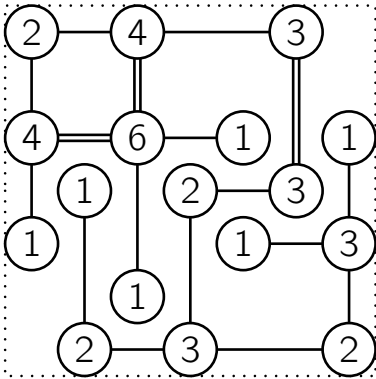

7

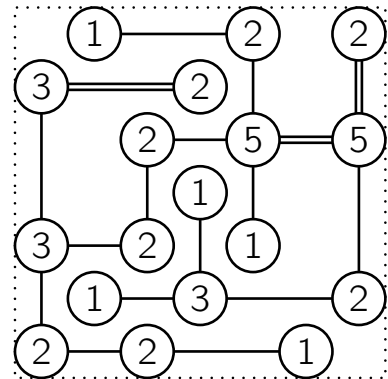

4

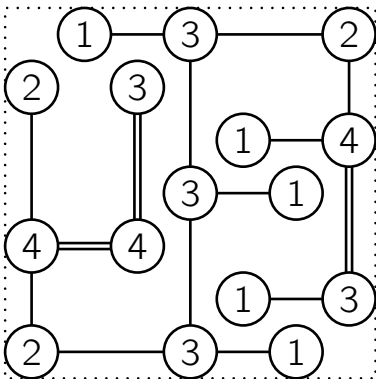

8

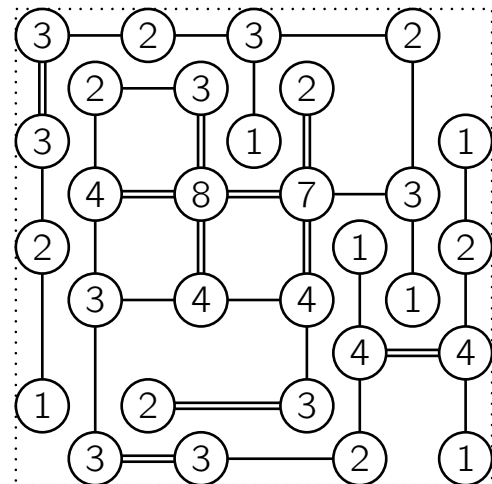

9

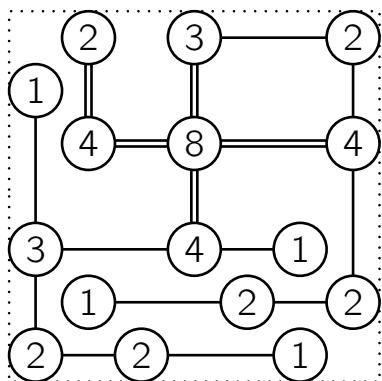

10

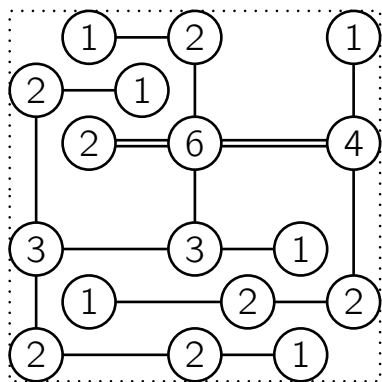

11

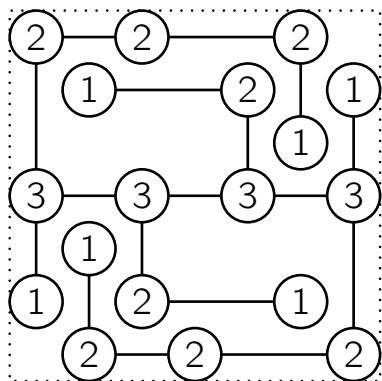

12

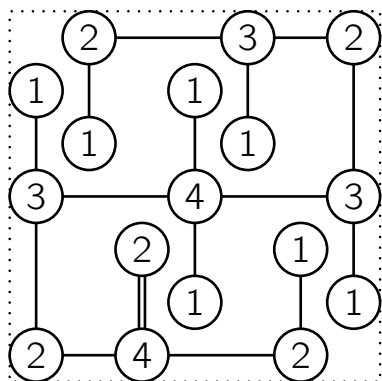

1

5	4		5	
2		4		3
	4	6	3	
2		5		4
	4		6	4

2

5		5	4	4
4	3		4	
4		2		4
	2		2	4
4	4	3		3

3

4		4	6	5
	3			2
4		6		2
2			3	
2	3	4		2

4

	4	4		4
2	2		3	
4				5
	4		4	5
5		5	6	

5

3	3	5		1	3
2			3		4
	3	5	4		5
5		4	2	4	
5		4			4
4	2		4	4	5

6

2	1	2	2	1	2
1	2	2	2	2	1
2	2	2	2	2	2
2	2	2	2	2	2
1	2	2	2	2	1
2	1	2	2	1	2

7

3	6	4	5	4	3
2	5	3	4	3	2
5	6	4	5	4	3
3	8	6	7	5	5
4	5	3	2	2	2
5	2	4	3	2	3

8

5	4		4	5	
4		3		4	3
	5	4	5		5
6		4	5	4	
5	2		4		4
	4	4		3	4

9

	3		3	3	5
4	2	4		4	
	4	6	4		3
5		4	3	4	
3	4		4	5	3
4		3		4	

10

5	3	3	4	5	3
6	4	4	5	4	2
3	4	4	4	5	5
4	4	6	5	6	6
3	5	5	4	3	5
2	4	4	3	2	4

11

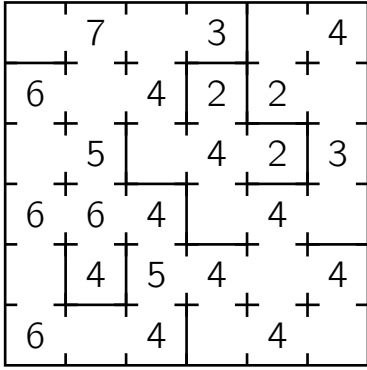

16

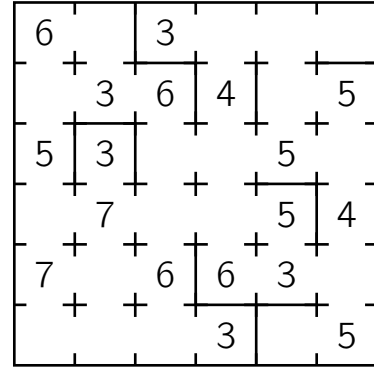

12

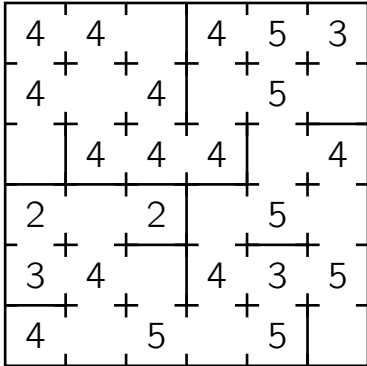

17

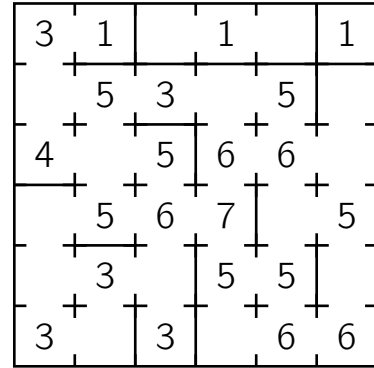

13

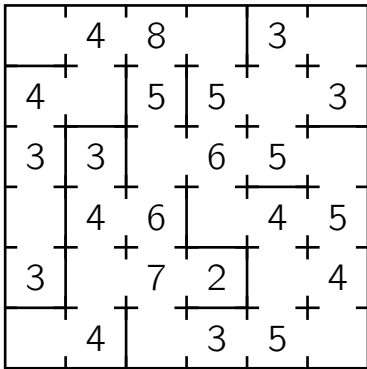

18

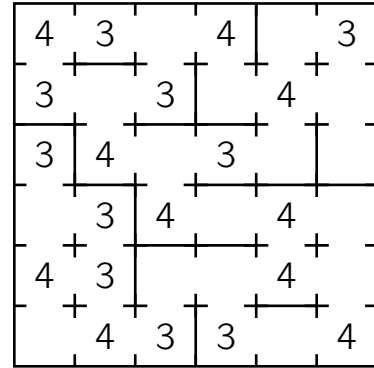

14

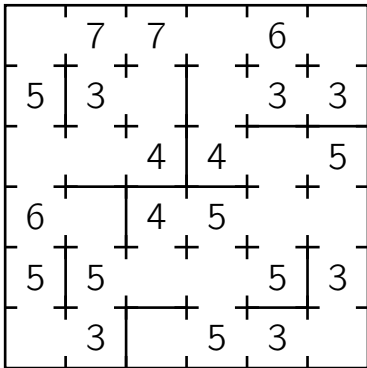

15

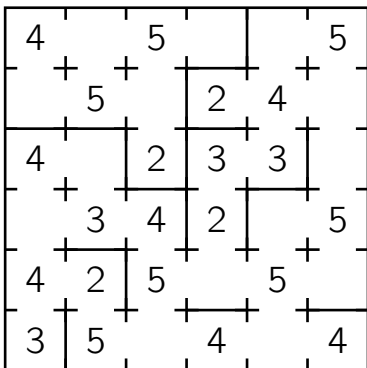

1

3	2	2		3
		2		
	2			
2	2		2	
			3	2

2

	2		2	
2	4			
	4			
2	2		2	3
	2			

3

4				
2		2		
4				
	4			4
	3		2	

4

3			4	
		2		
			4	
	2	2	2	
2		4		

5

		3		
2		2		
2	3		3	2
	2			
2			2	2

6

		3			
		4	2	2	
2			2		
2			2	2	
2			3		6
				4	

7

2			3	2	2
			3		
2				6	2
2					
2	2		2		2
	2				2

8

	2	2		2	
		2		2	
	2			2	
3					
	4		3	2	4

9

3	2				4
			2		
	4		4	2	
				3	5
		2	2		
3					

10

4	5			3	
		3			
			6		
				4	
			2	2	
2		5			

11

	2				2
	2		4	2	
		4		2	2
	2	2			4
	2	3			
2	2			4	3
			3	2	

12

	3			2	2
				2	
		2		2	4
6	4		4	3	6
	2	2			
			3		2

13

			6		
					5
4	3	2	4		3
					8
3		6		3	
			2		

14

					2
			6	2	2
	2		4		
6		3			
	3				4
			4		2
	2			3	

15

					7	
2				5	2	2
	2					7
		2			6	
3		4			8	
	4					
	2			5		2
			5		3	2
6					2	

16

					8	
	6			6		
5				5		
				5		5
						7
2		2			5	
	3		3		3	
2			4		4	2
		2			2	

17

2						
2		6		3	2	4
			2			2
			2		2	
5		6		2	3	4
	7		3			
						6
				9		
	3			4		2

1

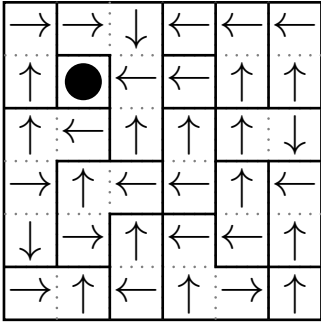

2

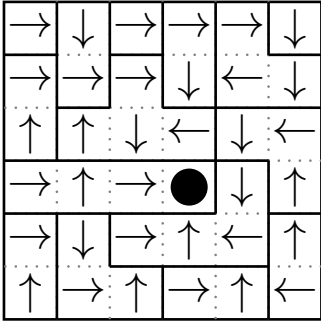

3

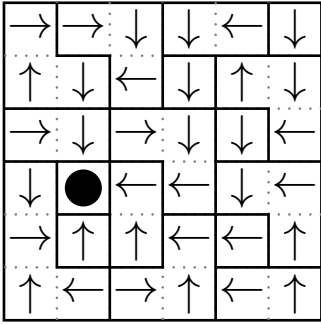

4

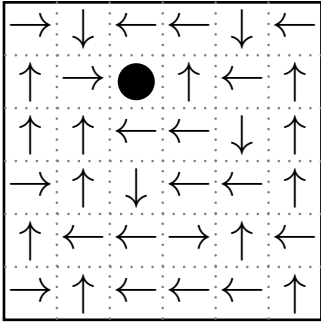

5

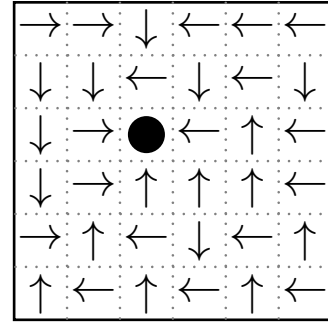

6

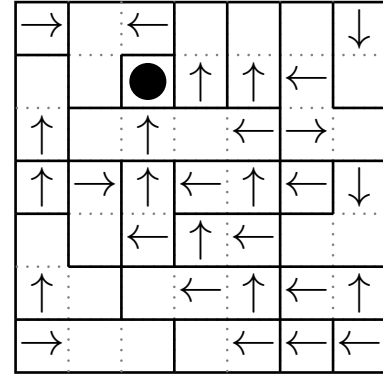

7

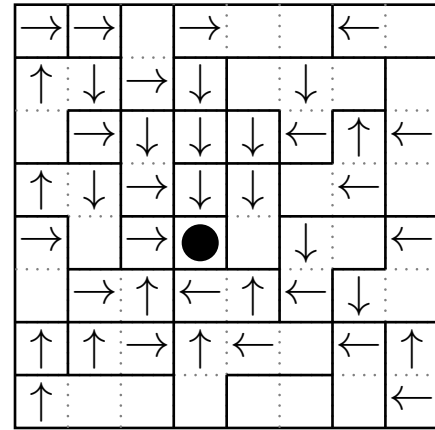

8

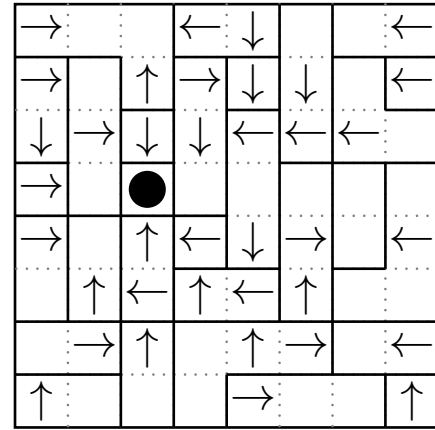



9

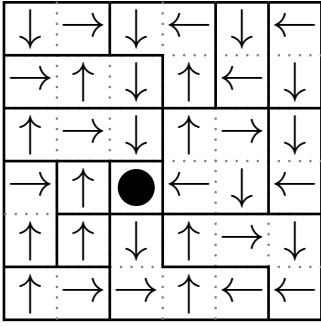

13

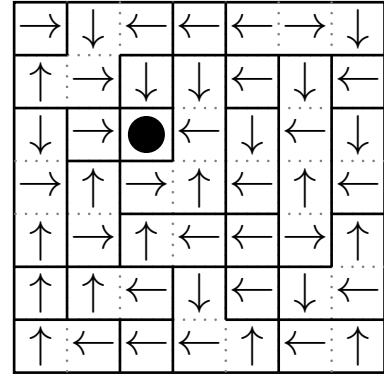

10

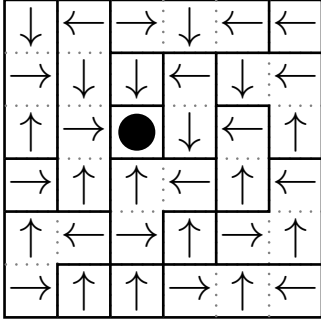

14

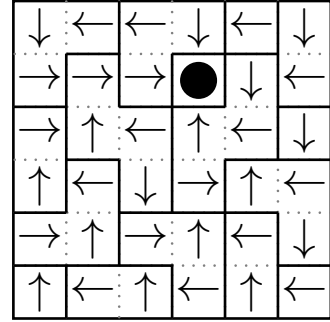

11

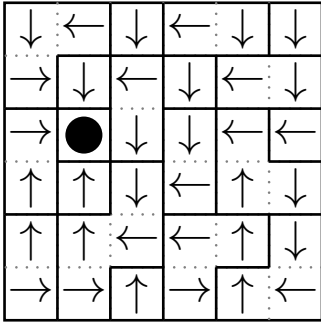

15

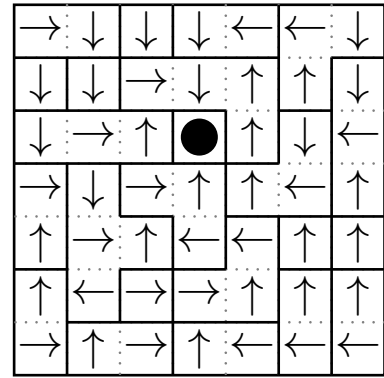

12

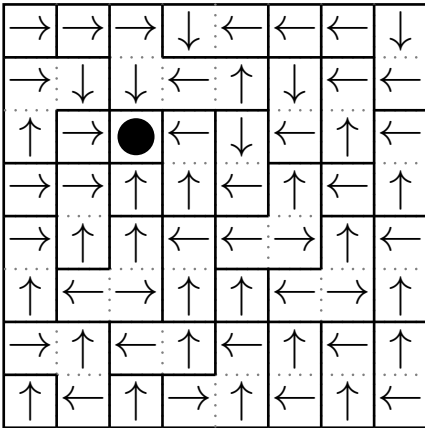

16

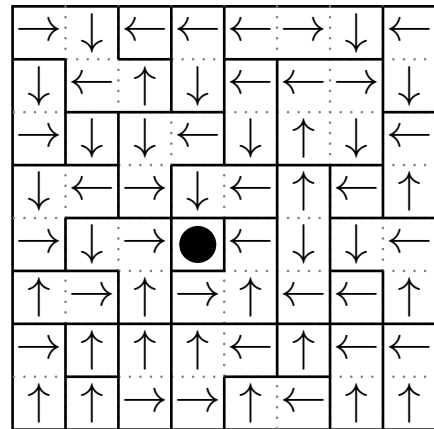

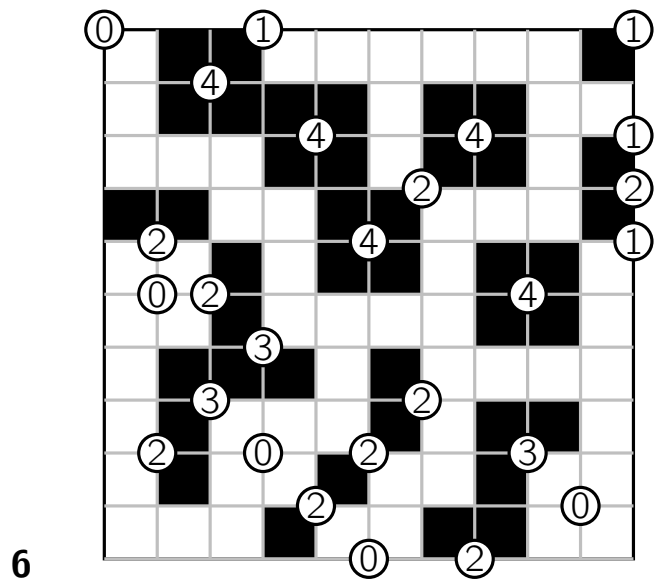
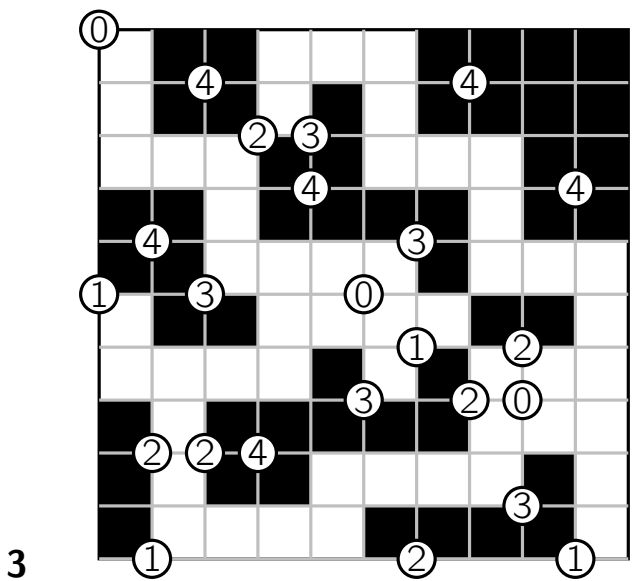
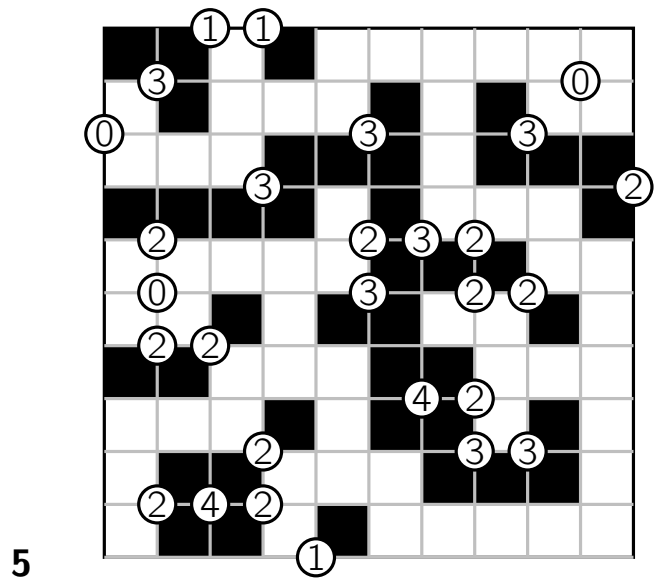
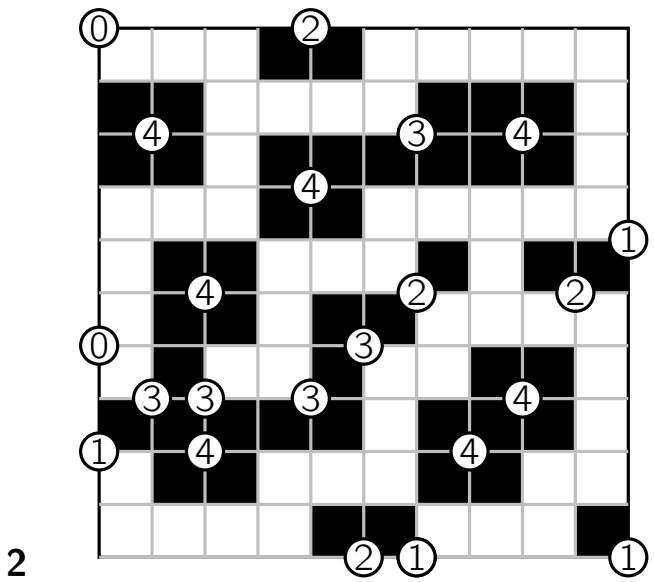
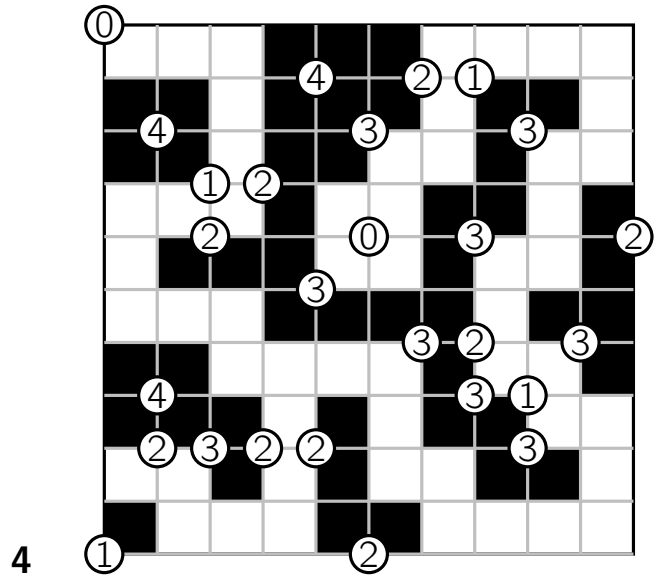
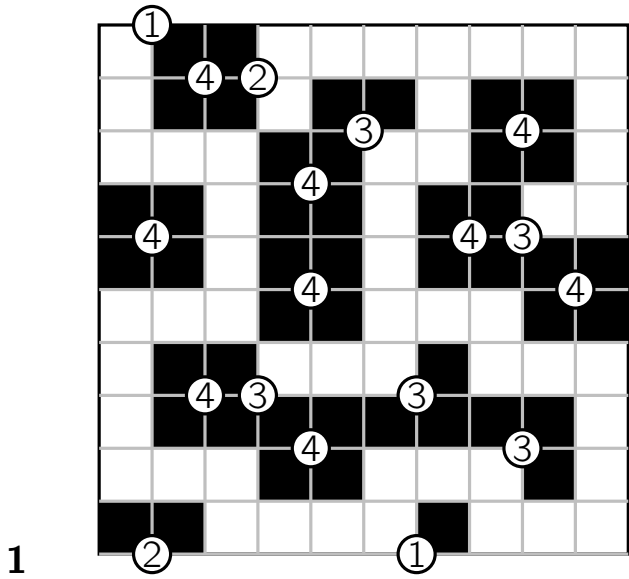

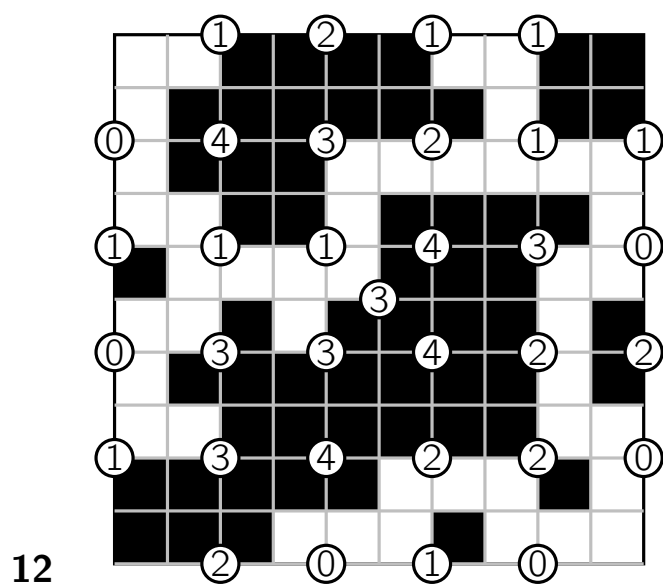
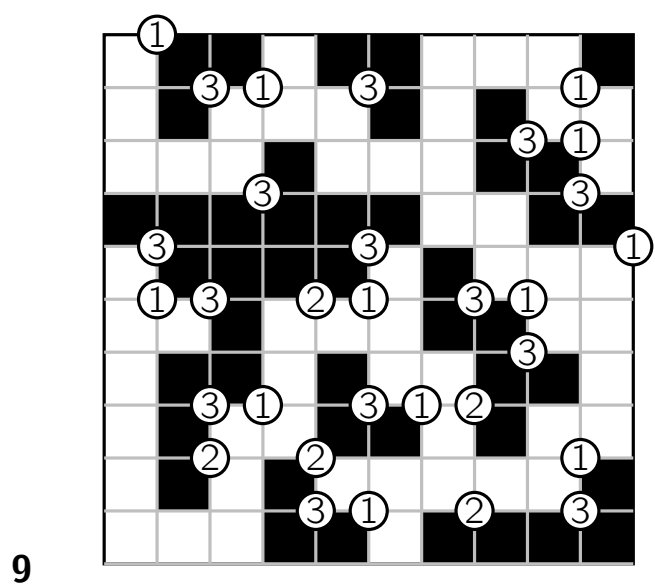
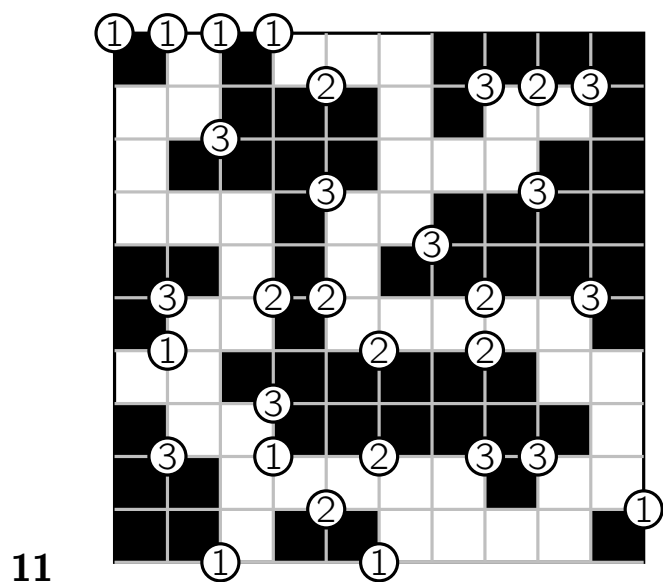
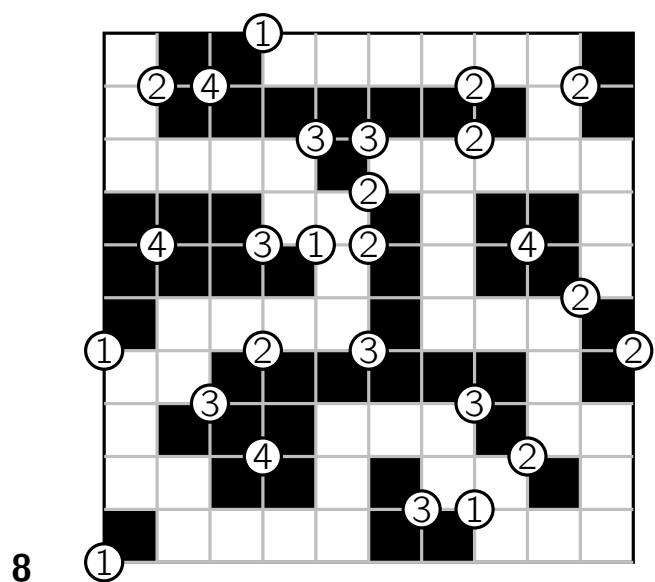
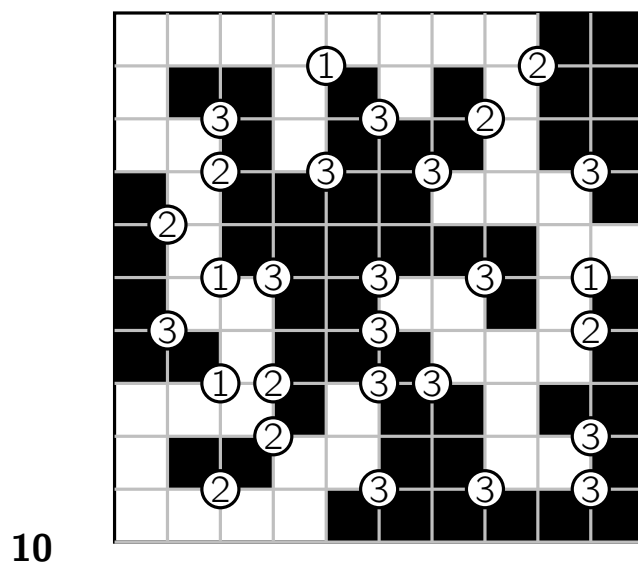
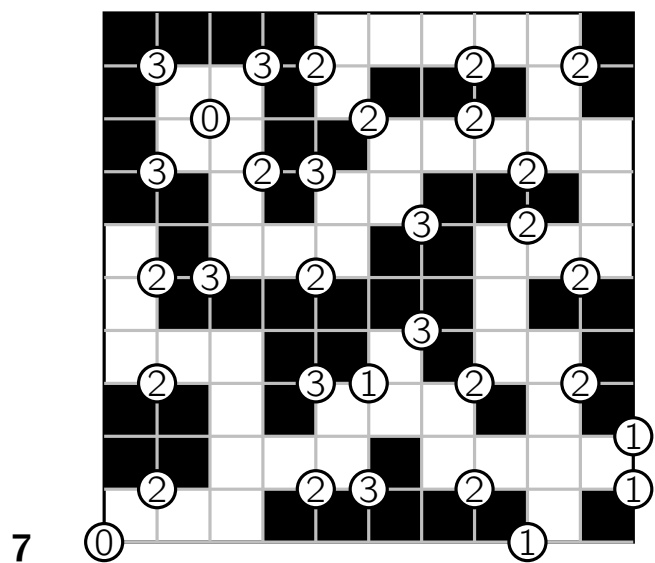

1

2		1	3	
3		2	1	
				1
	1	3		2
	3		2	

2

2		3		
	2			3
1	3			2
3		2		
			2	1

3

3			2	
2		1	3	
	3		1	
		3		
1	2			3

4

2		1	3	
	2			
3			1	2
	3		2	1
	1	3		

5

1	3			2
		3	1	
2				1
		1	2	3
3		2		

6

1	3			2
		2		
3			2	
	2	1		3
2		3		

7

3			1	2
			3	
2	3			1
		1	2	3
		3		

8

3			2	
2			3	1
	3		1	2
		1		
1	2			3

9

3				4
	4	2		
	1		3	
2			1	3
		2		
1	3	4		2

10

3		2		1	4
	3	4			2
	4	1		2	
		3			1
	2				3

11

2	4		1	3	
	1			4	
1					
4		1	3		
	3	2			
			2		4

12

1			2		3
2	4				
		3		1	
4	2				1
	1	4			2
		1		4	

13

4		2		3	
				2	
			1	4	
	4		3		
3	1				4
		3			1

14

2		3			1
			4		2
3		4			
				2	4
	4	2	3	1	

15

1	4				2
2			4		
				2	3
	3				
		4			
4			2	3	1

16

2		3			1
3					4
				3	
	3	4		2	
	2		4	1	3

17

3			4		
1				3	2
4		2			3
			2	4	
2				1	
	4	3		2	
		1	3		4

18

4				2	1
	4			1	2
			3	4	
	2				3
1	3		2		4
			1	3	2
2		4			

19

1	2		4		
4				1	3
		3		4	
2					
	3	2	1	4	
		1		3	4
3				1	2

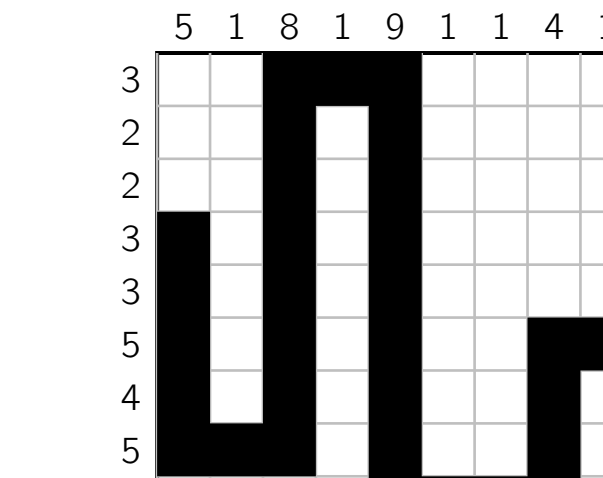
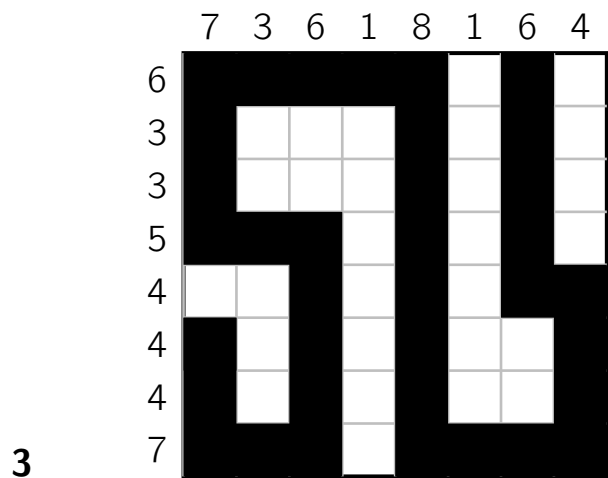
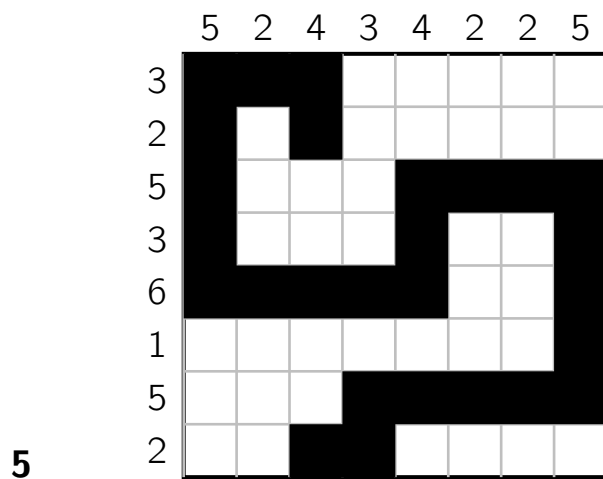
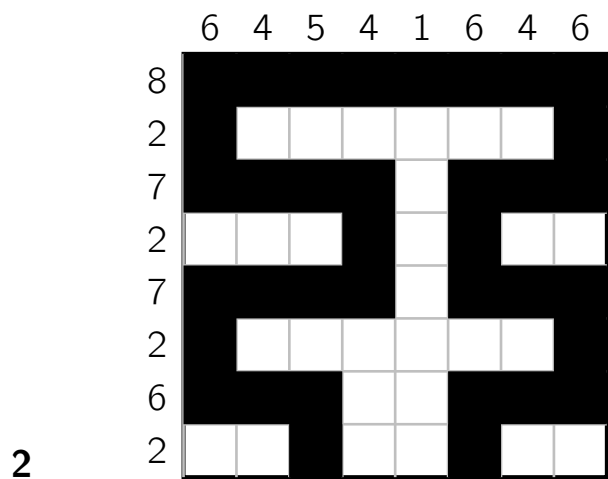
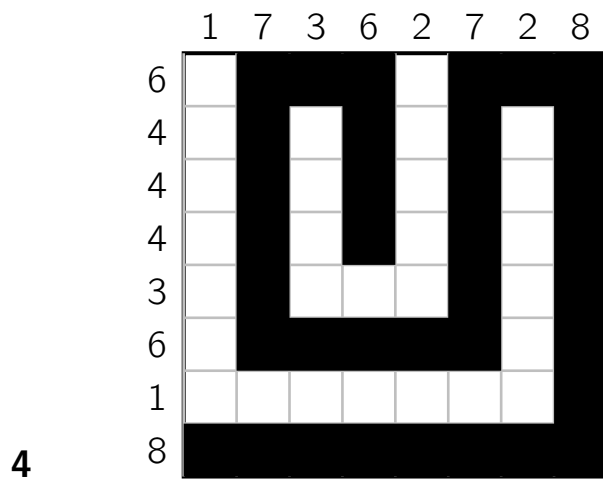
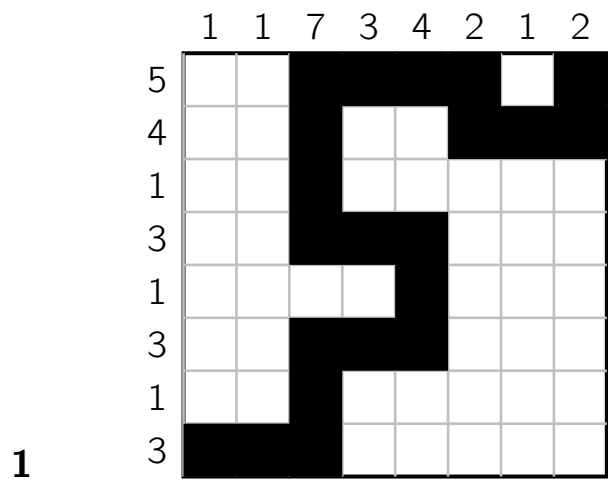

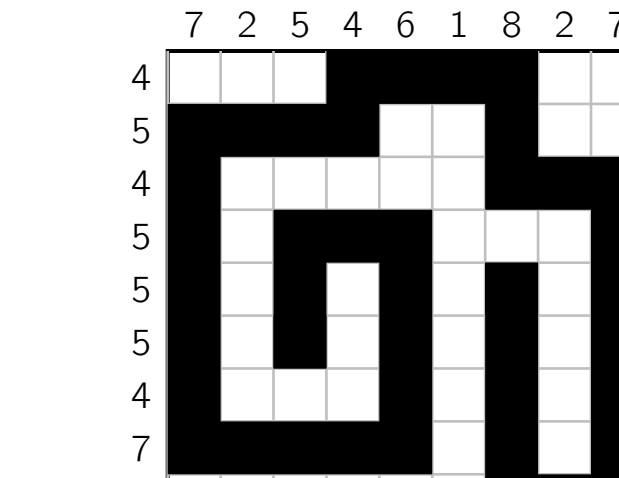
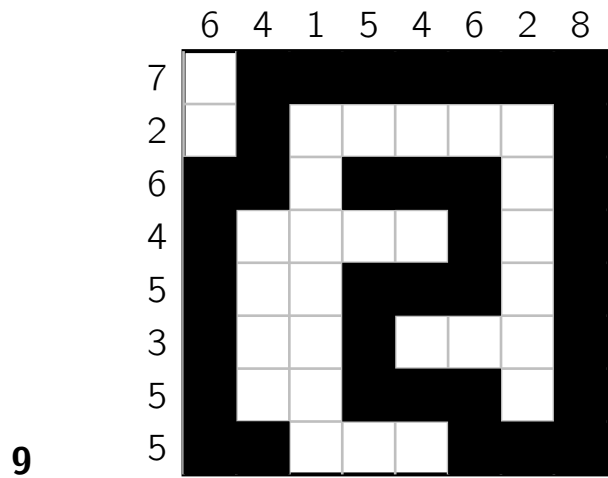
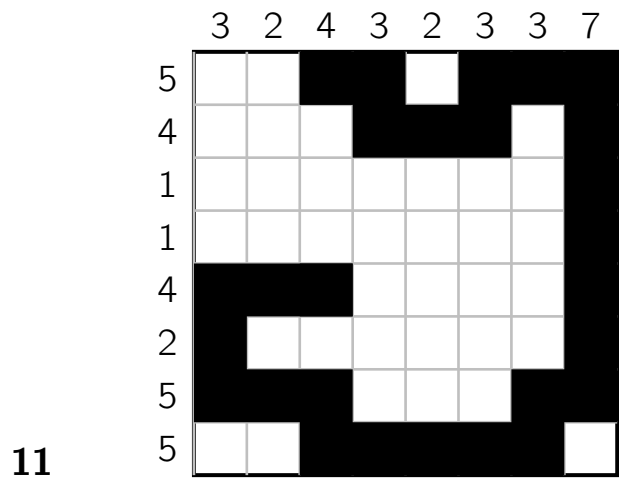
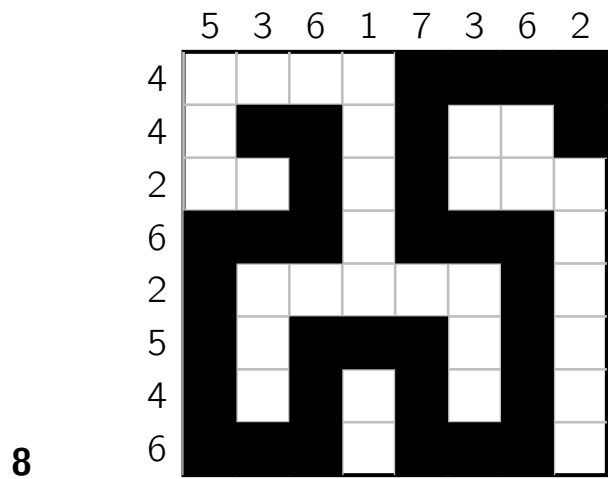
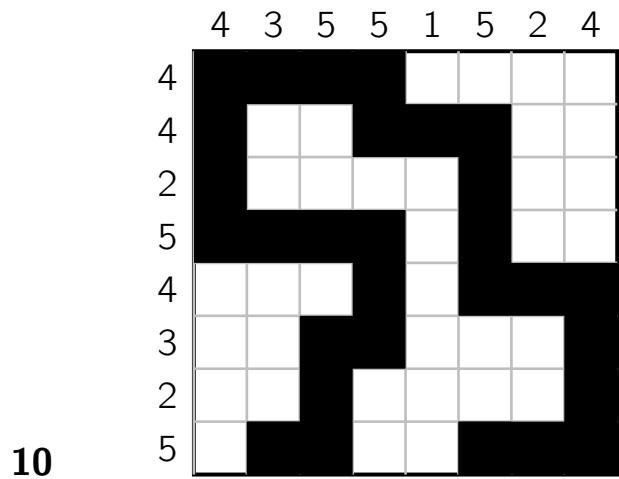
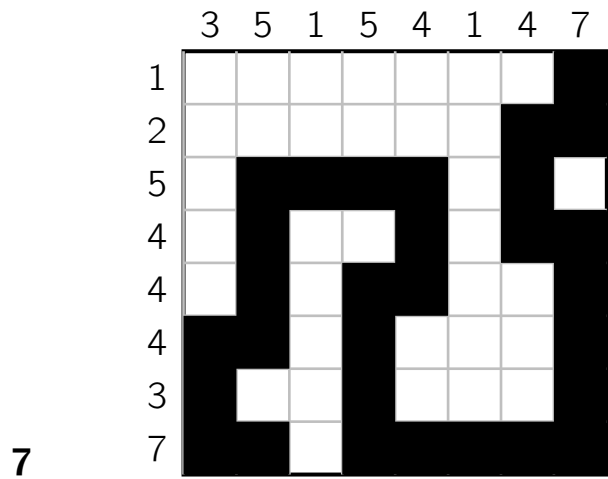





7

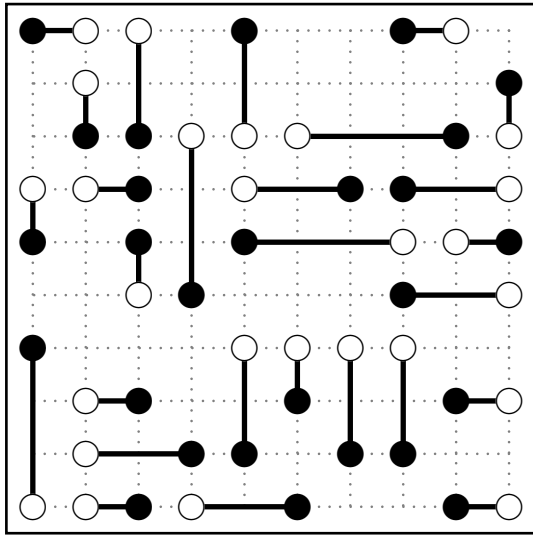

8

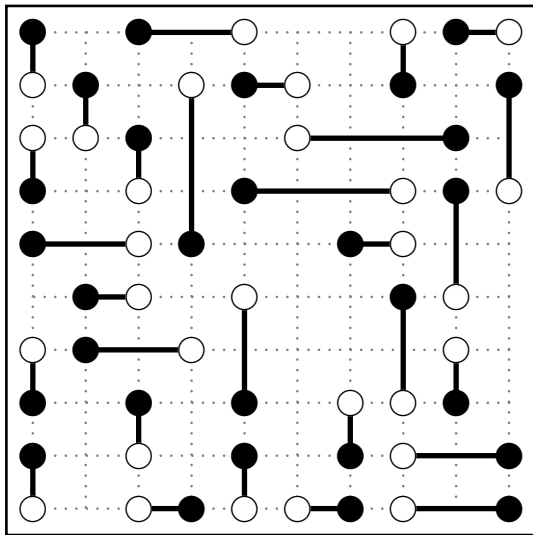

9

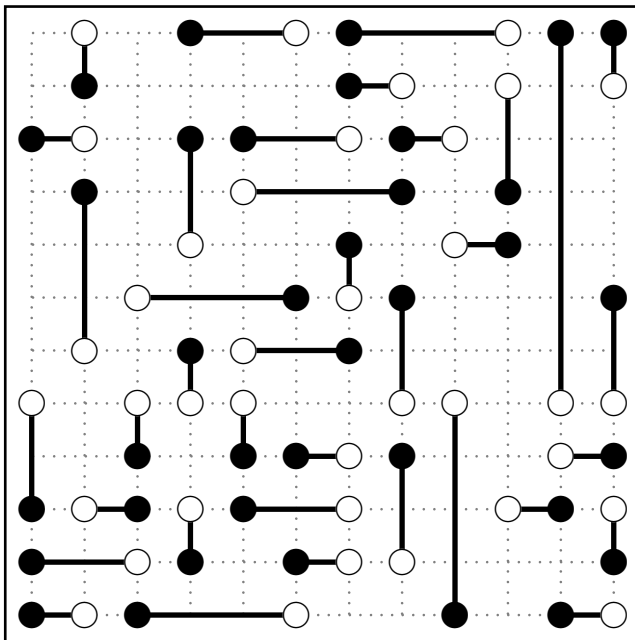

10

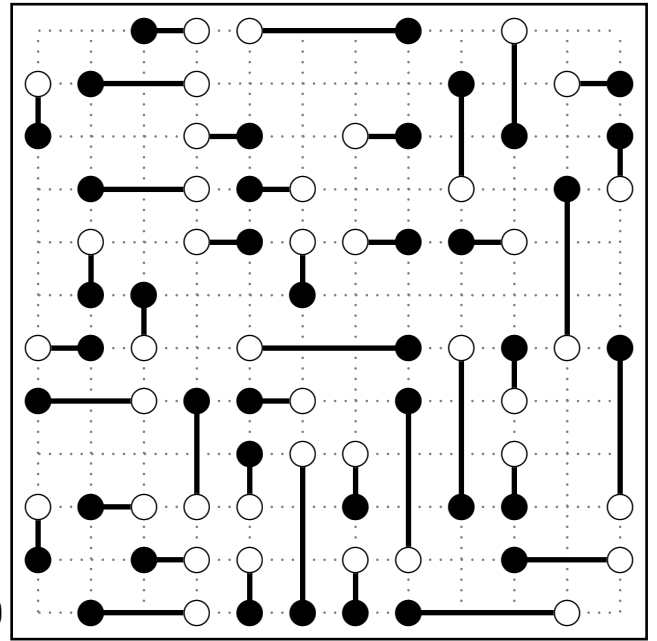

11

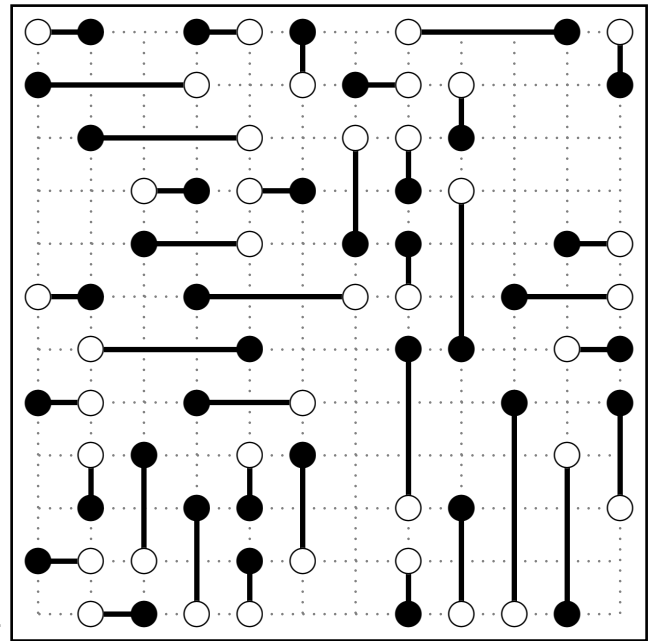

1

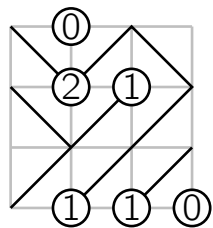

2

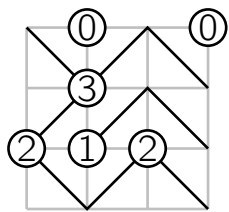

3

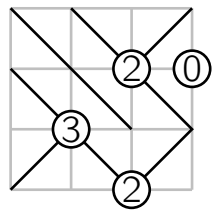

4

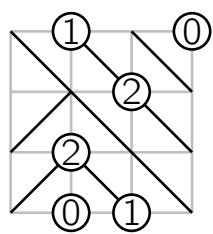

5

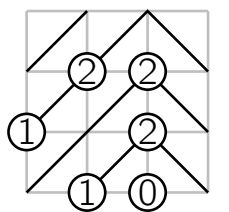

6

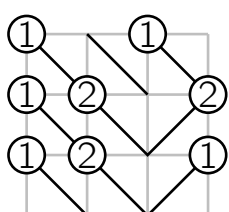

7

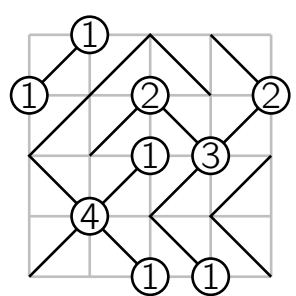

8

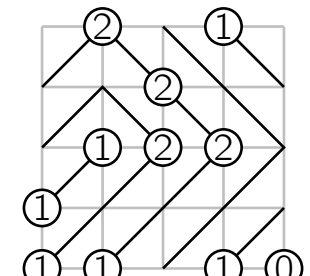

9

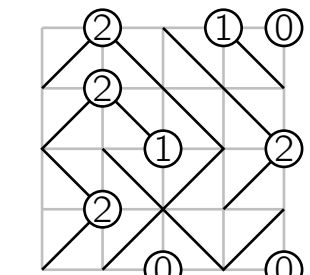

10

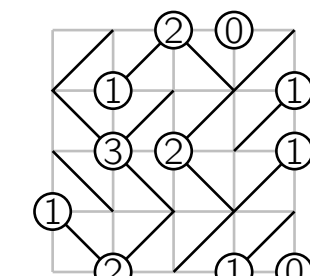

11

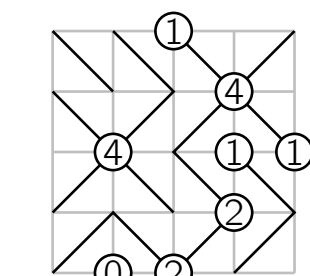

12

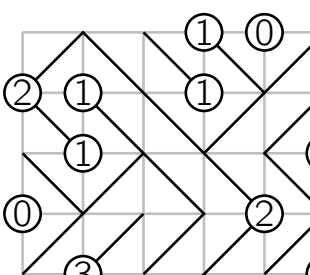

13

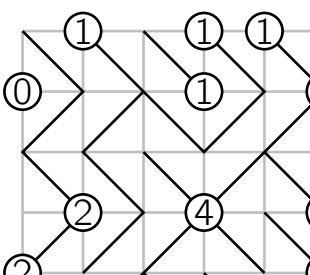

14

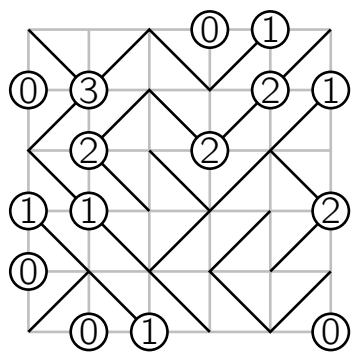

15

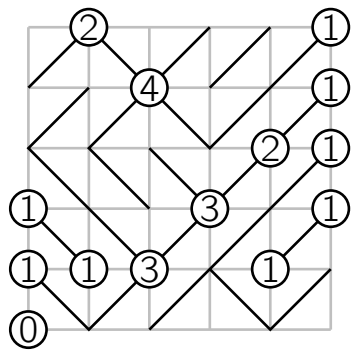

16

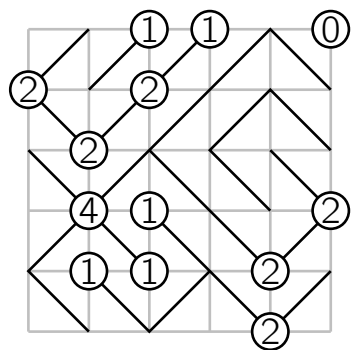

17

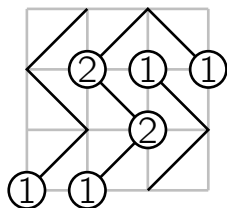

18

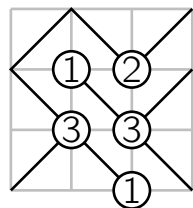

19

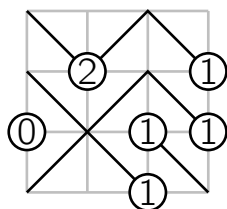

20

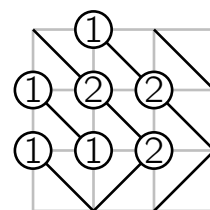

21

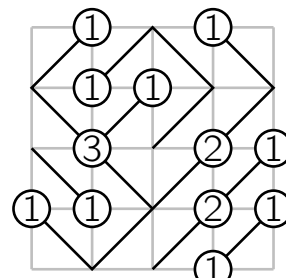

22

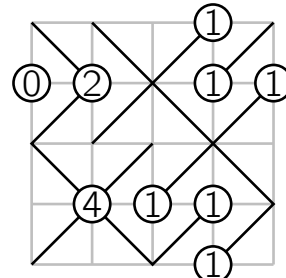

23

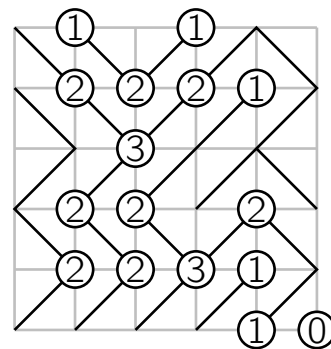

24

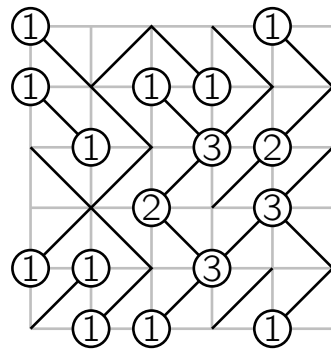

25

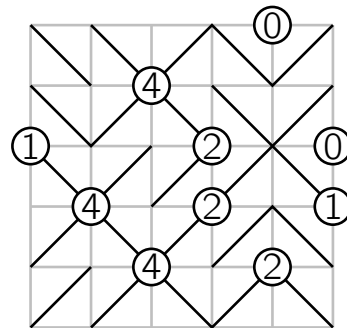

1

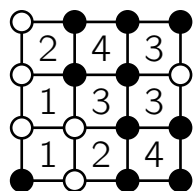

2

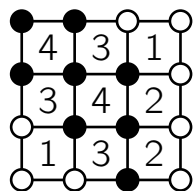

3

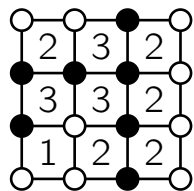

4

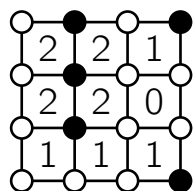

5

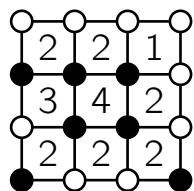

6

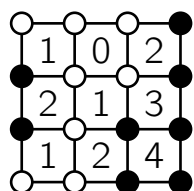

7

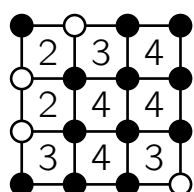

8

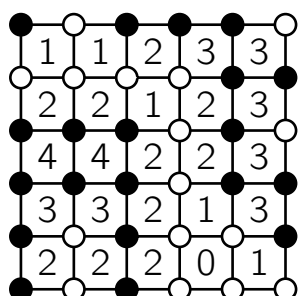

9

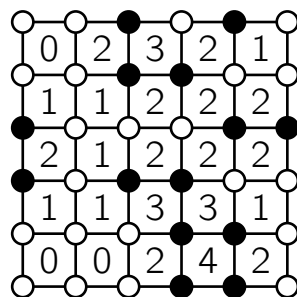

10

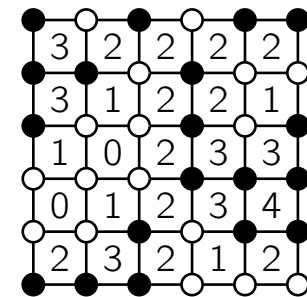

11

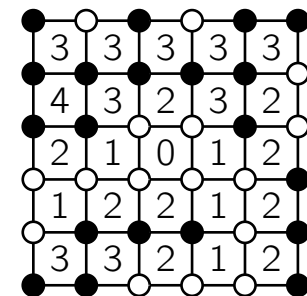

12

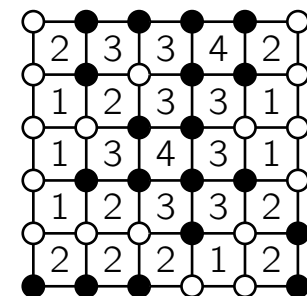

13

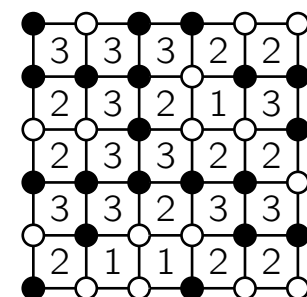

14

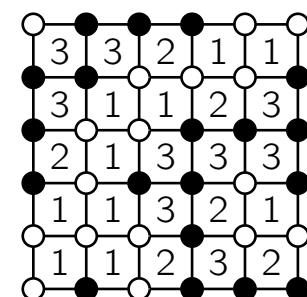

15

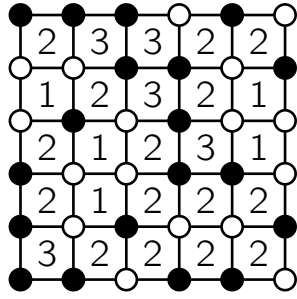

21

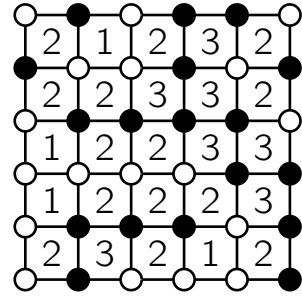

16

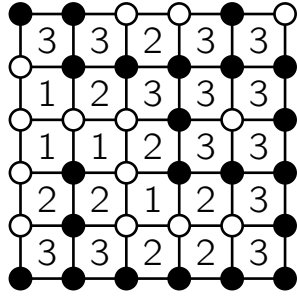

22

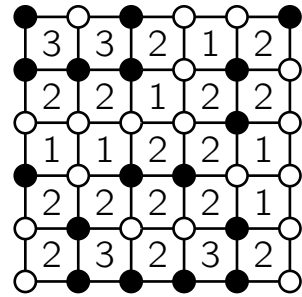

17

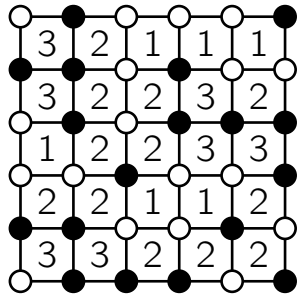

18

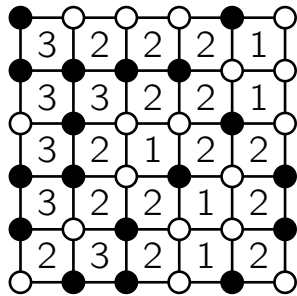

19

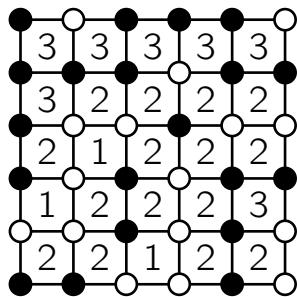

20

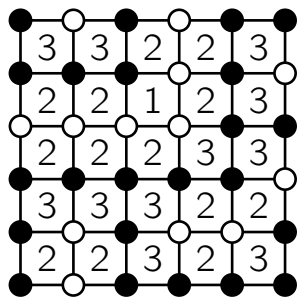

1

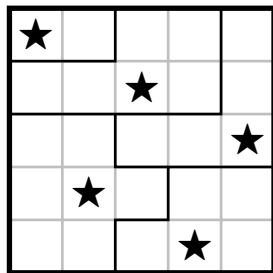

2

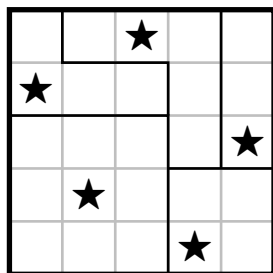

3

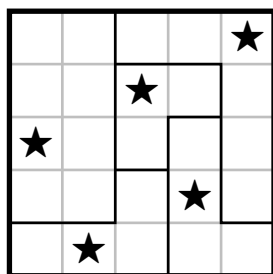

4

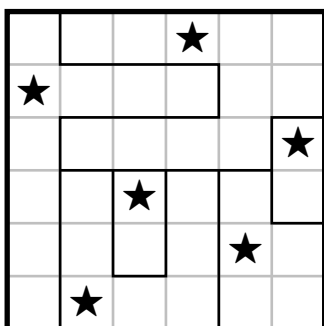

5

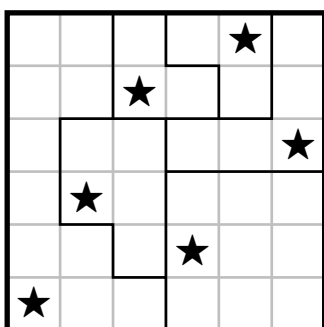

6

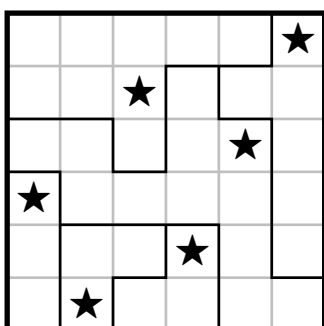

7

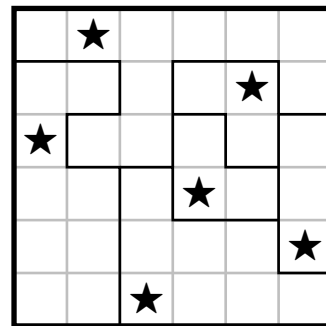

8

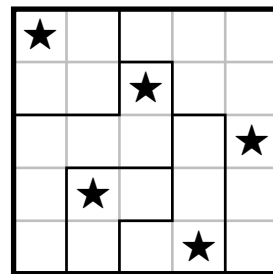

9

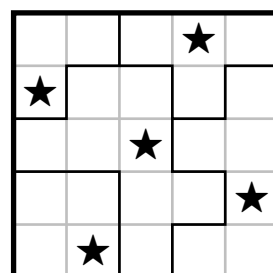

10

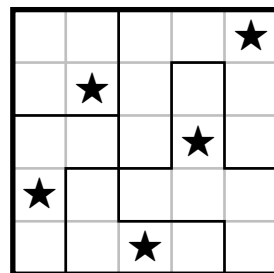

11

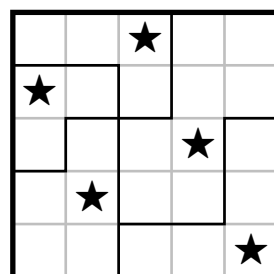

12

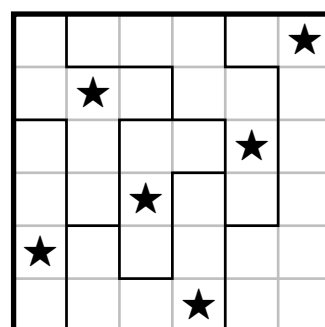

13

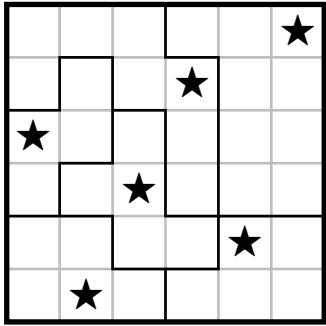

18

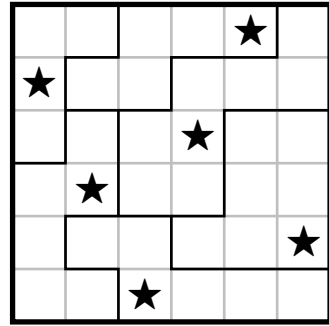

14

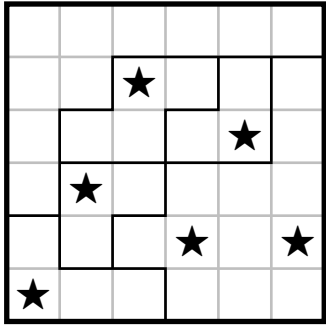

19

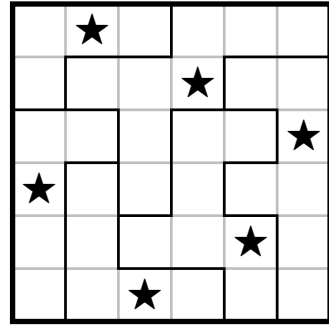

15

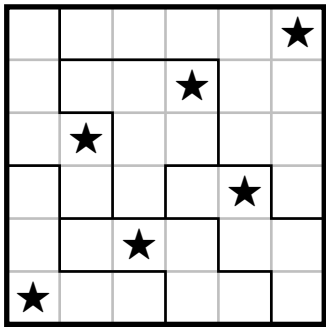

16

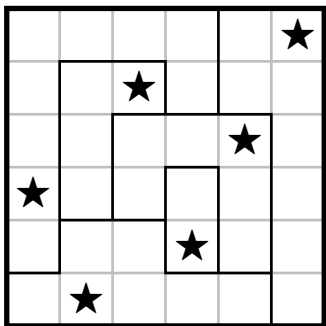

17

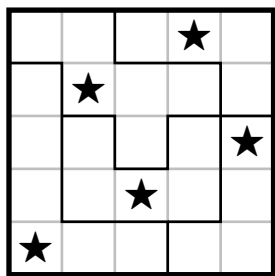

1

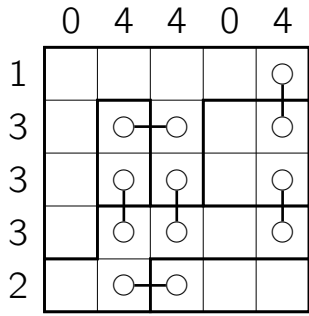

5

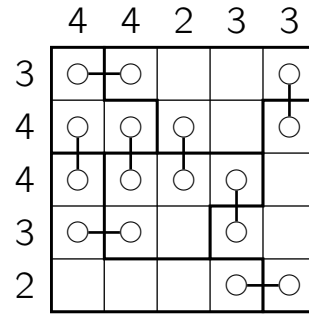

2

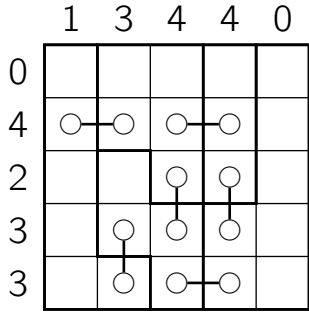

6

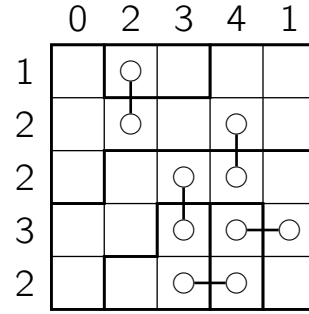

3

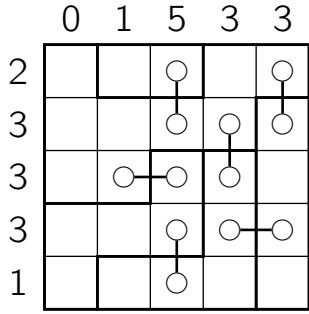

7

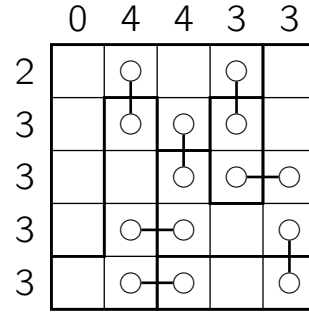

4

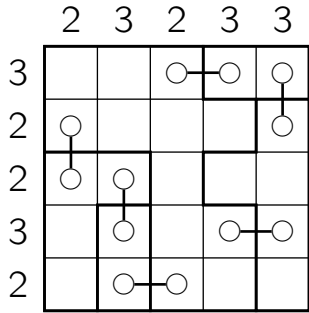

8

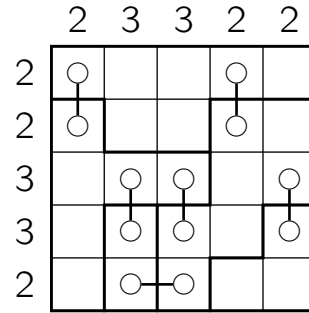

9

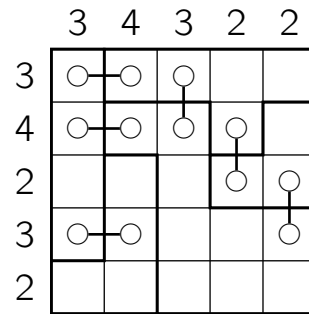



10

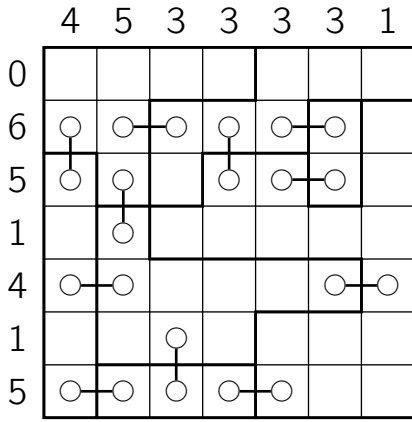

11

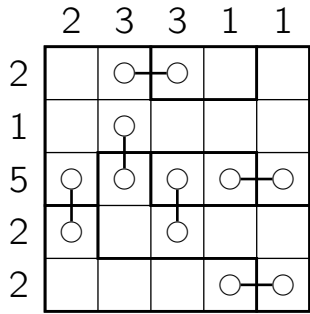

12

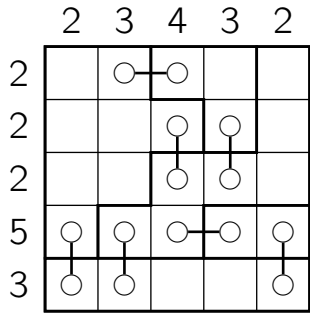

13

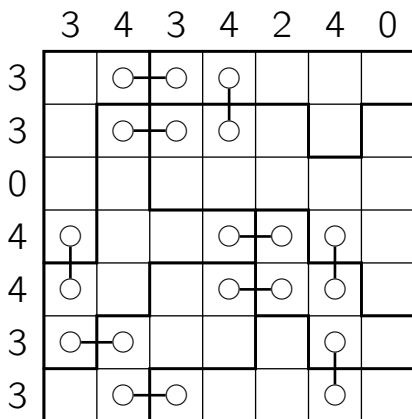

14

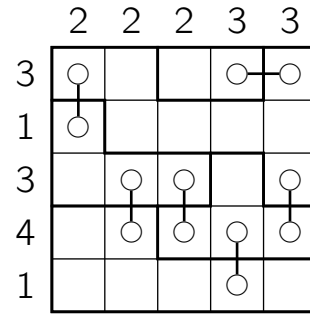

15

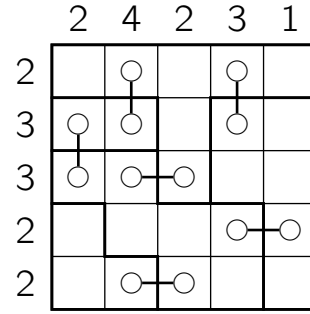

16

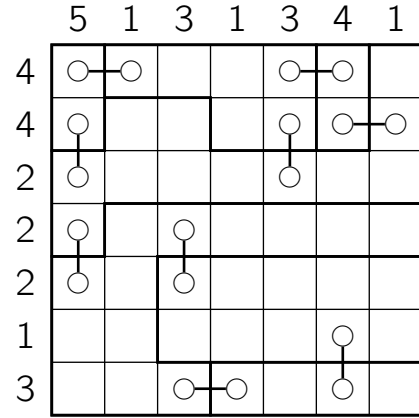

17

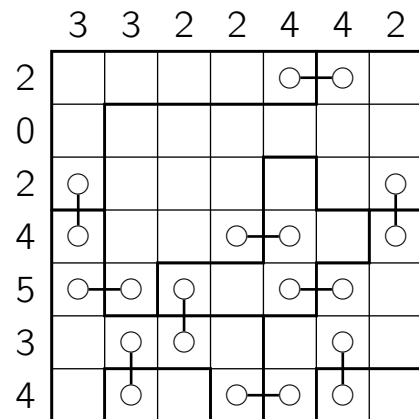

1

4	6	2	3	9	7	8	5	1
7	3	1	5	4	8	2	6	9
9	8	5	2	6	1	3	4	7
8	5	9	6	7	3	4	1	2
3	7	4	9	1	2	6	8	5
2	1	6	8	5	4	9	7	3
5	4	8	7	2	9	1	3	6
1	2	7	4	3	6	5	9	8
6	9	3	1	8	5	7	2	4

4

9	5	6	2	4	3	1	8	7
1	4	2	5	8	7	9	3	6
7	8	3	1	9	6	2	5	4
6	7	9	4	1	8	3	2	5
8	1	5	3	6	2	7	4	9
2	3	4	7	5	9	6	1	8
3	2	8	6	7	4	5	9	1
4	6	1	9	3	5	8	7	2
5	9	7	8	2	1	4	6	3

2

9	2	1	8	5	4	3	6	7
7	5	3	9	6	2	4	1	8
8	4	6	1	7	3	9	5	2
5	1	2	4	3	8	7	9	6
6	3	8	7	9	1	5	2	4
4	9	7	5	2	6	8	3	1
3	8	4	6	1	9	2	7	5
2	6	5	3	4	7	1	8	9
1	7	9	2	8	5	6	4	3

5

7	9	3	4	1	8	5	2	6
4	8	2	6	3	5	7	9	1
5	6	1	7	9	2	4	3	8
6	3	4	2	5	1	9	8	7
1	2	5	9	8	7	6	4	3
8	7	9	3	6	4	2	1	5
2	4	8	5	7	3	1	6	9
9	1	7	8	4	6	3	5	2
3	5	6	1	2	9	8	7	4

3

8	6	2	4	3	7	9	5	1
3	7	5	2	9	1	8	6	4
1	4	9	5	6	8	7	2	3
6	3	7	8	1	4	2	9	5
4	5	8	9	2	6	1	3	7
2	9	1	3	7	5	6	4	8
9	8	6	7	4	3	5	1	2
5	2	3	1	8	9	4	7	6
7	1	4	6	5	2	3	8	9

6

9	5	6	2	4	3	1	8	7
1	4	2	5	8	7	9	3	6
7	8	3	1	9	6	2	5	4
6	7	9	4	1	8	3	2	5
8	1	5	3	6	2	7	4	9
2	3	4	7	5	9	6	1	8
3	2	8	6	7	4	5	9	1
4	6	1	9	3	5	8	7	7
5	9	7	8	2	1	4	6	3

7

7	1	6	8	2	9	4	3	5
4	3	2	5	1	7	9	6	8
8	5	9	6	3	4	7	1	2
5	9	8	1	7	3	2	4	6
3	2	1	4	9	6	8	5	7
6	7	4	2	5	8	3	9	1
9	8	7	3	6	5	1	2	4
1	6	3	7	4	2	5	8	9
2	4	5	9	8	1	6	7	3

10

3	7	9	1	2	4	6	8	5
5	6	2	8	9	7	3	1	4
8	1	4	5	3	6	9	7	2
6	9	7	3	1	5	4	2	8
4	3	1	7	8	2	5	6	9
2	8	5	6	4	9	7	3	1
7	4	6	2	5	1	8	9	3
9	2	8	4	7	3	1	5	6
1	5	3	9	6	8	2	4	7

8

7	1	5	2	3	6	9	8	4
8	3	9	7	4	1	5	6	2
2	4	6	9	5	8	3	7	1
1	7	3	8	9	5	2	4	6
5	6	4	1	2	3	8	9	7
9	8	2	4	6	7	1	3	5
6	9	8	5	1	4	7	2	3
3	2	1	6	7	9	4	5	8
4	5	7	3	8	2	6	1	9

11

8	9	6	7	4	3	1	2	5
3	2	1	5	9	6	8	4	7
7	5	4	2	8	1	9	3	6
2	6	7	6	1	8	5	9	4
1	4	5	9	3	2	6	7	8
9	6	8	4	7	5	3	1	2
4	7	3	8	6	9	2	5	1
6	1	2	3	5	4	7	8	9
5	8	9	1	2	7	4	6	3

9

2	7	1	5	8	4	3	6	9
4	5	9	3	6	1	7	8	2
6	3	8	2	7	9	5	4	1
1	4	3	9	5	2	6	7	8
9	6	5	8	1	7	4	2	3
7	8	2	4	3	6	1	9	5
3	1	4	6	2	8	9	5	7
5	2	6	7	9	3	8	1	4
8	9	7	1	4	5	2	3	6

12

1	7	6	3	4	5	9	8	2
4	8	2	9	6	1	3	5	7
5	9	3	7	8	2	1	6	4
3	1	7	8	2	6	4	9	5
8	4	9	5	1	7	2	3	6
6	2	5	4	3	9	8	7	1
2	3	8	6	5	4	7	1	9
9	5	1	2	7	8	5	4	3
7	5	4	1	9	3	6	2	8

1

			1		
1		1	4	2	1
3	2		2		
2	4	3	4	2	1
	3	4	3		
	2	3	2		

2

1	3	2			1
	2	4	2	3	2
1		2		2	
3	2	4	3	4	1
2		3	4	3	
1		2	3	2	

3

	1	2	3	2	
			2	4	1
1		1		2	
3	2	3	2	4	1
2				2	
1		1	2	3	1

4

			2	3	1
		2	4	2	
1	2	4	3		1
		3	2		2
		2		2	3
1	2	3	2	3	2

5

1			1	2	
3	2	1		3	2
2				2	3
3	2				2
2	4	2		2	3
	2	3	2	3	2

6

1			1	2	
3	1			3	2
2		1	2	4	3
3	2			3	2
2	4	2		2	
	2	3	2	3	1

7

		2	1				
	1	3				1	
	2			1		3	2
	1	4	2	4	3	4	3
1		1		3	4	3	2
3	2		1	4	2		
2	4	2		2			
	2	3	2	3	2	1	

8

2	3	2	3	2	1		1
3	2		1				2
2				1		2	3
3	2			3	2	4	2
2	4	2	3	2		2	
	1		2			1	
		1	4	2	1		
			1				

9

1	3	2		1			
	2	3	2	3			
1				2			
2		1		3	2		
3	2	4	2	4	3	2	1
2		2		1			
1		3	2		2	3	1
		2	3	2	3	2	

10

			1		1
		2	3		2
		3	4	2	3
1		2	3		2
3	2		2		1
2	3	2	3	1	

11

		1	3	2	
1			2	4	2
2		1		2	3
3	2	3			2
1		2		2	3
	1	3	2	3	2

12

			1	3	2
	1			2	3
1	4	3	1		2
	3	2		2	3
	2		2	4	2
1	3	2	3	2	

13

	2	3	2	3	2
2	3	2		2	3
1			1		2
		2	4	2	3
	2	4	2		1
1	3	2			

14

	1		1	3	1
1	4	1		2	
	2			3	2
1	4	3	2	4	3
	3	2		3	2
1	2		1	2	

15

			1		1		
	2	3	4	3	4	1	
1	3	4	3	4	3		1
		1		3	4	2	3
			2	4	2		1
1			3	2			
3	2		2		1		
2	3	2	3	2	3	1	

16

		1	2	3	2	3	2
1				2		2	3
3	2	3	2	3			2
2		2		2		1	3
1		1		3	2		1
			1	4	3	2	
		1		2		1	
	1	3	2	3	1		

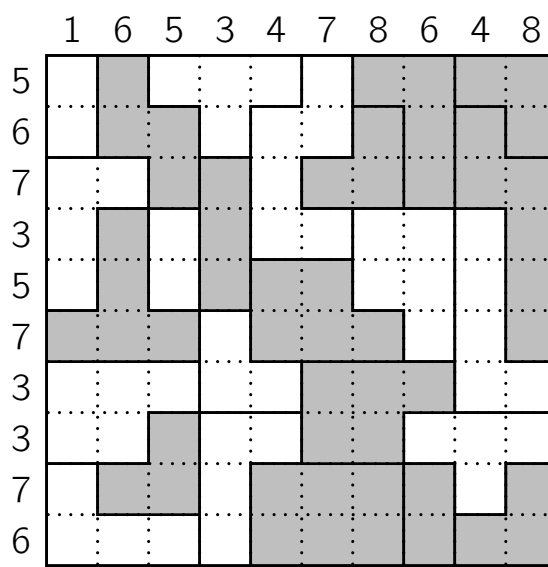
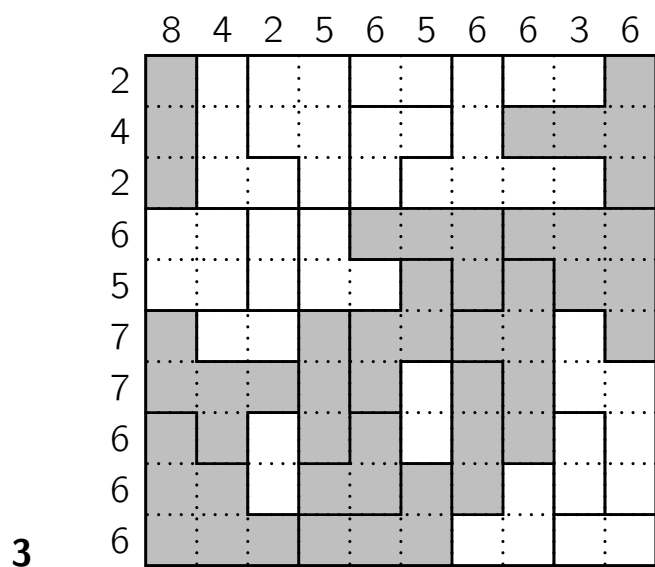
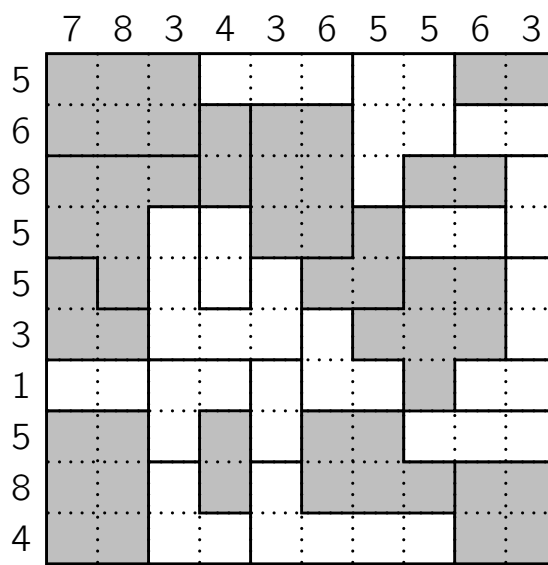
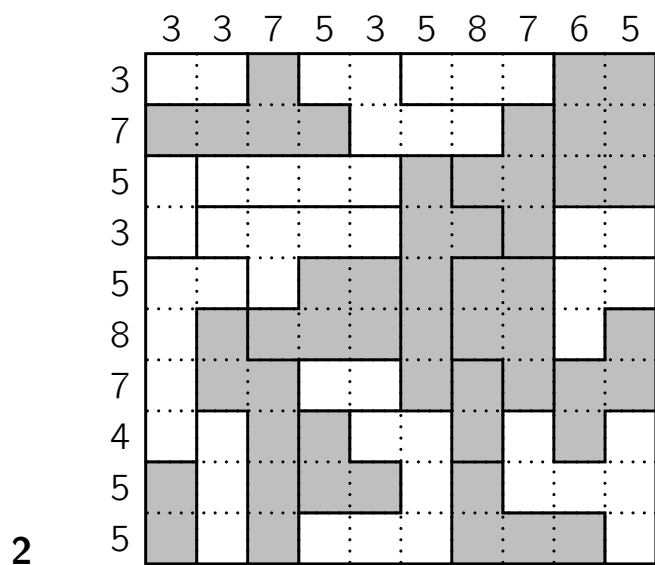
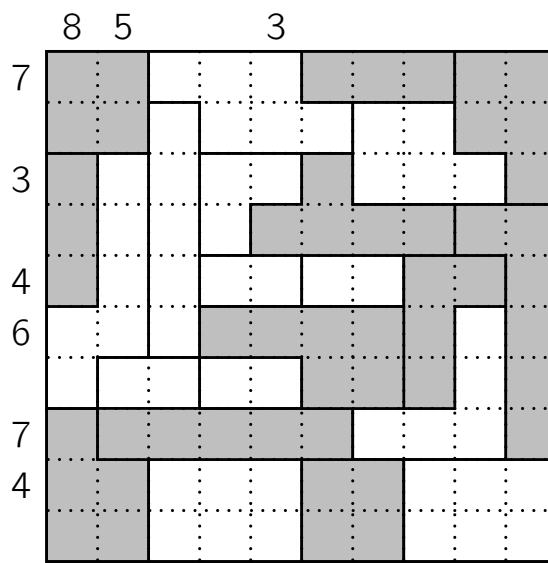
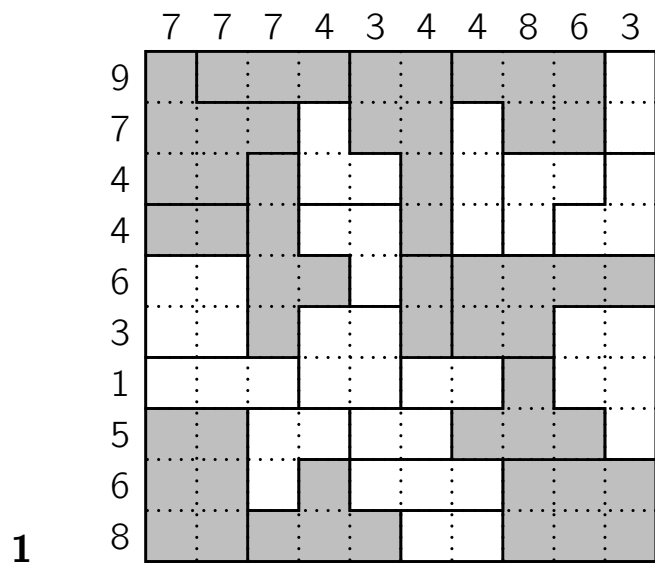

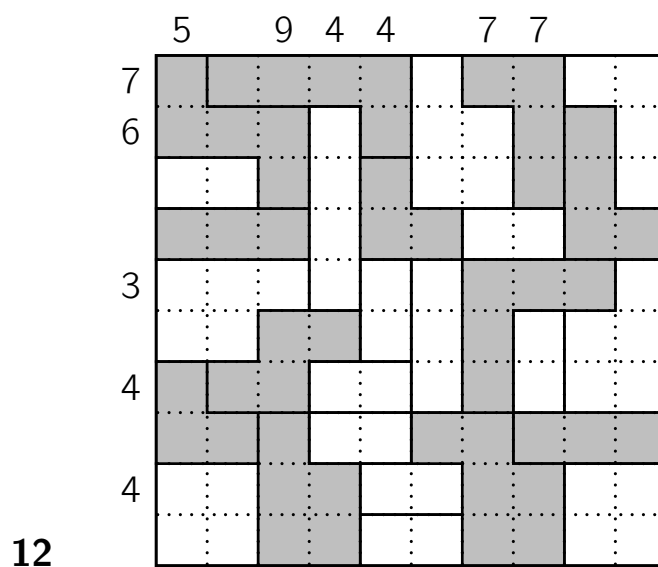
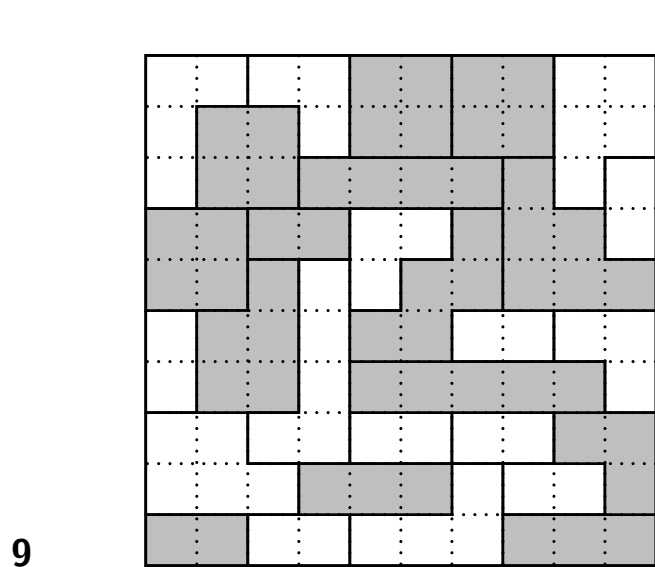
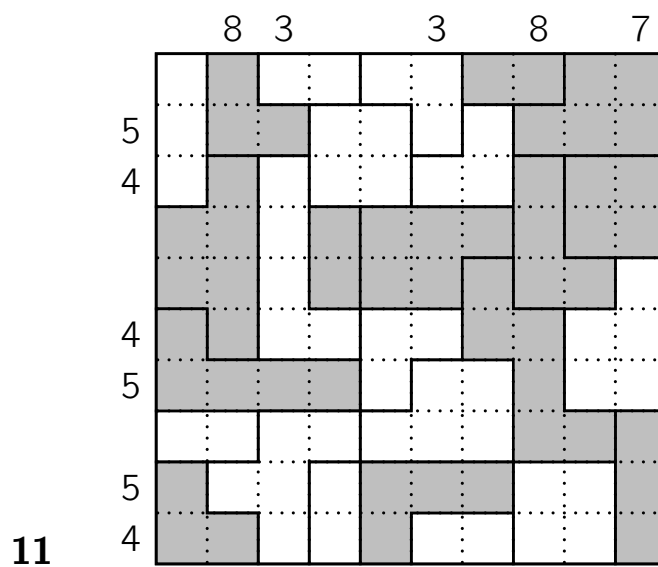
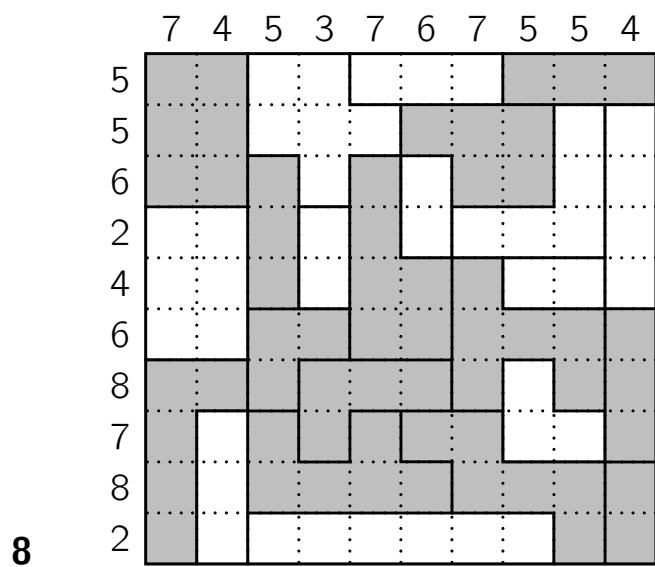
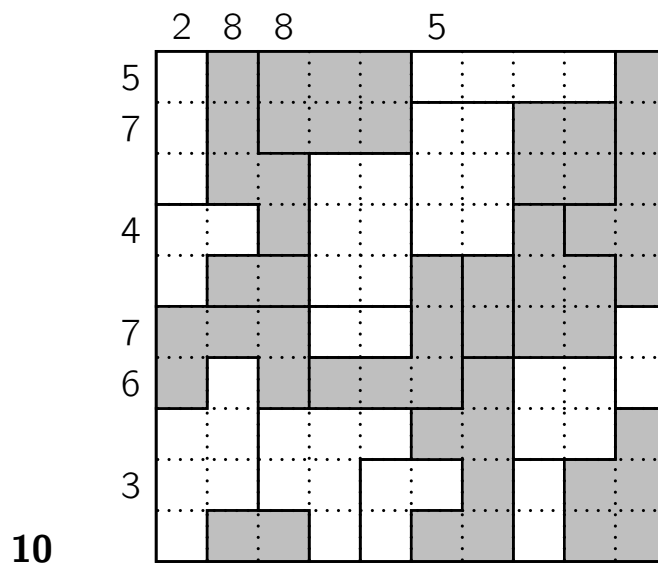
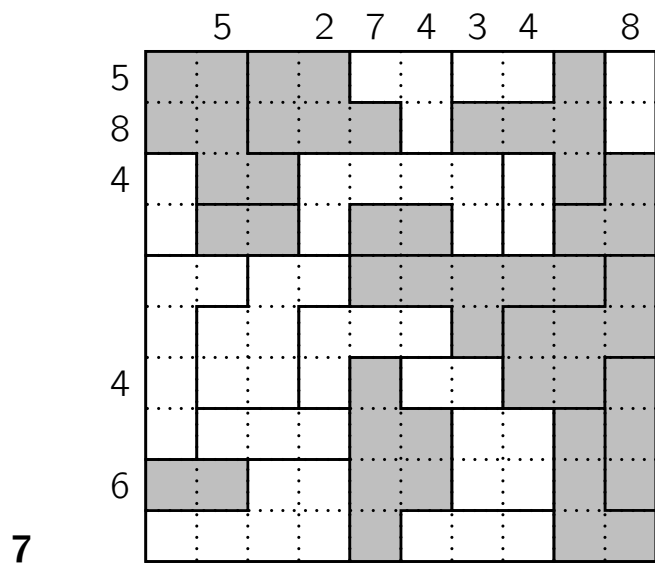

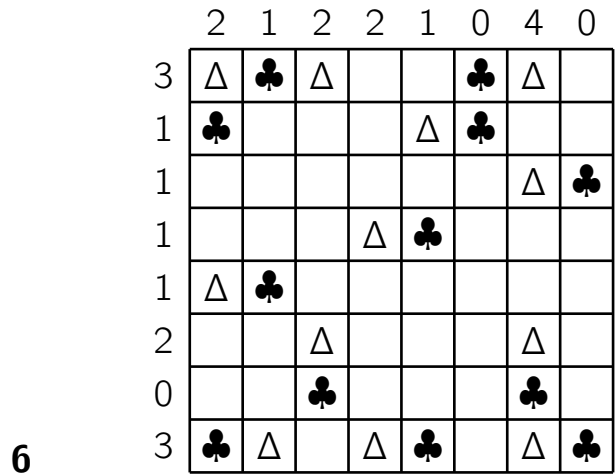
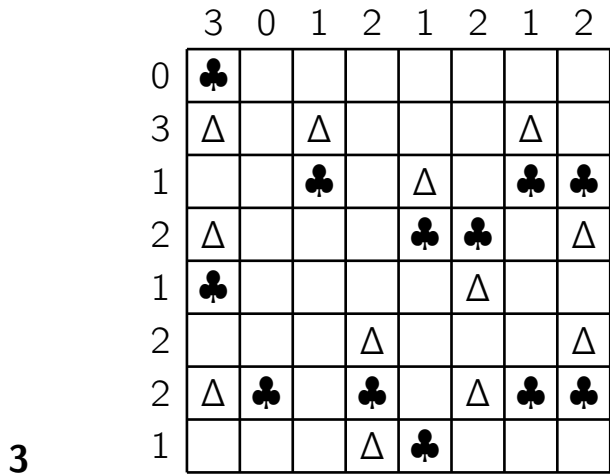
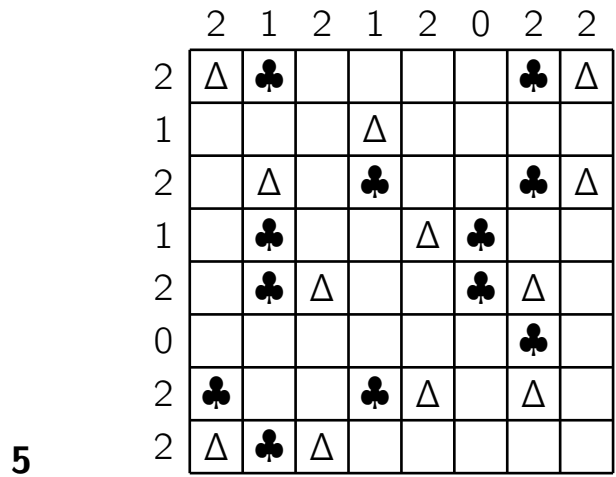
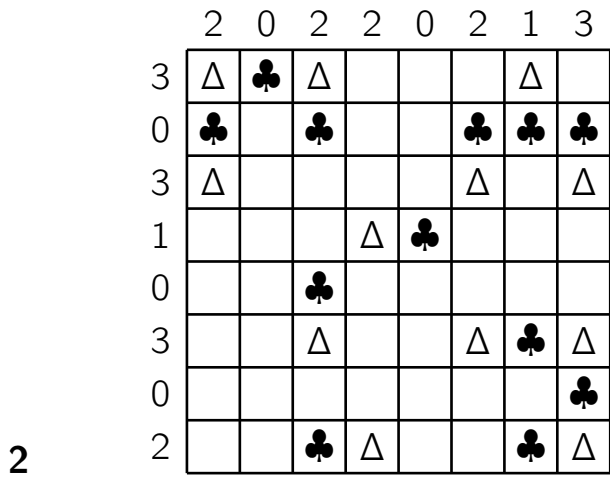
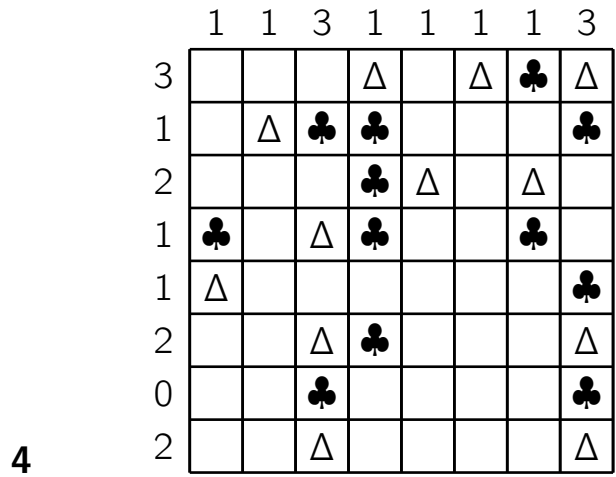
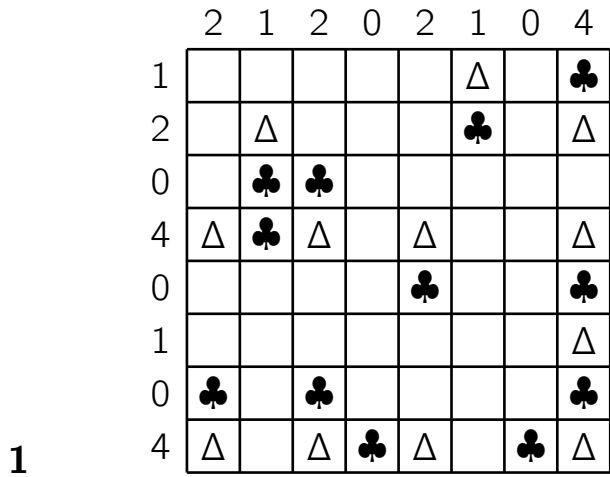



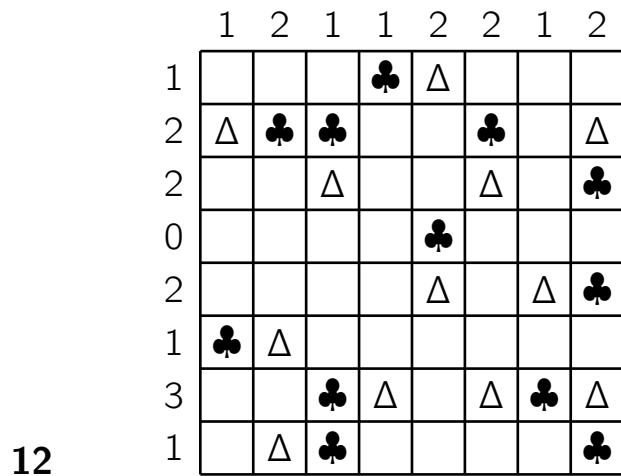
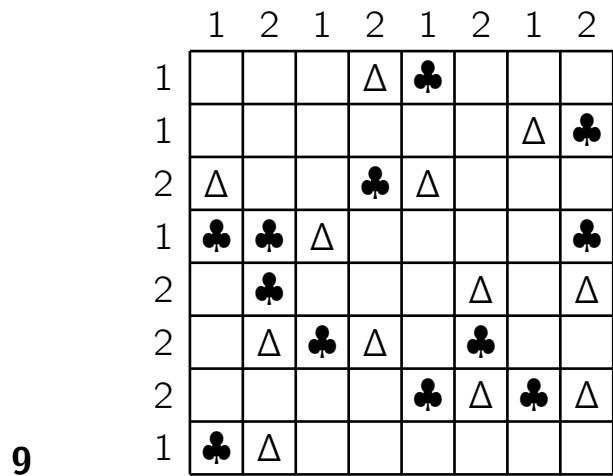
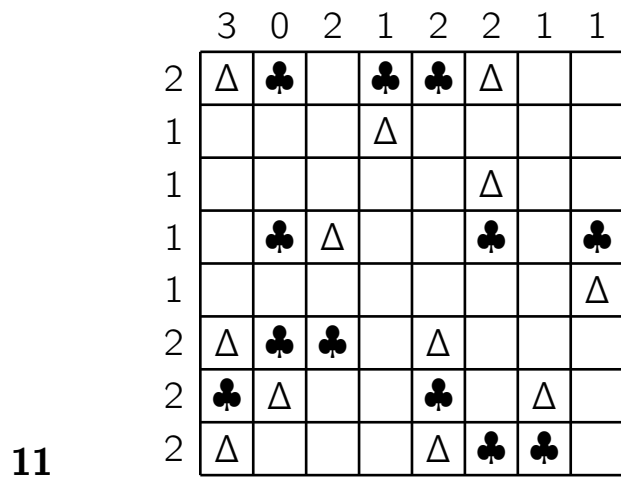
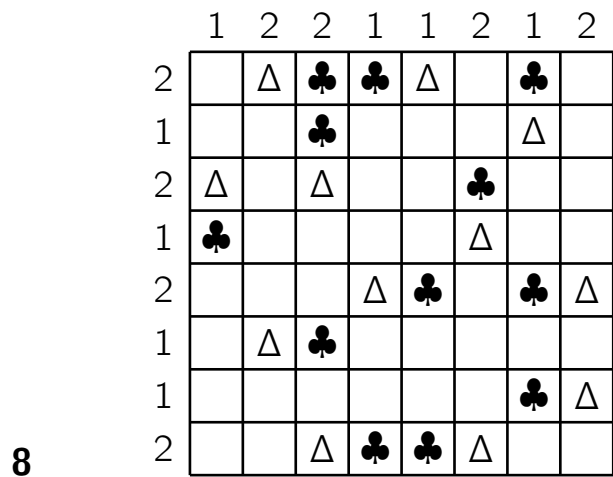
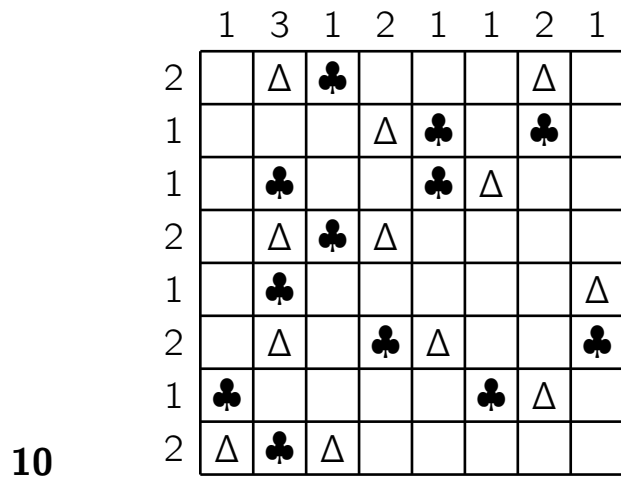
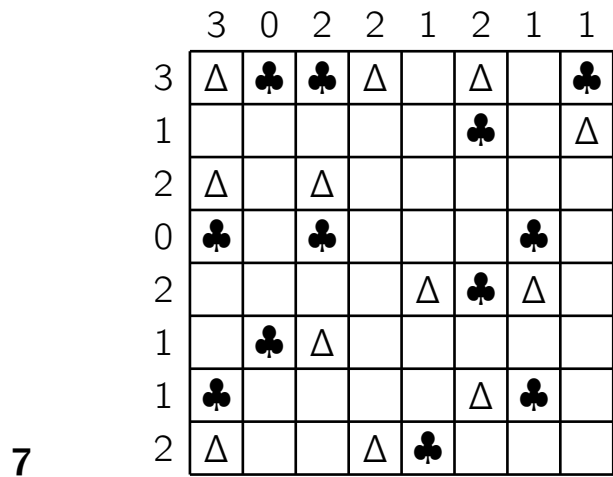

1

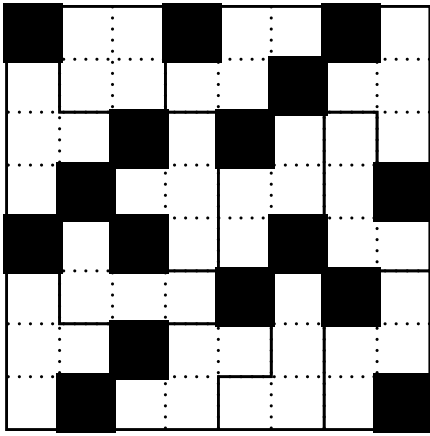

4

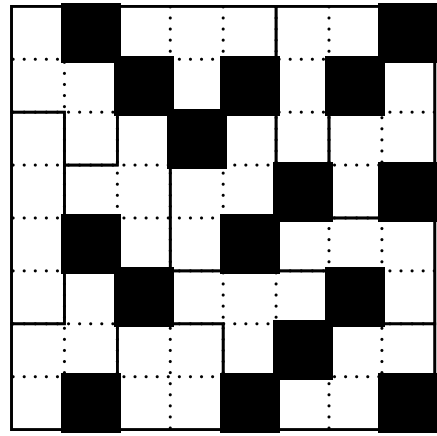

2

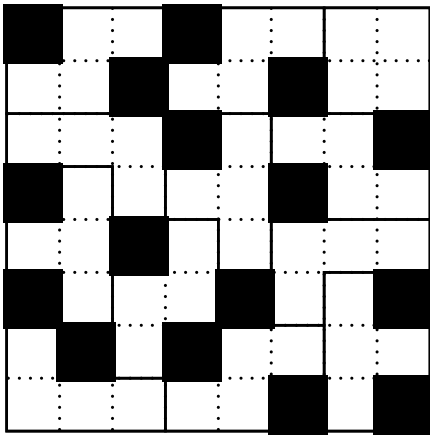

5

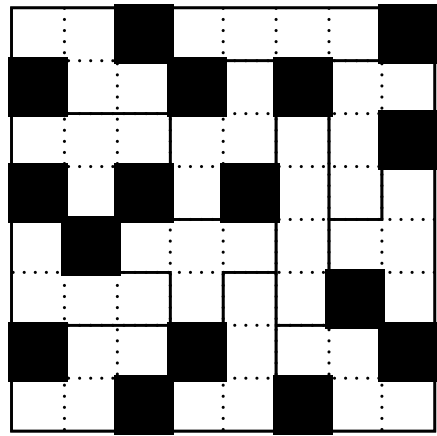

3

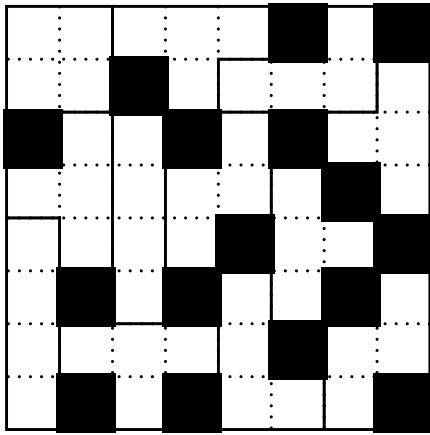

6

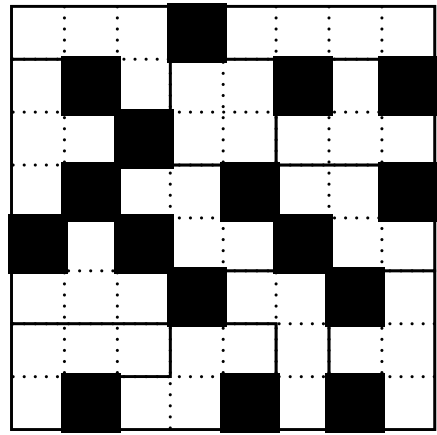

7

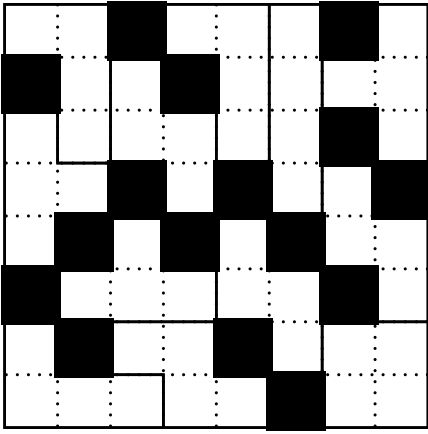

10

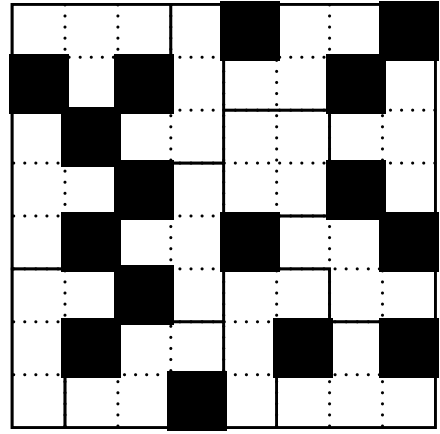

8

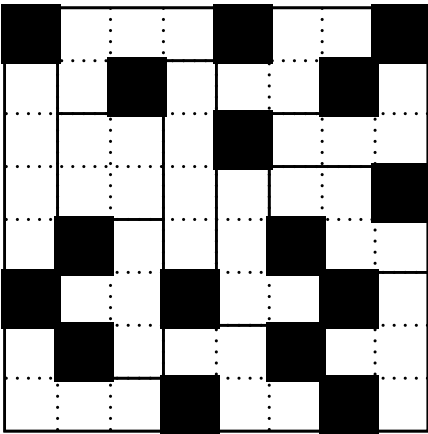

11

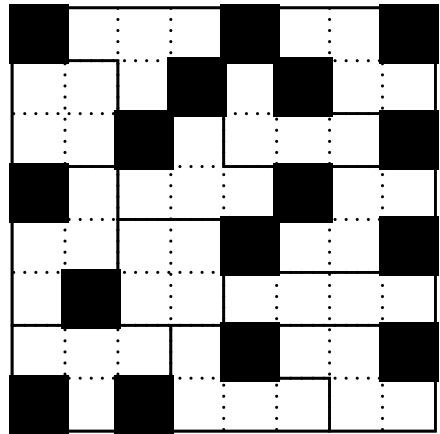

9

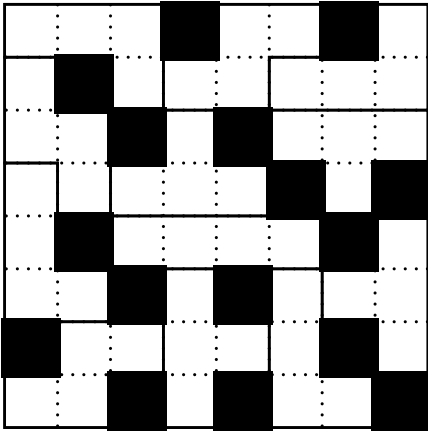

12

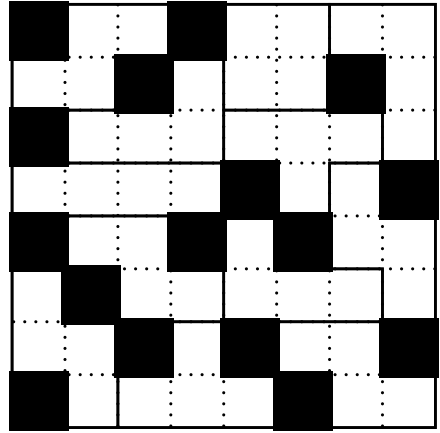

1

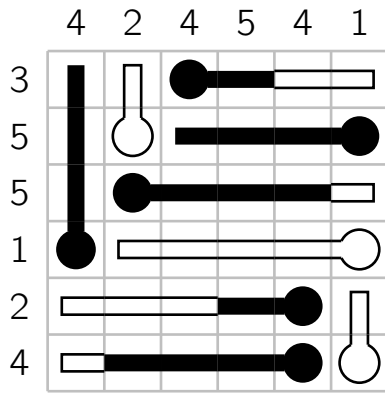

5

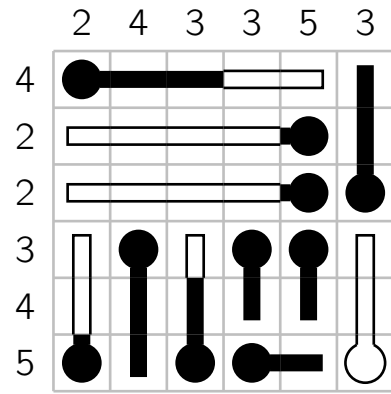

2

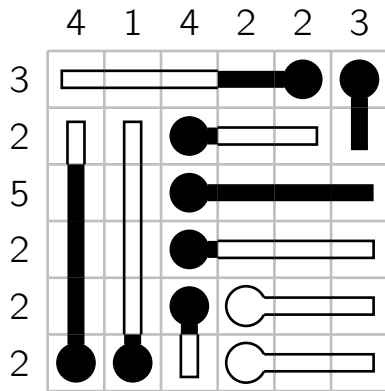

6

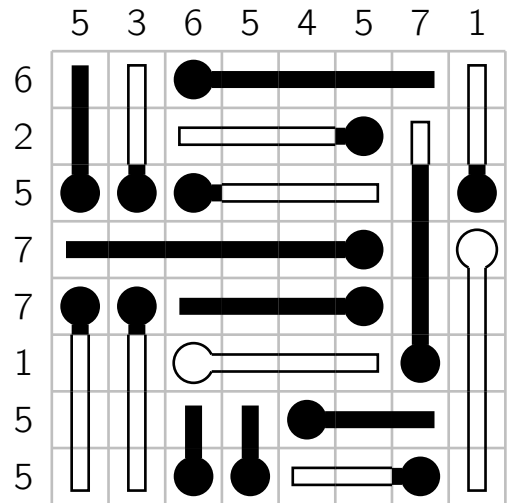

3

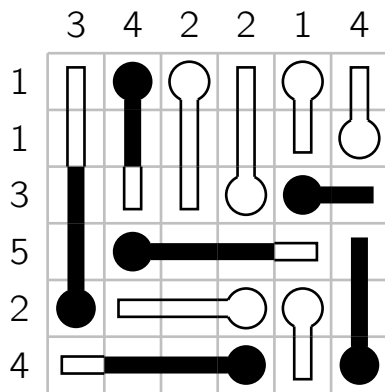

7

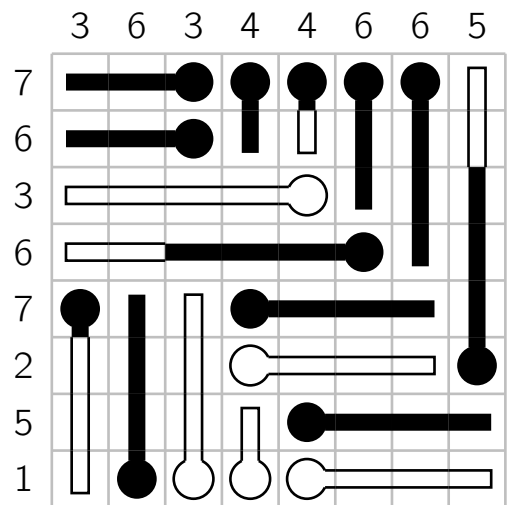

4

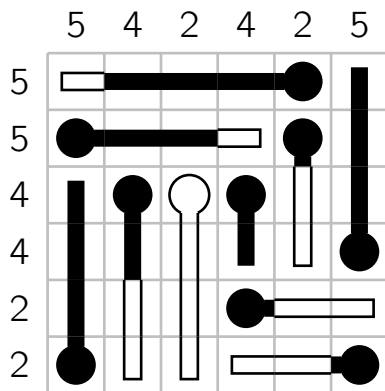

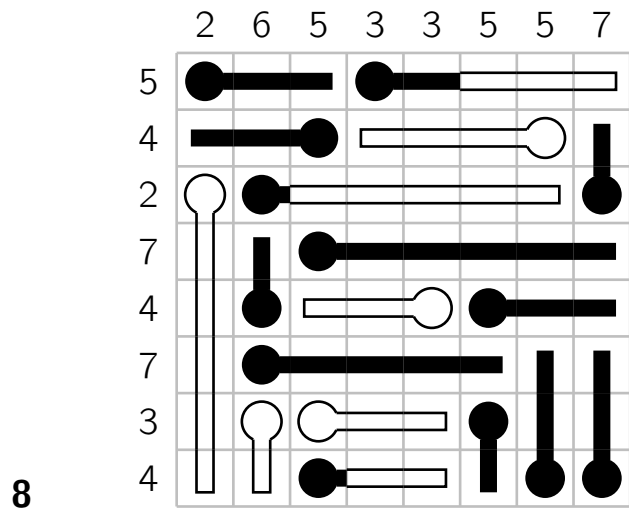

8

11

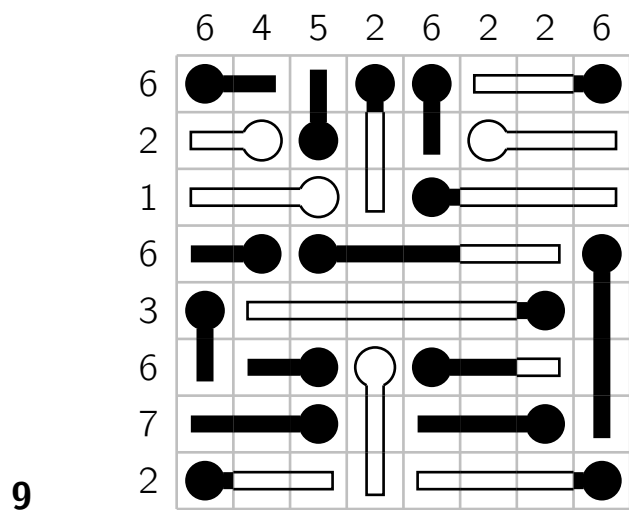
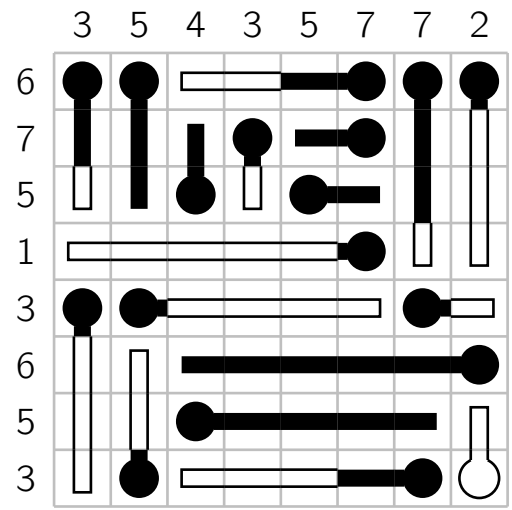

9

12

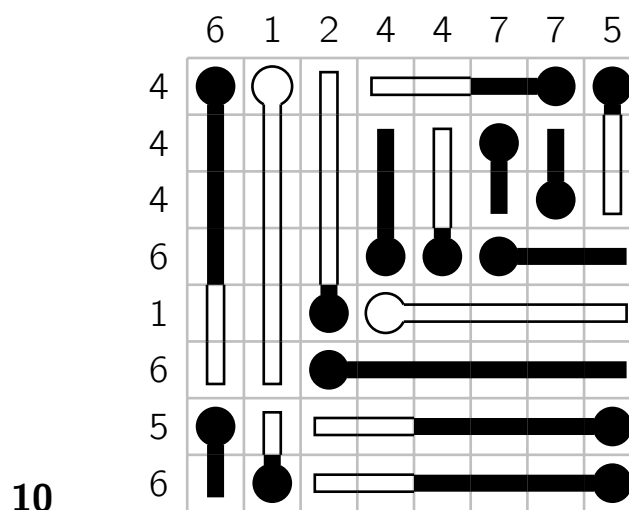
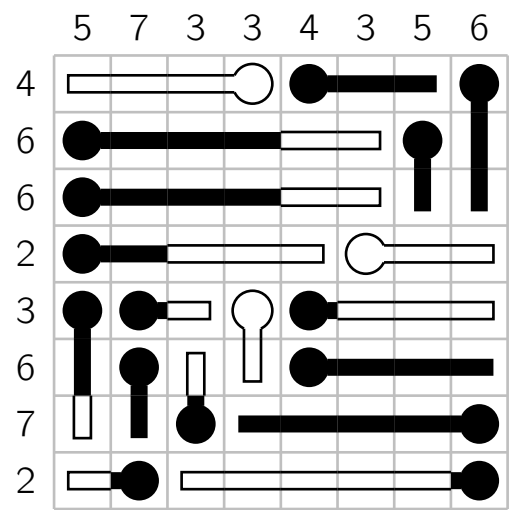

10

13

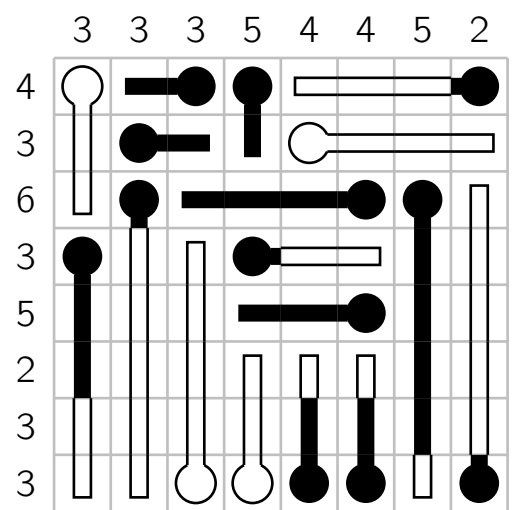

1

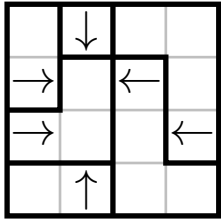

2

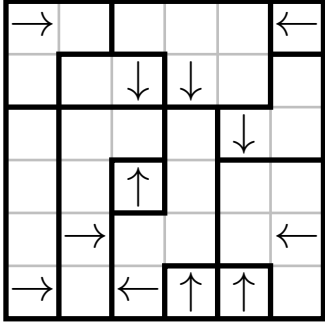

3

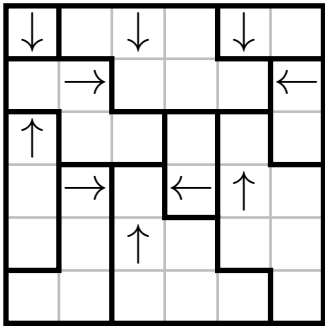

4

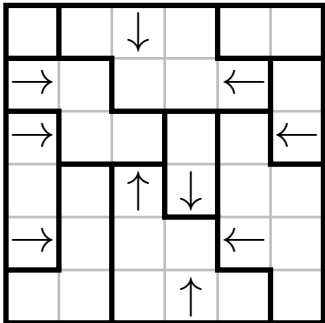

5

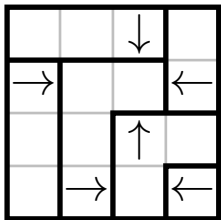

6

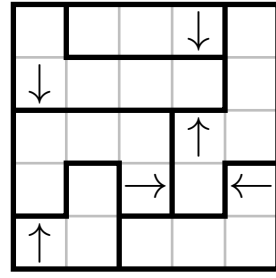

7

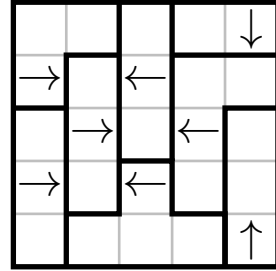

8

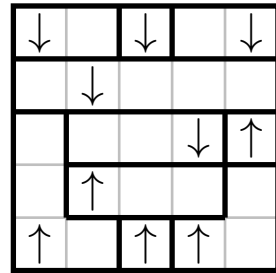

9

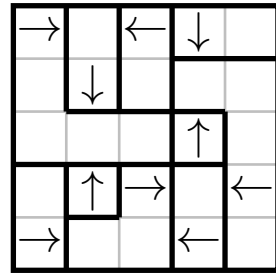

10

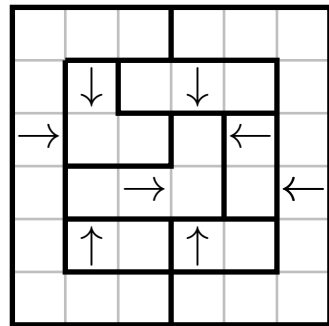

11

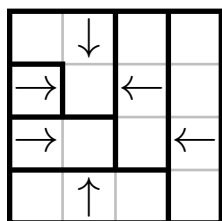

12

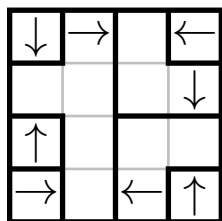

13

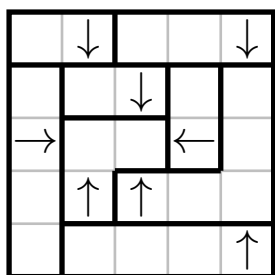

14

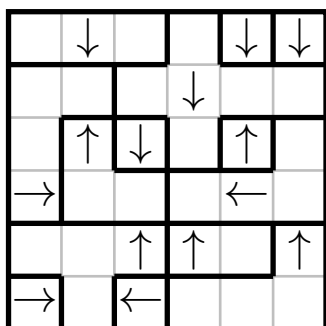

15

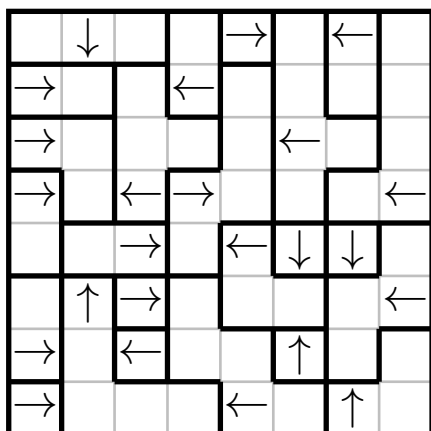

16

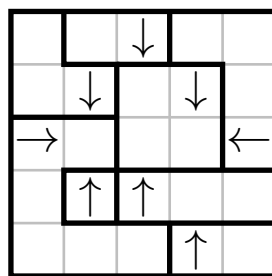

17

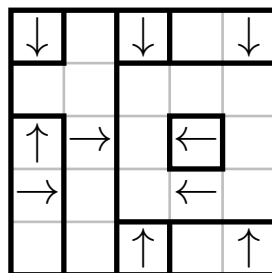

18

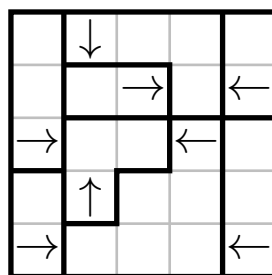

19

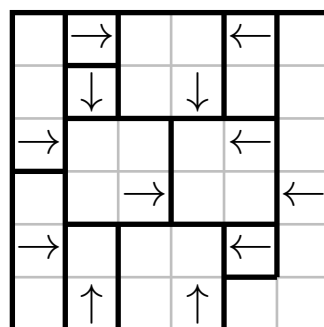

20

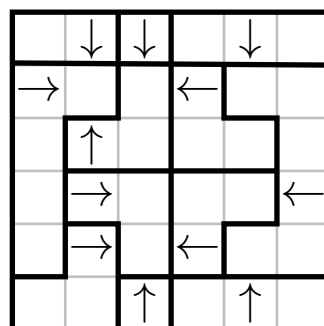

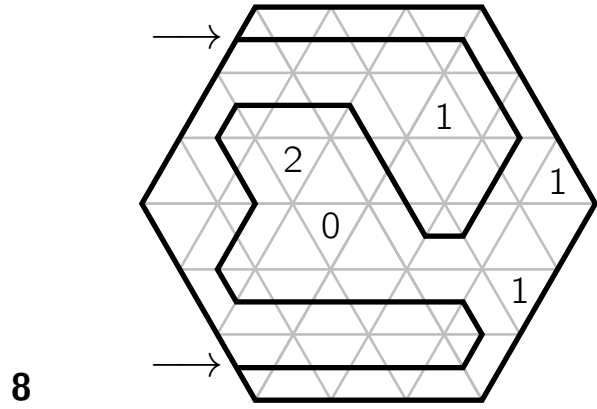
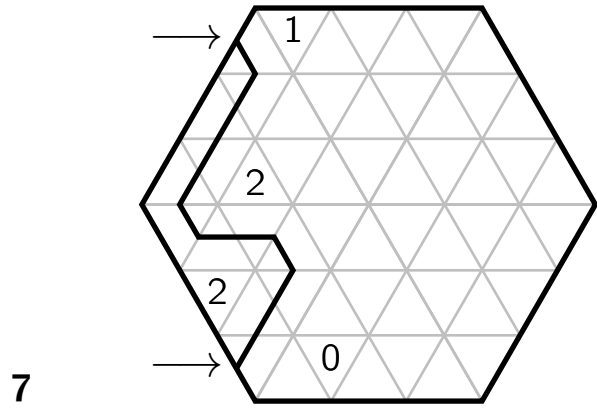
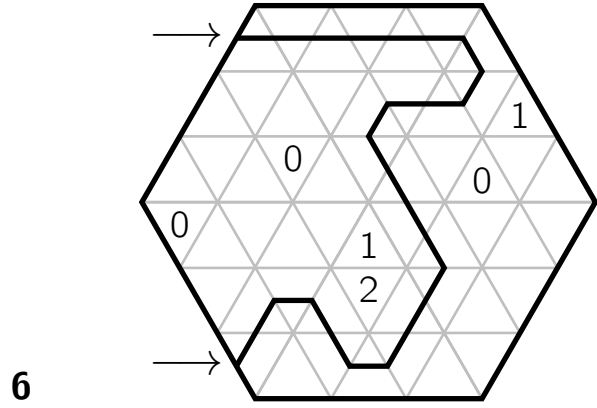
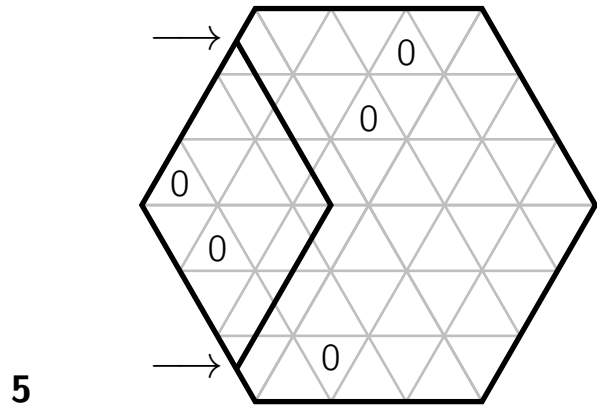
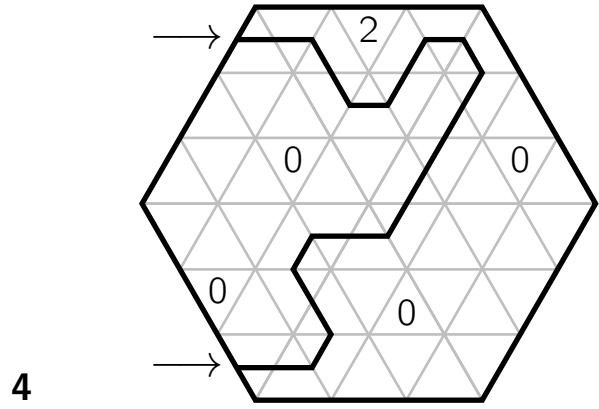
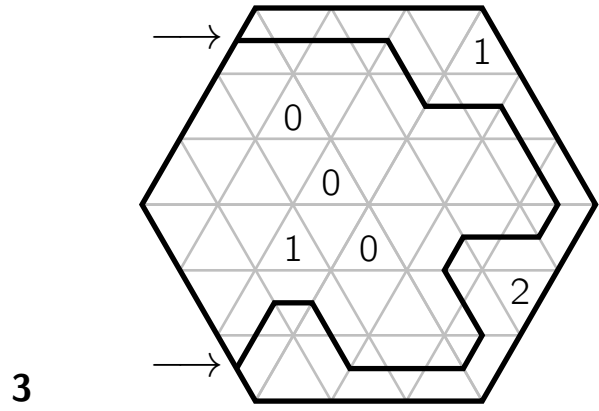
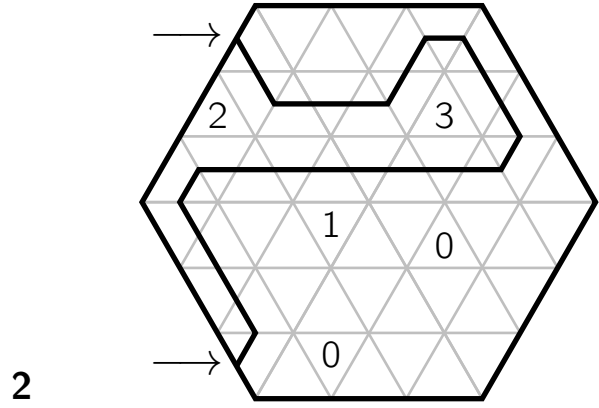
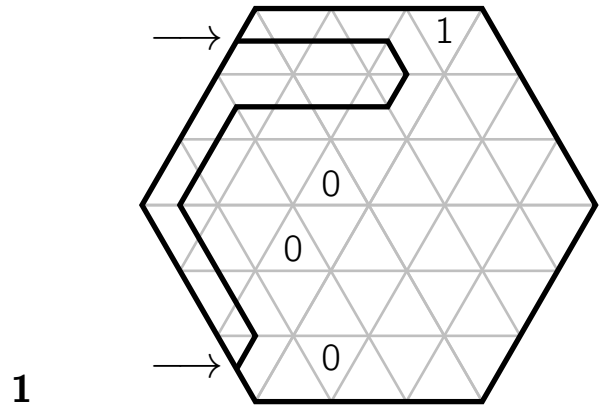





1

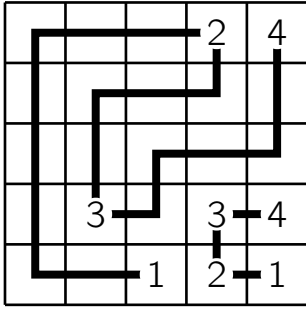

6

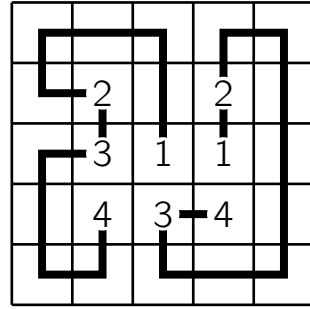

2

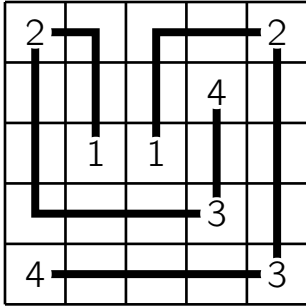

7

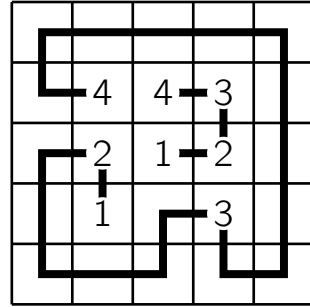

3

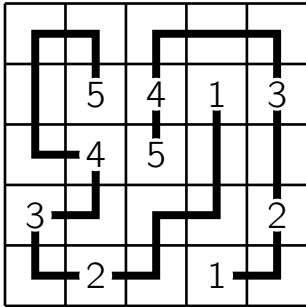

8

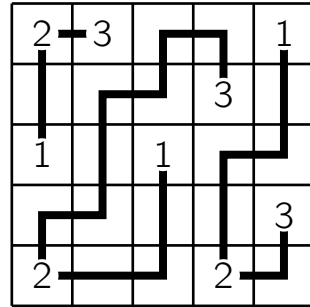

4

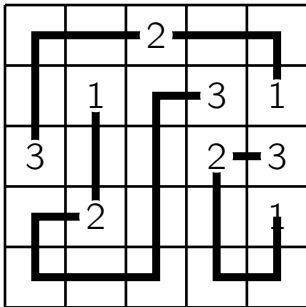

9

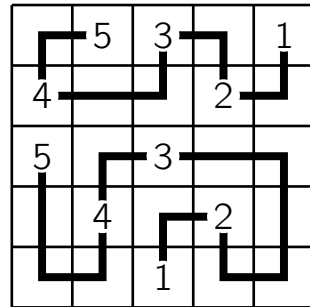

5

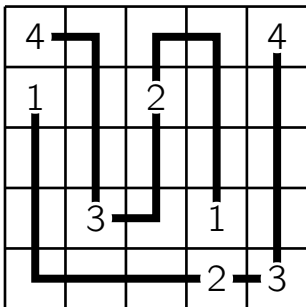

10

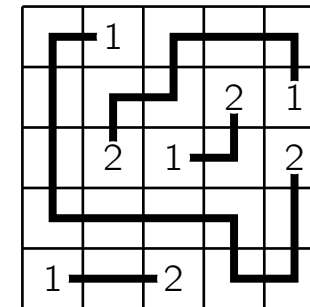



1

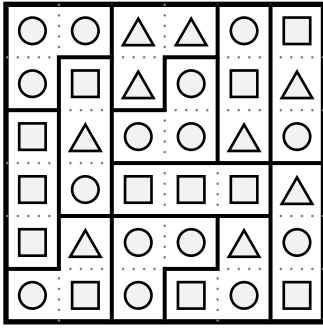

5

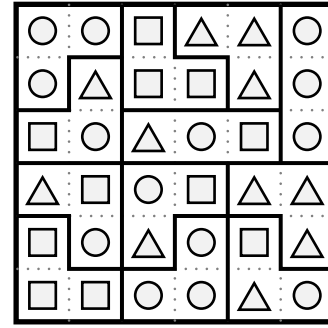

2

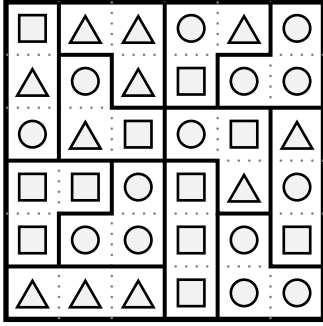

6

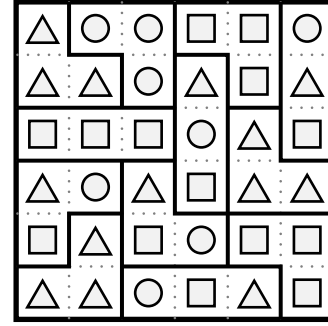

3

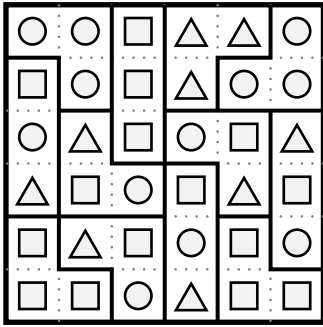

7

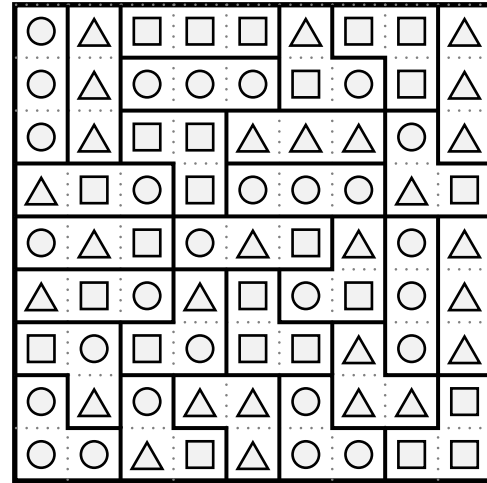

4

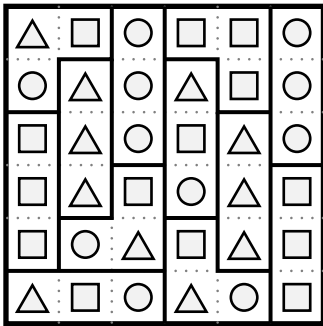

8

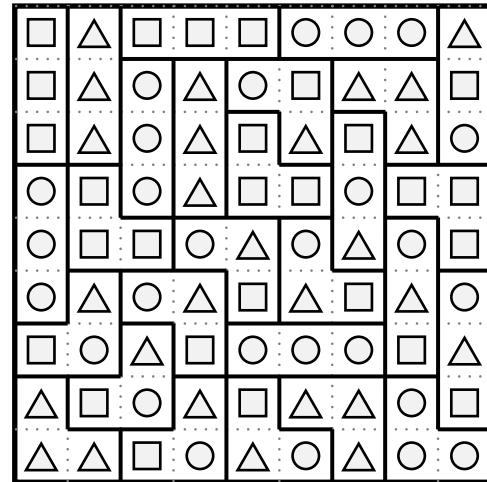

9

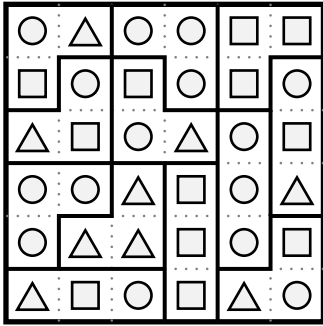

10

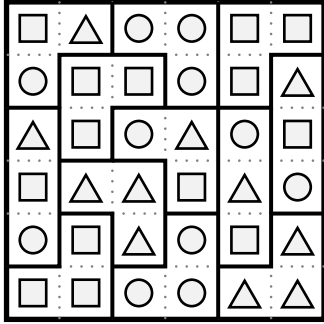

11

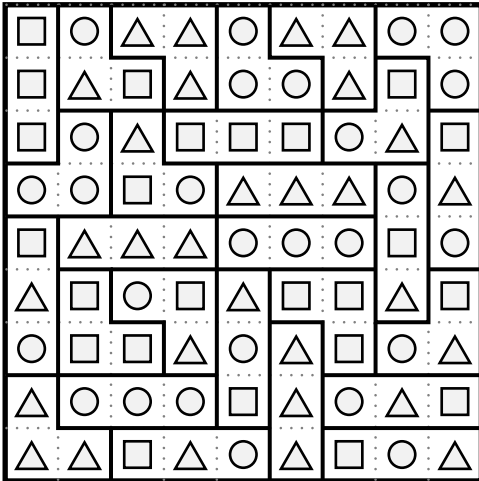

12

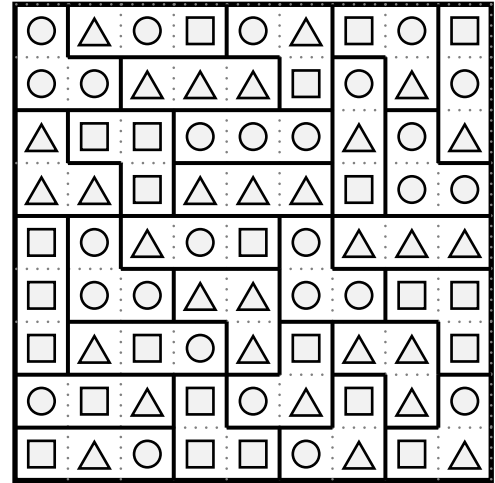

13

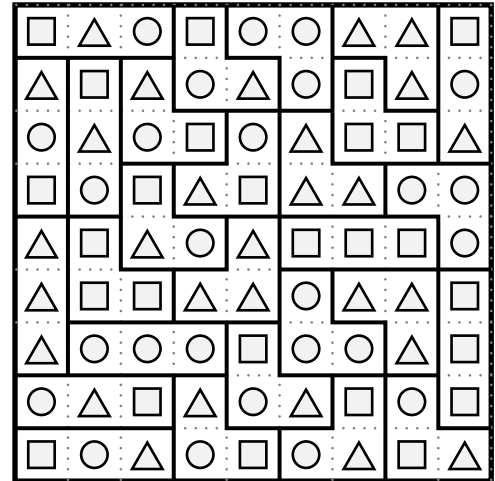

14

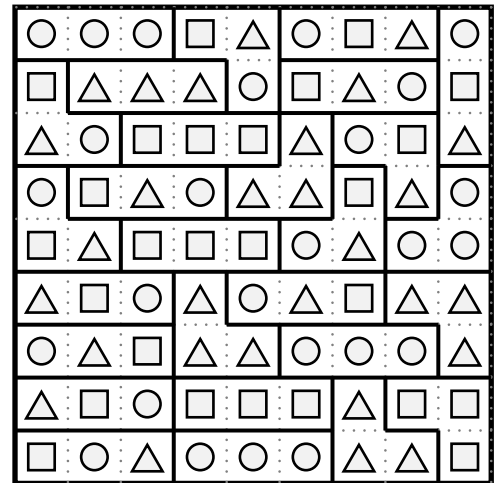

1

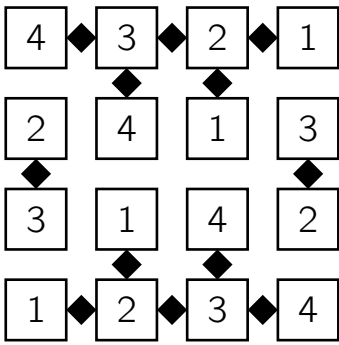

6

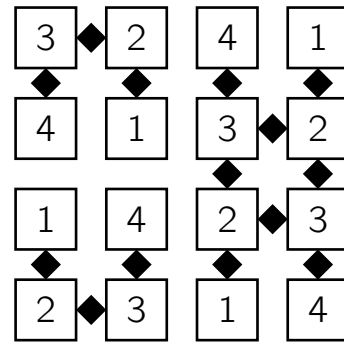

2

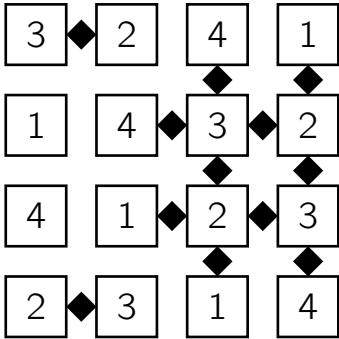

7

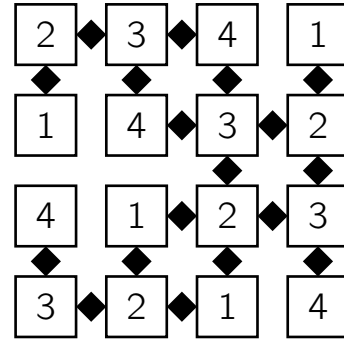

3

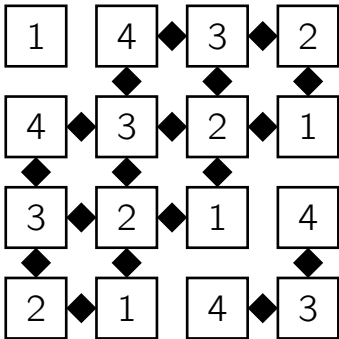

8

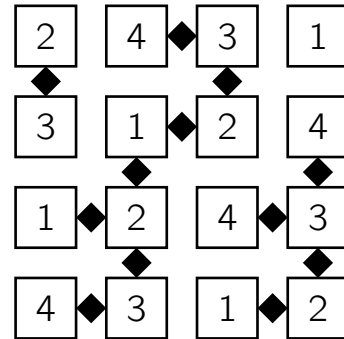

4

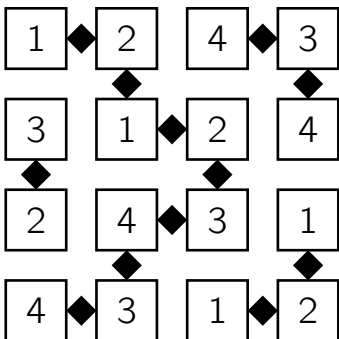

9

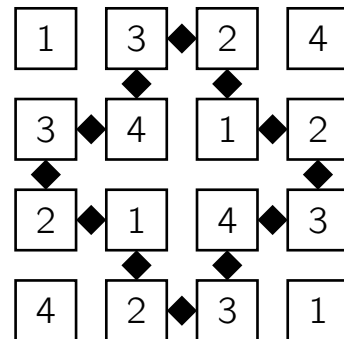

5

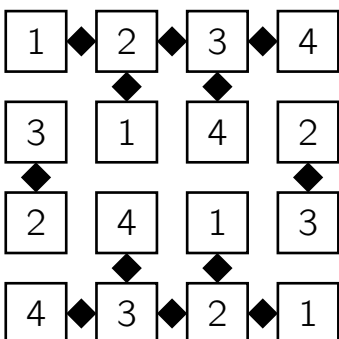

10

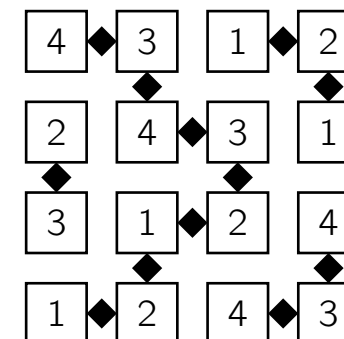

11

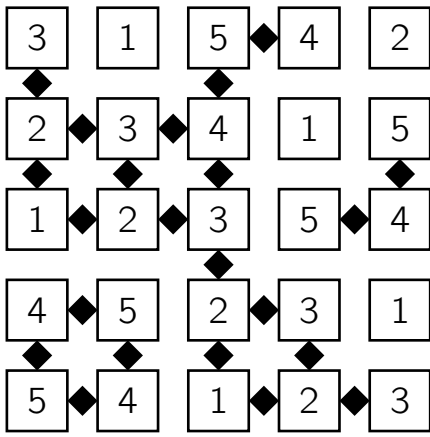

15

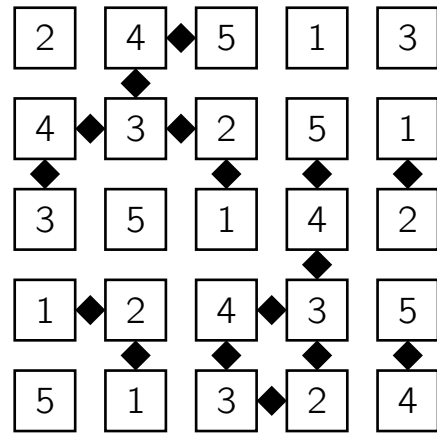

12

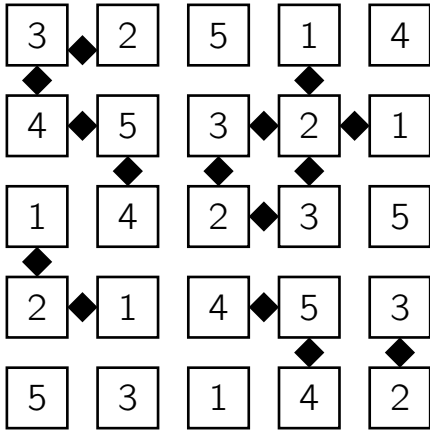

16

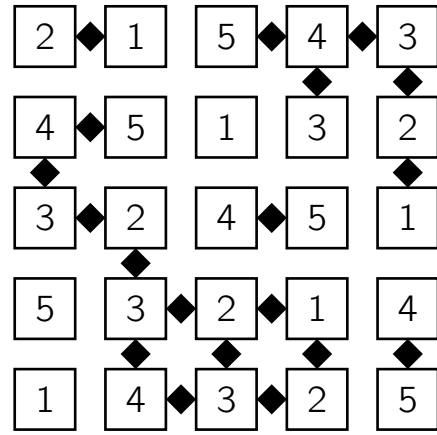

13

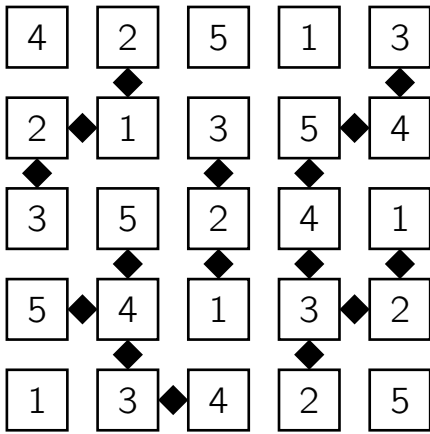

14

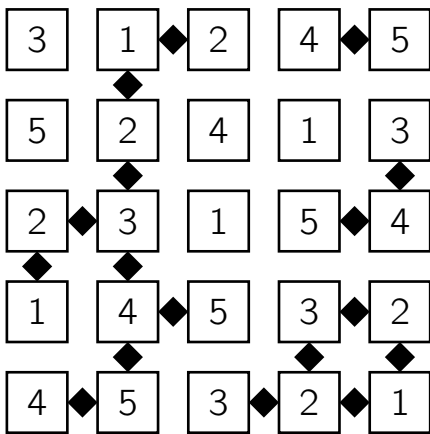

1

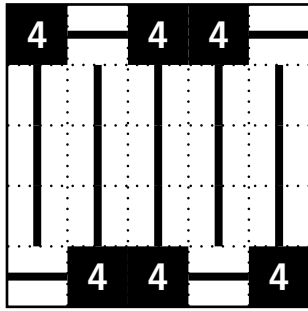

2

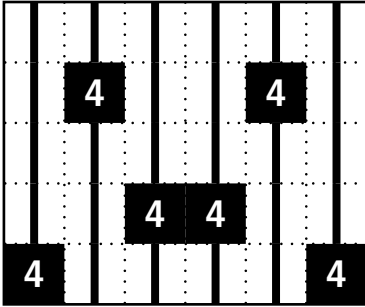

3

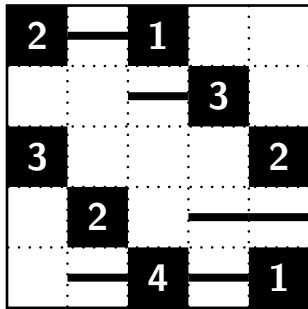

4

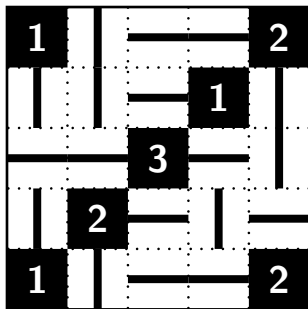

5

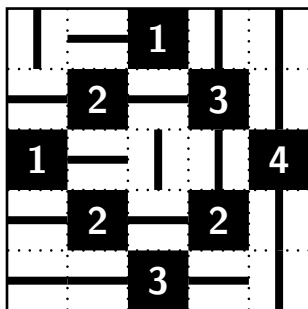

6

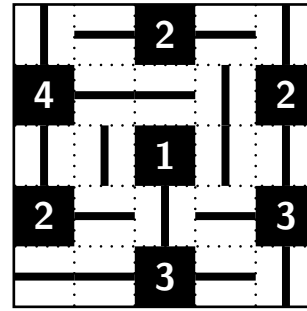

7

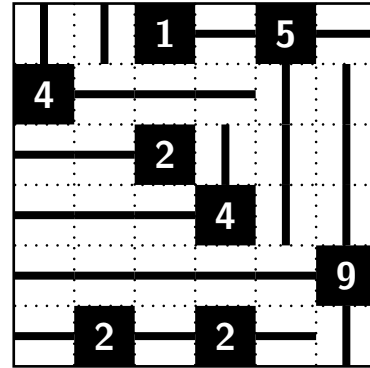

8

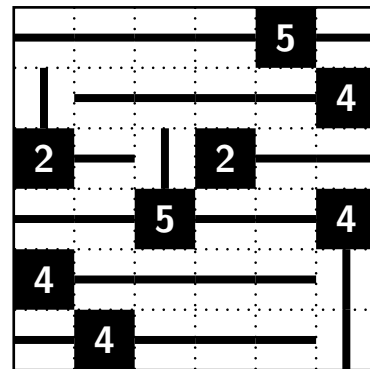

9

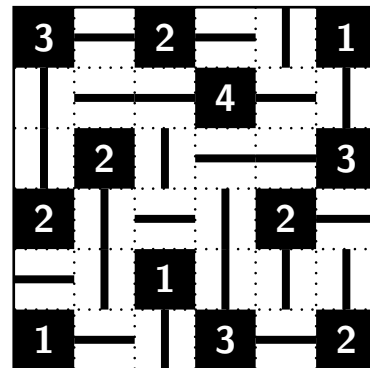

10

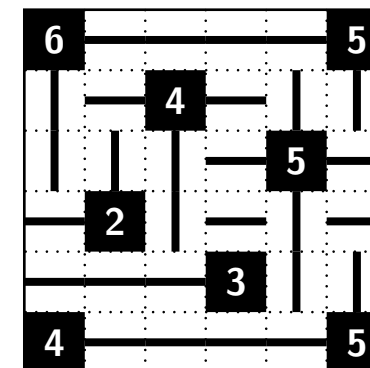



11

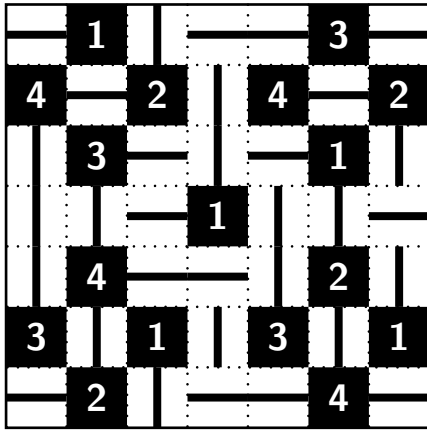

15

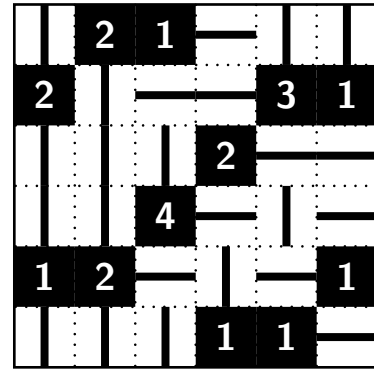

12

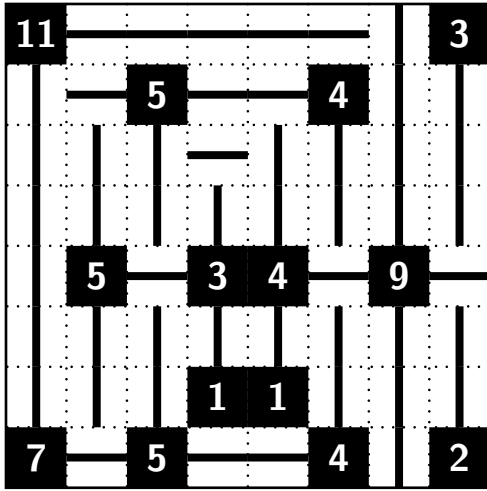

16

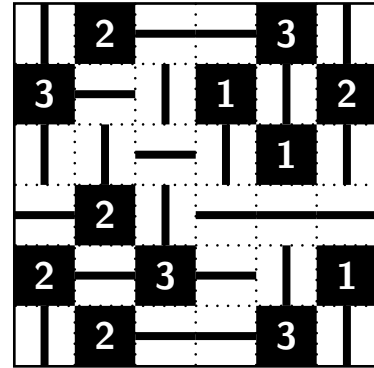

13

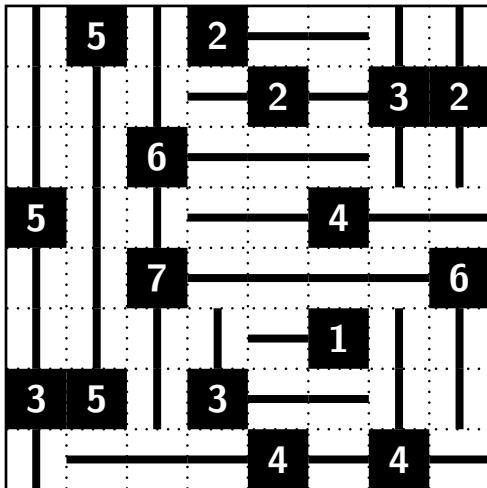

17

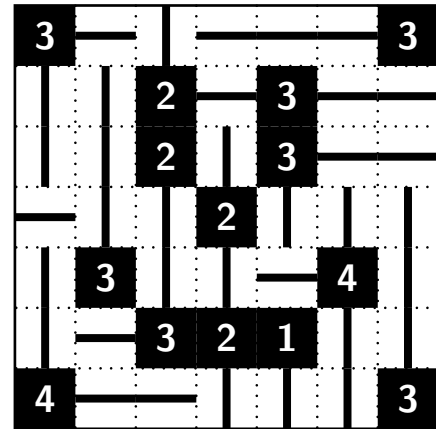

14

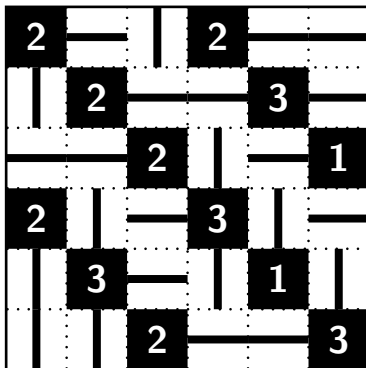

1

1	0	0	0
0	3	3	3
2	0	0	2

3 5

2

3	3	0	3
2	0	0	2
0	0	0	1

5 6

3

0	2	0	2	0
0	0	1	0	0
4	4	0	4	4
3	3	0	3	0

1

4

0	0	1	0	0
2	0	2	0	0
4	4	0	4	4
0	3	3	3	0

6 6

5

3	3	3	0	0
0	4	4	4	4
2	0	0	0	2
0	1	0	0	0

5 8 4 6

6

0	3	0	3	3
0	2	0	2	0
0	0	0	1	0
4	4	4	4	0

4 9 10 3

7

0	0	0	1	0	0
3	3	0	0	3	0
4	0	4	4	0	4
0	0	0	2	2	0
5	5	0	5	5	5

4 12 10 9

8

5	5	0	5	5	5
0	2	2	0	0	0
3	0	0	3	3	0
0	0	0	0	1	0
4	4	0	0	4	4

11 2 13 9

9

0	1	0	0	0	0
5	5	5	5	5	0
4	4	0	4	0	4
0	0	2	2	0	0
3	0	3	0	0	3

12 10 11 7

10

0	0	0	1	0	0
3	3	0	0	3	0
4	0	4	4	0	4
0	0	0	2	2	0
5	5	0	5	5	5

4 12 10 9

11

1	0	0	0	0	0
0	2	2	0	0	0
0	0	3	3	3	0
0	0	4	4	4	4
5	5	5	5	5	0

6 7 14 12

0	3	0	0	3	3
4	0	4	4	4	0
0	2	0	0	0	2
5	5	5	0	5	5
0	0	0	1	0	0

12

9 10 5 10

4	0	4	4	0	4
0	3	3	0	3	0
0	0	0	2	2	0
0	0	0	0	0	1
5	5	5	5	0	5

17

9 8 12 5 10

5	0	5	5	5	5
0	0	2	0	0	2
0	0	0	0	0	1
3	3	0	0	0	3
0	4	0	4	4	4

13

8 7 9 15

1	0	0	0	0	0
0	4	4	4	4	0
0	5	5	5	5	5
0	2	2	0	0	0
0	3	0	3	0	3

18

14 11 12 9 8

0	3	3	3	0	0
5	5	5	0	5	5
0	1	0	0	0	0
2	0	0	0	0	2
4	4	0	4	4	0

14

11 13 7 9 7

5	5	5	5	0	5
4	4	0	4	4	0
3	3	0	0	3	0
2	0	0	0	0	2
0	1	0	0	0	0

15

14 13 5 9 7

1	0	0	0	0	0
0	2	0	2	0	0
3	0	3	0	3	0
0	4	0	4	4	4
5	0	5	5	5	5

16

9 6 8 11 9

**1**

4	3	5	7	8	2	6	9	1	0
0	9	8	1	5	7	3	4	2	6
8	1	0	9	2	6	5	7	3	4
9	4	8	5	3	1	2	6	0	7
0	2	9	7	4	8	3	1	5	6
21	19	30	29	22	24	19	27	11	23

**5**

2	7	0	4	1	6	5	9	8	3
8	5	2	9	7	4	3	6	1	0
4	7	1	5	6	8	0	2	9	3
9	2	4	7	0	1	3	8	5	6
6	8	1	9	4	5	0	7	2	3
29	29	8	34	18	24	11	32	25	15

**2**

4	2	8	0	5	9	3	1	7	6
5	1	6	4	2	7	8	0	3	9
7	8	0	9	6	3	1	4	2	5
9	6	7	3	0	2	5	8	1	4
8	1	9	6	4	3	0	2	5	7
33	18	30	22	17	24	17	15	18	31

**6**

2	0	5	9	6	8	1	3	7	4
1	9	8	7	5	4	2	0	6	3
4	6	2	9	3	7	8	1	5	0
5	0	4	6	2	9	3	7	8	1
3	8	5	1	0	7	2	9	6	4
15	23	24	32	16	35	16	20	32	12

**3**

9	1	5	0	7	6	4	3	2	8
6	0	9	1	5	2	7	8	4	3
3	2	8	7	0	4	6	9	5	1
5	1	0	2	3	7	8	4	6	9
2	4	5	6	9	1	3	7	8	0
25	8	27	16	24	20	28	31	25	21

**7**

7	5	1	8	3	6	0	4	9	2
4	0	2	5	1	9	7	3	8	6
5	8	4	3	8	6	1	0	7	2
6	2	0	1	7	3	5	9	4	8
4	5	3	2	6	1	8	0	7	9
26	21	10	19	25	25	21	16	35	27

**4**

0	8	1	5	4	3	6	7	9	2
3	7	0	9	1	8	4	2	6	5
9	1	8	7	4	6	0	5	3	2
4	0	3	1	2	8	9	6	7	5
9	6	4	0	3	1	7	5	8	2
25	22	16	22	14	26	26	25	33	16

**8**

7	0	3	9	2	8	6	5	4	1
4	2	5	0	6	7	1	9	3	8
0	7	3	8	5	9	6	2	1	4
3	6	0	1	7	8	4	9	5	2
1	4	8	5	3	0	7	2	6	9
15	19	19	23	23	32	24	27	19	24

**9**

1	4	0	2	6	9	3	8	7	5
5	2	1	7	0	8	6	9	3	4
4	8	5	2	3	7	0	1	6	9
2	6	4	8	5	9	3	7	0	1
0	3	2	1	4	7	5	9	8	6
12	23	12	20	18	40	17	34	24	25

**13**

5	2	8	9	1	4	6	3	7	0
1	7	3	0	8	9	2	4	6	5
8	0	5	7	3	1	6	9	2	4
5	9	2	6	0	8	3	4	1	7
8	1	5	3	2	6	0	7	9	4
27	19	23	25	14	28	17	27	25	20

**10**

6	1	7	2	5	4	0	9	3	8
7	3	6	9	8	2	5	4	0	1
2	5	0	3	1	4	8	7	9	6
3	9	6	5	2	7	1	4	8	0
5	7	0	9	8	3	2	6	1	4
23	25	19	28	24	20	16	30	21	19

**14**

6	5	8	7	2	3	4	0	1	9
1	7	3	5	6	9	8	2	4	0
6	0	2	4	7	3	1	9	8	5
8	5	3	0	2	9	7	6	1	4
2	1	7	5	6	0	8	4	9	3
23	18	23	21	23	24	28	21	23	21

**11**

2	8	0	3	4	6	7	5	9	1
9	3	2	1	7	5	0	8	6	4
0	7	5	6	3	4	1	2	9	8
9	1	2	8	5	0	3	7	6	4
7	5	9	6	2	4	8	0	3	1
27	24	18	24	21	19	19	22	33	18

**15**

6	1	2	8	7	3	9	5	0	4
0	8	9	1	4	2	7	3	6	5
4	1	0	5	8	6	9	2	7	3
2	8	6	3	4	7	0	5	9	1
6	0	7	8	2	9	4	1	3	5
18	18	24	25	25	27	29	16	25	18

**12**

5	8	4	2	9	0	1	6	7	3
3	9	6	5	7	2	8	0	1	4
6	5	0	9	3	1	4	2	8	7
4	8	7	5	2	9	3	6	0	1
3	9	4	0	6	5	2	1	7	8
21	39	21	21	27	17	18	15	23	23

**16**

5	7	6	4	1	2	8	0	3	9
4	3	1	8	9	7	5	2	6	0
2	6	4	0	3	8	9	7	5	1
4	0	2	7	1	6	5	8	9	3
7	1	8	0	2	3	9	6	4	5
22	17	21	19	16	26	36	23	27	18

1	5	3
1	2	4
6	5	9

1

1	1	4
5	6	3
5	2	6

2

6	12	5
11	1	2
4	3	5

3

4	3	6
5	1	2
0	6	5

4

6	2	5
4	1	3
9	5	6

5

8	8	2	8
3	17	5	6
3	4	1	9
10	7	18	10

6

10	18	12	5
27	8	7	2
9	4	3	6
9	4	4	1

7

6	10	4	4
9	13	3	5
5	1	14	2
10	19	8	7

8

1	5	2	9
8	5	5	3
7	13	4	4
8	6	16	10

9

10

6	12	5	3	5
7	1	10	4	2

11

6	6	11	5
9	1	6	2
8	4	3	7

12

6	5	10	3
1	18	2	9
11	10	9	4
8	8	24	7

13

9	19	2	9
4	8	1	7
3	17	6	13
10	15	5	5

14

7	19	9	5
18	3	4	9
8	1	2	8
8	11	10	6

15

6	1	6	2
5	19	3	8
15	10	9	24
0	14	4	7

16

1	7	2	6
8	4	19	3
15	14	10	18
7	18	9	5

17

3	17	5	7
18	9	6	13
4	1	2	10
14	10	20	8

18

3	<b>17</b>	5	7
<b>16</b>	9	6	<b>13</b>
4	1	2	<b>10</b>
<b>14</b>	10	<b>20</b>	8

19

<b>10</b>	9	6	<b>8</b>
1	4	<b>17</b>	2
7	10	5	8
<b>10</b>	3	<b>8</b>	<b>8</b>

20

10	5	2	9	1
7	<b>26</b>	8	3	4
<b>13</b>	6	<b>18</b>	4	4

21

1	7	2	<b>7</b>
6	8	<b>19</b>	5
3	<b>15</b>	4	<b>9</b>

22

1	<b>5</b>	<b>12</b>	2
8	4	10	<b>12</b>
7	3	<b>22</b>	<b>5</b>
<b>13</b>	6	9	5

23

<b>13</b>	8	7	<b>13</b>
5	<b>26</b>	3	6
<b>17</b>	10	<b>26</b>	9
2	<b>16</b>	4	1

24

<b>13</b>	7	4	3	8
6	1	<b>14</b>	<b>15</b>	2
5	<b>15</b>	9	10	<b>12</b>

25

<b>10</b>	3	9	4
7	<b>21</b>	10	8
<b>13</b>	1	<b>19</b>	2
5	<b>12</b>	6	<b>8</b>

26

6	5	11	16	<b>19</b>
<b>6</b>	<b>14</b>	<b>11</b>	<b>34</b>	3
<b>10</b>	9	<b>26</b>	15	10
1	13	2	<b>29</b>	4
<b>15</b>	14	12	8	7

27

<b>13</b>	12	4	<b>6</b>	<b>6</b>
1	<b>24</b>	<b>9</b>	2	6
8	11	3	7	5
14	<b>50</b>	10	<b>46</b>	13
<b>29</b>	15	9	16	<b>29</b>

1

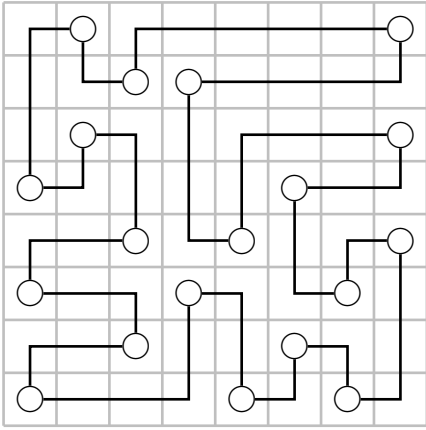

2

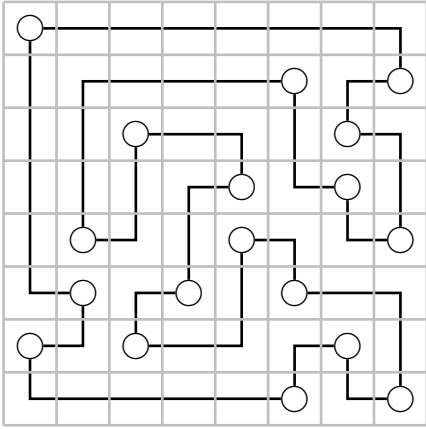

3

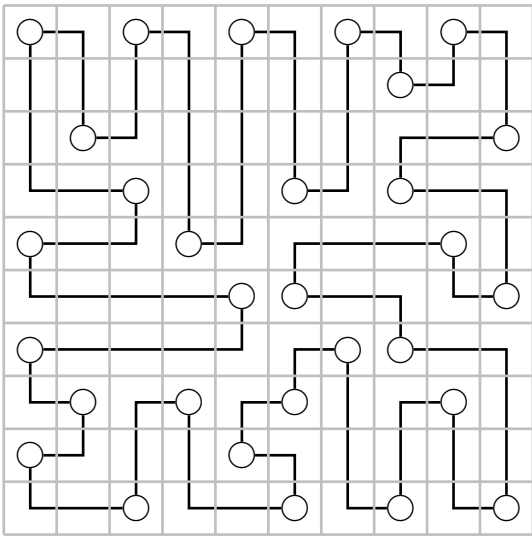

4

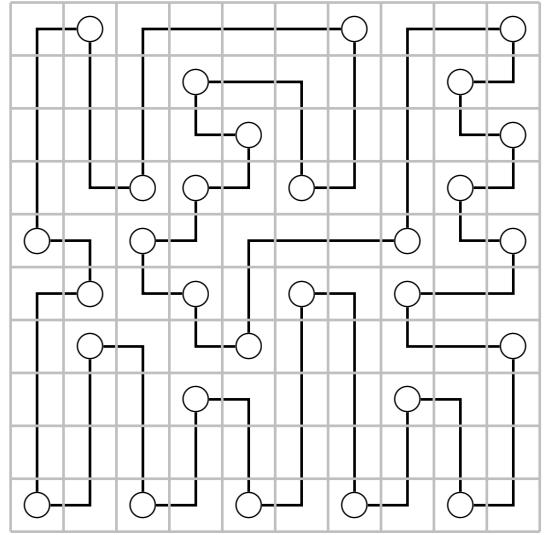

5

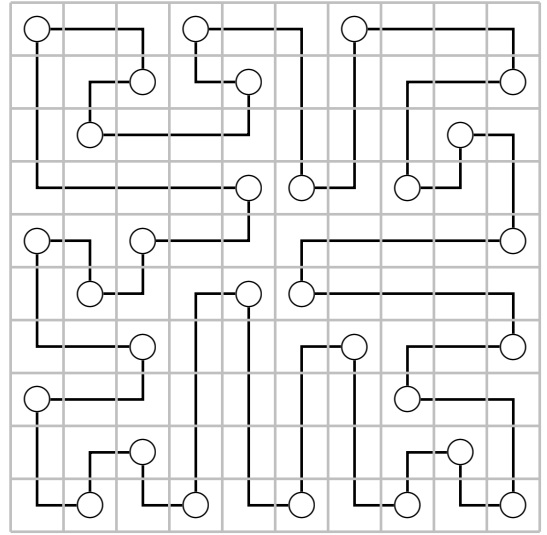

6

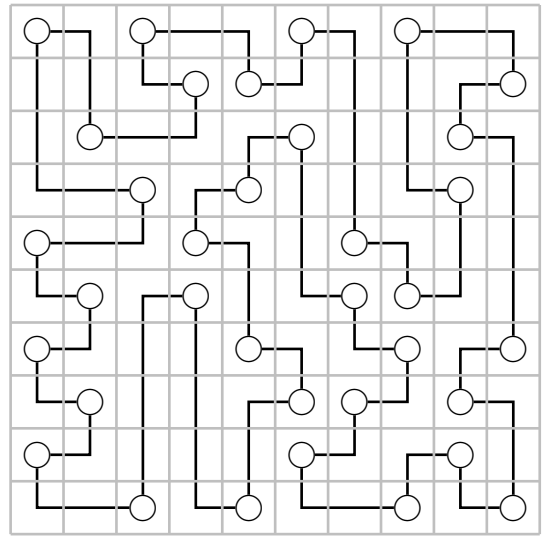



7

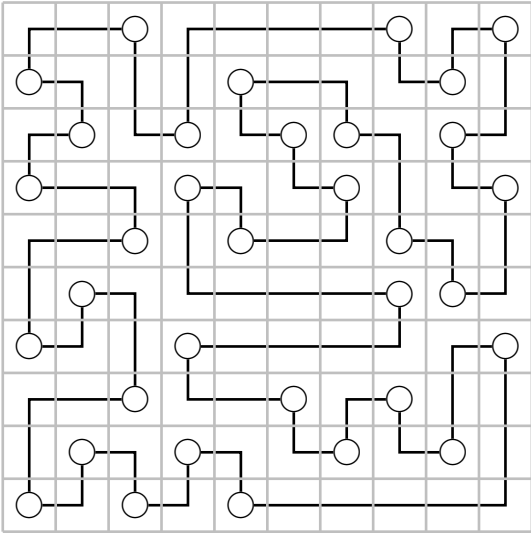

10

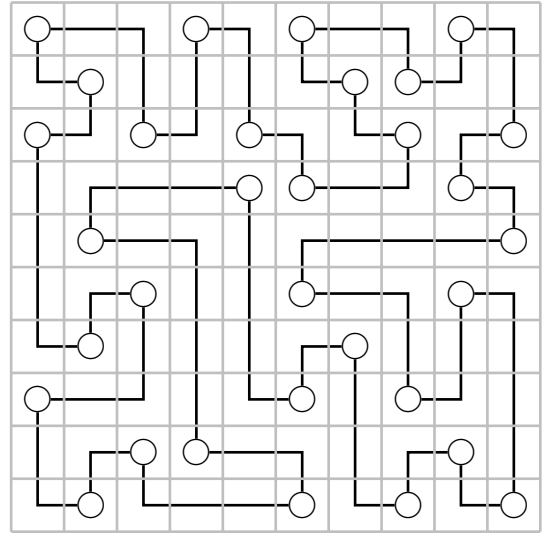

8

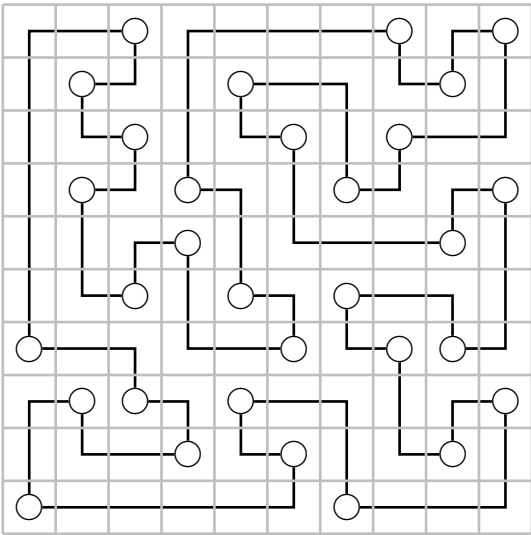

11

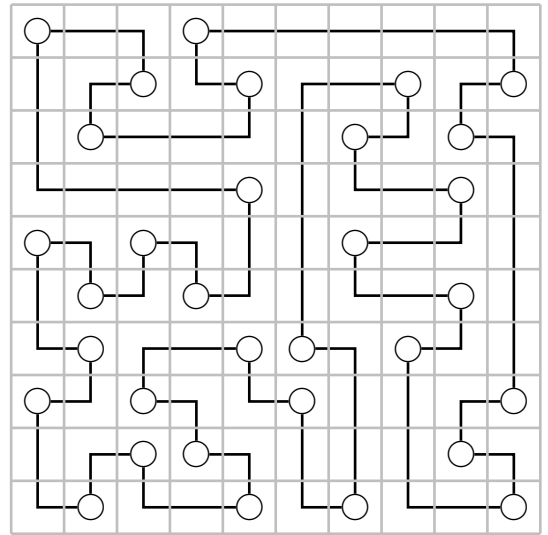

9

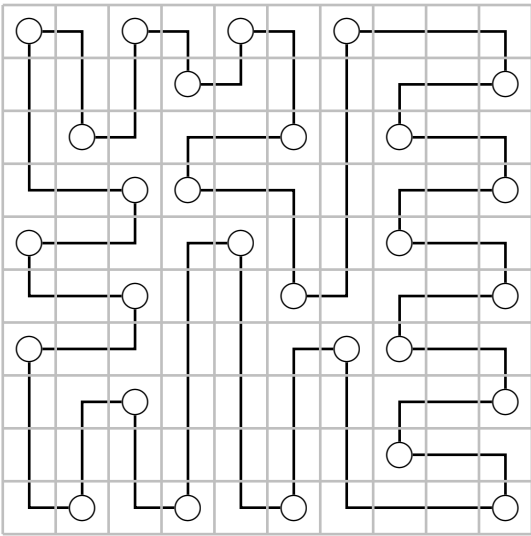

12

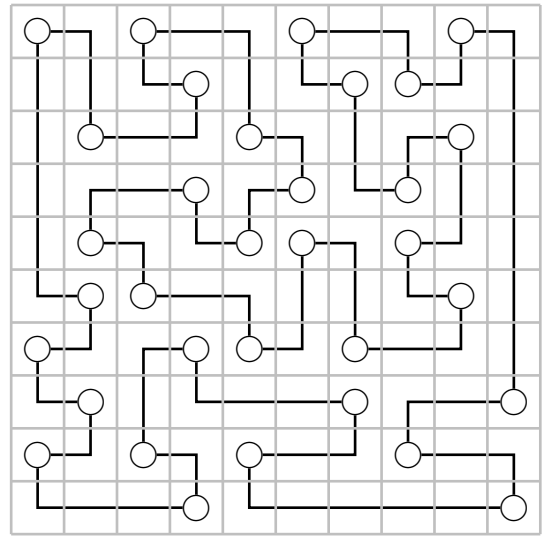

## Des sources et des ressources

Voici quelques ressources (et des liens hypertextes !) où chacun pourra trouver d'autres grilles.

Le site ou le document duquel sont extraites les grilles présentées est écrit en italique.

Chaque ressource est précédée du codage QIS.

- I signifie que le site propose une grille Interactive où l'on peut remplir directement des propositions (l'absence du I implique que le site (le cas échéant) propose une grille en pdf ou comme image) ;
- Q signifie que le site propose une grille Quotidienne ;
- S signifie que le site/document propose la possibilité de voir la Solution, même si la grille n'est pas terminée.

### ABC Kombi

(I S) *<https://www.janko.at/Raetsel/Abc-Kombi/index.htm>*

### ABC Path — Chemin ABC

1. (IQS) *<https://www.brainbashers.com/abcpath.asp>*
2. (I S) *<https://www.janko.at/Raetsel/Abc-Pfad/index.htm>*

### Akari — Light up

1. (IQS) *<https://www.brainbashers.com/lightup.asp>*
2. (I S) *<https://www.janko.at/Raetsel/Akari/index.htm>*
3. (I S) *<http://www.nikoli.com/en/puzzles/bijutsukan/>*
4. (I ) *<https://www.puzzle-light-up.com/>*
5. (I S) *<http://www.puzzlepnic.com/genre?lightup>*
6. (I S) *<https://www.chiark.greenend.org.uk/~sgtatham/puzzles/js/lightup.html>*  
sur ce site, les dimensions de la grille et le niveau de difficulté peuvent être choisis

### Anglers

1. (I S) *<https://www.janko.at/Raetsel/Anglers/index.htm>*
2. (I S) *<http://puzzlepnic.com/genre?anglers>*

## Aquarium

1. (I S) [www.janko.at/Raetsel/Wasserspass/index.htm](http://www.janko.at/Raetsel/Wasserspass/index.htm)
2. ( S) <https://www.puzzle-aquarium.com/>
3. (I S) <http://www.puzzlepicnic.com/genre?waterfun>

## Arukone — Numberlink

1. (I S) <http://www.menneske.no/arukone/eng/>
2. (I ) <https://www.lsrhs.net/faculty/seth/Puzzles/numberLink/numberLink.htm>
3. (I S) <http://nikoli.com/en/puzzles/numberlink/>
4. (I S) <https://www.janko.at/Raetsel/Arukone/index.htm>
5. (I S) <https://www.janko.at/Raetsel/Arukone-2/index.htm>
6. (I S) <http://www.puzzlepicnic.com/genre?numberlink>

## Bataille navale — Battleship

1. (I S) <https://www.janko.at/Raetsel/Battleships/index.htm>
2. (IQS) <https://www.brainbashers.com/battleships.asp>
3. (I ) <https://www.mindgames.com/game/Daily+Battleship+Solitaire>
4. ( S) <https://krazydad.com/battleships/>
5. ( S) <http://www.infinimath.com/jeuxetstrategie/TJS27.pdf>  
d'autres pages en ligne en remplaçant dans l'adresse précédente 27 par 29, 30, 31, 32, 33, 34, 35, 36, 37, 38, 39, 40 et 41

## Binero — Takuzu

1. (I ) <http://www.kastete.fr/takuzu-binero>
2. (IQ ) <http://www.20minutes.fr/services/takuzu>
3. (I S) <http://www.sudoku-land.com/binero/binero.php>
4. ( ) [http://www.educmat.fr/categories/jeux\\_reflexion/fiches\\_jeux/binero/b](http://www.educmat.fr/categories/jeux_reflexion/fiches_jeux/binero/b)
5. (I ) <https://krazydad.com/binox/>
6. ( ) « Binero », collection « Sport Cérébral », dans les librairies

## Briques

1. (I S) <https://www.janko.at/Raetsel/Ziegelmauer/index.htm>
2. (I S) <http://www.tectonicpuzzel.eu/bricks-puzzle-online-solver.html>

## Burokku

(I S) <https://www.janko.at/Raetsel/Burokku/index.htm>

## Catwalk

(I S) <http://puzzlepnic.com/genre?catwalk>

## Clôture — Slither Link — Surizarinku — Loop the loop

1. (I S) <https://www.janko.at/Raetsel/Slitherlink/index.htm>
2. (I ) <https://fr.puzzle-loop.com/>
3. (IQS) <https://www.brainbashers.com/slitherlink.asp>
4. (I S) <http://www.conceptispuzzles.com/?uri=puzzle/slitherlink>
5. (I S) <http://www.nikoli.com/en/puzzles/slitherlink/>
6. (I S) <https://www.chiark.greenend.org.uk/~sgtatham/puzzles/js/loopy.html>  
sur ce site, les dimensions de la grille et le niveau de difficulté peuvent être choisis
7. ( S) <https://krazydad.com/slitherlink/>
8. (IQ ) <https://www.mindgames.com/game/Daily+Loop>
9. ( S) <http://www.infinimath.com/jeuxetstrategie/TJS27.pdf>  
d'autres pages en ligne en remplaçant dans l'adresse précédente 27 par 28, 29, 30, 31, 32, 33, 35, 36, 37, 38, 39, 40 et 41

## Démineur

1. (I S) <https://www.janko.at/Raetsel/Minesweeper/index.htm>
2. ( S) <http://www.infinimath.com/jeuxetstrategie/TJS27.pdf>  
d'autres pages en ligne en remplaçant dans l'adresse précédente 27 par 28
3. ( S) « Le jeu du démineur », Éd. Pole, 2003

## Diamants

(I S) <http://www.puzzlepicnic.com/genre?diamonds>

## Disconnect Four

1. (I S) <http://puzzlepicnic.com/genre?disconnectfour>
2. ( I ) [http://mzrg.com/js/disconnect\\_four.html](http://mzrg.com/js/disconnect_four.html)

## Dominion

(I S) <https://www.janko.at/Raetsel/Dominion/index.htm>

## Dominos

1. (I S) <https://www.janko.at/Raetsel/Dominos/index.htm>
2. (I S) <http://www.puzzlepicnic.com/genre?domino>
3. (I S) <https://www.chiark.greenend.org.uk/~sgtatham/puzzles/js/dominosa.htm>  
sur ce site, les dimensions de la grille et le niveau de difficulté peuvent être choisis
4. ( S ) <http://www.puzzlemochalovlp.com/Domin/ogl.htm>
5. ( S ) Brochure « Jeux 6 », n° 144, APMEP, 2002
6. ( S ) <http://www.infinimath.com/jeuxetstrategie/TJS28.pdf>  
d'autres pages en ligne en remplaçant dans l'adresse précédente 28 par 29, 31, 32, 33, 35, 36 et 37

## Doughnut

(I S) <https://www.janko.at/Raetsel/Doughnut/index.htm>

## Entrée-Sortie — Entry-Exit

(I S) <https://www.janko.at/Raetsel/Entry-Exit/index.htm>

## Eulero

(I S) <https://www.janko.at/Raetsel/Eulero/index.htm>

## Faktorism

(I S) <https://www.janko.at/Raetsel/Faktorism/index.htm>

## Fillomino

1. (I S) <http://www.menneske.no/fillomino/eng/>
2. (I S) <https://www.janko.at/Raetsel/Fillomino/index.htm>
3. (IQS) <https://www.brainbashers.com/fillomino.asp>
4. (I S) <http://www.puzzlepicnic.com/genre?fillomino>

## Fobidoshi

1. (I S) <https://www.janko.at/Raetsel/Fobidoshi/index.htm>
2. (I S) <https://www.lsrhs.net/faculty/seth/Puzzles/fobidoshi/fobidoshi.html>
3. (IQS) <https://www.psicoactiva.com/juegos-inteligencia/fobidoshi/>

## Futoshiki — Inégal

1. (I S) <https://www.futoshiki.org/>  
sur ce site, les dimensions de la grille et le niveau de difficulté peuvent être choisis
2. (I S) <https://fr.goobix.com/jeux-en-ligne/futoshiki/>
3. (I S) <https://www.janko.at/Raetsel/Futoshiki/index.htm>
4. (I S) <http://www.puzzlepicnic.com/genre?futoshiki>
5. (IQS) <https://www.brainbashers.com/futoshiki.asp>
6. (I S) <https://krazydad.com/futoshiki/>
7. (I S) <https://www.chiark.greenend.org.uk/~sgtatham/puzzles/js/unequal.html>  
sur ce site, les dimensions de la grille et le niveau de difficulté peuvent être choisis

## Fuzuli

( S) <https://www.janko.at/Raetsel/Fuzuli/index.htm>

## Galaxies — Tentai Show

1. (I S) <https://www.chiark.greenend.org.uk/~sgtatham/puzzles/js/galaxies.h>  
sur ce site, les dimensions de la grille et le niveau de difficulté peuvent être choisis
2. (I S) <https://www.janko.at/Raetsel/Galaxien/index.htm>
3. (I S) <https://krazydad.com/galaxies/>

## Gappy

(I S) <https://www.janko.at/Raetsel/Gappy/index.htm>

## Grades

1. (I S) <https://www.janko.at/Raetsel/Grades/index.htm>
2. (I S) <http://www.puzzlepicnic.com/genre?grades>

## Gratte-ciel

1. (IQS) <https://www.brainbashers.com/skyscrapers.asp>
2. (I S) <https://www.chiark.greenend.org.uk/~sgtatham/puzzles/js/towers.html>  
sur ce site, les dimensions de la grille et le niveau de difficulté peuvent être choisis
3. (I S) [http://www.educmat.fr/categories/jeux\\_reflexion/fiches\\_jeux/gratteciel](http://www.educmat.fr/categories/jeux_reflexion/fiches_jeux/gratteciel)
4. (I ) <https://www.gridblers.net/sudoku/-/sudoku/Skyscraper>
5. (I S) <http://www.conceptispuzzles.com/index.aspx?uri=puzzle/skyscrapers>
6. (I S) <http://www.puzzlepicnic.com/genre?flats>
7. (I S) [https://www.interactive.onlinemathlearning.com/fun\\_towers.php](https://www.interactive.onlinemathlearning.com/fun_towers.php)
8. ( S) « Le jeu du gratte-ciel », B. Novelli et M. Rivière, Coll. « Jeux Tangente », Éd. Pole, 2003
9. ( S) <http://www.infinimath.com/jeuxetstrategie/TJS27.pdf>  
d'autres pages en ligne en remplaçant dans l'adresse précédente 27 par 28, 30, 31, 32, 33, 34 et 35

## Gyokuseki

(I S) <https://www.janko.at/Raetsel/Gyokuseki/index.htm>

## Haltères

( S ) <http://www.infinimath.com/jeuxetstrategie/TJS27.pdf>  
d'autres pages en ligne en remplaçant dans l'adresse précédente 27 par 28

## Hamilton

( I S ) <http://www.puzzlepicnic.com/genre?hamiltonmaze>

## Hanare

( I S ) <https://www.janko.at/Raetsel/Hanare/index.htm>

## Hidoku

1. ( I S ) <https://www.janko.at/Raetsel/Hidoku/index.htm>
2. ( I S ) <http://hidoku-solver.appspot.com/>

## Hitori

1. ( IQS ) <https://www.brainbashers.com/hitori.asp?>
2. ( IQS ) <http://www.conceptispuzzles.com/index.aspx?uri=puzzle/hitori>
3. ( I S ) <https://www.janko.at/Raetsel/Hitori/index.htm>
4. ( I S ) <http://www.jlsigrist.com/hitoris06/hitoris1.html>
5. ( I S ) <http://www.menneske.no/hitori/eng/>
6. ( I S ) <http://www.nikoli.com/en/puzzles/hitori/>
7. ( I S ) <http://www.puzzlepicnic.com/genre?hitori>
8. ( S ) <http://www.infinimath.com/jeuxetstrategie/TJS27.pdf>  
d'autres pages en ligne en remplaçant dans l'adresse précédente 27 par 29 et 30

## Kakkuru

1. ( I S ) <https://www.janko.at/Raetsel/Lateinische-Summen/index.htm>
2. <https://www.streetinfo.lu/computing/lazarus/doc/Kakkuru.html>  
(application à télécharger)



## Kakurasu

1. (I S) <https://www.janko.at/Raetsel/Kakurasu/index.htm>
2. (IQS) <https://www.brainbashers.com/kakurasu.asp>
3. (I ) <https://fr.puzzle-kakurasu.com/>
4. (IQ ) <https://cdn.htmlgames.com/DailyKakurasu/index.html?bgcolor=white>

## Knossos

1. (I S) <https://www.janko.at/Raetsel/Knossos/index.htm>

## Kuromasu

1. ( S) <http://www.infinimath.com/jeuxetstrategie/TJS36.pdf>  
d'autres pages en ligne en remplaçant dans l'adresse précédente 36 par 36, 37, 38, 39, 40 et 41
2. (I S) <https://www.chiark.greenend.org.uk/~sgtatham/puzzles/js/range.html>  
sur ce site, les dimensions de la grille et le niveau de difficulté peuvent être choisis
3. (I ) <https://www.lsrhs.net/faculty/seth/Puzzles/kuromasu/kuromasu.html>
4. (I S) <https://www.janko.at/Raetsel/Kuromasu/index.htm>

## Magnets

1. (I S) <https://www.chiark.greenend.org.uk/~sgtatham/puzzles/js/magnets.htm>  
sur ce site, les dimensions de la grille et le niveau de difficulté peuvent être choisis
2. (I S) <https://www.janko.at/Raetsel/Magnete/index.htm>
3. (I S) <http://puzzlepicnic.com/genre?magnets>

## Marguerite

- ( S) Brochure « Jeux 6 », n° 144, APMEP, 2002

## Mastermind

1. (I S) <https://www.janko.at/Raetsel/Mastermind/index.htm>
2. (I S) <http://www.puzzlepicnic.com/genre?mastermind>

## Meadows

1. (I S) <https://www.janko.at/Raetsel/Meadows/index.htm>
2. ( S) <https://puzzlephil.com/puzzles/kuhweide/en/>

## Météo

( S) <http://www.infinimath.com/jeuxetstrategie/TJS32.pdf>  
d'autres pages en ligne en remplaçant dans l'adresse précédente 32 par 33, 34, 35, 36, 37, 38 et 39

## Mintonette

(I S) <https://www.janko.at/Raetsel/Mintonette/index.htm>

## Miroirs

1. (I S) <https://www.janko.at/Raetsel/Spukschloss/index.htm>
2. (I S) <https://www.chiark.greenend.org.uk/~sgtatham/puzzles/js/undead.html>  
sur ce site, les dimensions de la grille et le niveau de difficulté peuvent être choisis

## Morphism

(I S) <http://www.puzzlepicnic.com/genre?morphism>

## Nombres en chaîne – Meandering Numbers

(I S) <https://www.janko.at/Raetsel/Maeanderzahlen/index.htm>

## Nondango

(I S) <https://www.janko.at/Raetsel/Nondango/index.htm>

## Number Cross

(I S) <https://www.janko.at/Raetsel/Zahlenkreuz/index.htm>

## Patchwork — Tatami

(I S) <https://www.janko.at/Raetsel/Patchwork/index.htm>

## Perles — Masyu

1. ( S) <https://krazydad.com/masyu/>
2. (I ) [http://www.educmat.fr/categories/jeux\\_reflexion/fiches\\_jeux/masyu/ma](http://www.educmat.fr/categories/jeux_reflexion/fiches_jeux/masyu/ma)
3. (I S) <https://www.janko.at/Raetsel/Masyu/index.htm>
4. (I S) <https://www.chiark.greenend.org.uk/~sgtatham/puzzles/js/pearl.html>  
sur ce site, les dimensions de la grille et le niveau de difficulté peuvent être choisis
5. (I S) [https://www.interactive.onlinemathlearning.com/fun\\_pearl.php](https://www.interactive.onlinemathlearning.com/fun_pearl.php)
6. (I S) <http://puzzlepicnic.com/genre?masyu>

## Phares

(I S) <https://www.janko.at/Raetsel/Leuchttuerme/index.htm>

## Pipelink

(I S) <https://www.janko.at/Raetsel/Pipelink/index.htm>

## Ponts — Bridges — Hashiwokakero

1. (I S) <http://www.hashi.info/>
2. (I S) <https://www.janko.at/Raetsel/Hashi/index.htm>
3. (I ) <https://fr.puzzle-bridges.com/>
4. (IQS) <https://www.brainbashers.com/bridges.asp>
5. (I S) <http://www.menneske.no/hashis/eng/>
6. (I S) <http://www.nikoli.com/en/puzzles/hashiwokakero/>
7. (I ) <https://krazydad.com/tablet/slitherlink/>

## Portes — Seethrough

1. (I S) <http://www.puzzlepicnic.com/genre?seethrough>
2. (I S) <https://www.janko.at/Raetsel/Tueren/index.htm>

## Rectangles — Sikaku

1. (I S) <https://www.chiark.greenend.org.uk/~sgtatham/puzzles/js/rect.html>  
sur ce site, les dimensions de la grille et le niveau de difficulté peuvent être choisis
2. (I S) <https://www.janko.at/Raetsel/Sikaku/index.htm>
3. (I S) <http://www.puzzlepicnic.com/puzzles/genre?rectangles>

## Roma

(I S) <https://www.janko.at/Raetsel/Roma/index.htm>

## Ruisseau — Kuriku

(I S) <https://www.janko.at/Raetsel/Creek/index.htm>

## Salto

1. ( S) <http://www.infinimath.com/jeuxetstrategie/TJS40.pdf>
2. ( S) <http://www.infinimath.com/jeuxetstrategie/TJS41.pdf>

## Serpent — Snake — Tunnel

(I S) <https://www.janko.at/Raetsel/Schlange/index.htm>

## Shirokuro

(I S) <https://www.janko.at/Raetsel/Shirokuro/index.htm>

## Slant

1. (I S) <https://www.chiark.greenend.org.uk/~sgtatham/puzzles/js/slant.html>  
sur ce site, les dimensions de la grille et le niveau de difficulté peuvent être choisis
2. (IQS) <https://www.brainbashers.com/slant.asp>
3. (I S) <https://www.janko.at/Raetsel/Gokigen-Naname/index.htm>
4. (I S) <http://puzzlepicnic.com/genre?slant>

## Squaro

1. (I S) <http://eilathan29.canalblog.com/archives/2014/08/15/30419998.html>
2. (I S) <http://jlsigrist.com/squaro.html>
3. (I S) <https://www.flash-sudoku.com/index.php?p=clickG0&jeu=squar0>

## Star

1. (I S) <https://www.janko.at/Raetsel/Sternenschlacht/index.htm>
2. (I S) <http://puzzlepicnic.com/genre?starbattle>
3. ( ) <http://www.infinimath.com/jeuxetstrategie/TJS28.pdf>  
d'autres pages en ligne en remplaçant dans l'adresse précédente 28 par 30, 31, 32, 33, 34, 35, 36, 37, 38, 39, 40 et 41

## Stitches

1. (I S) <https://www.janko.at/Raetsel/Stitches/index.htm>
2. (I ) <https://www.puzzle-stitches.com/>  
sur ce site, les dimensions de la grille et le niveau de difficulté peuvent être choisis

## Sudoku

1. (IQS) <https://www.brainbashers.com/sudoku.asp>
2. (I ) <https://www.websudoku.com/>
3. (I S) <http://www.dailysudoku.com/sudoku/today.shtml>

## Sukoro

(I S) <https://www.janko.at/Raetsel/Sukoro/index.htm>

## Tairupeto

(I S) <https://www.janko.at/Raetsel/Tairupeinto/index.htm>

## Tentes — Tents & Trees

1. (IQS) <https://www.brainbashers.com/tents.asp>
2. (I S) <https://www.janko.at/Raetsel/Zeltlager/index.htm>
3. (I S) <http://www.puzzlepicnic.com/genre?tents>
4. (I S) <https://www.chiark.greenend.org.uk/~sgtatham/puzzles/js/tents.html>  
sur ce site, les dimensions de la grille et le niveau de difficulté peuvent être choisis

## Tetroid

(I S) <https://www.janko.at/Raetsel/Tetroid/index.htm>

## Thermomètres

1. (I S) <https://www.janko.at/Raetsel/Thermometer/index.htm>
2. ( S) <http://www.innoludic.com/fr/>
3. (I S) <http://puzzlepicnic.com/genre?thermometers>

## Toichika

( S) <https://www.janko.at/Raetsel/Toichika/index.htm>

## Tra-vers

( S) *Revue Tangente* Jeux et Stratégie, n° 19 et n° 22

## Trace Numbers

(I S) <https://www.janko.at/Raetsel/Trace-Numbers/index.htm>

## Tripletts

(I S) <https://www.janko.at/Raetsel/Tripletts/index.htm>

## **Voisins — Neighbours**

(IQS) <https://www.brainbashers.com/neighbours.asp>

## **Walls**

1. (I S) <https://www.janko.at/Raetsel/Mauerbau/index.htm>
2. (I S) <http://puzzlepicnic.com/genre?walls>

## **Yakuso**

1. (I S) <https://www.janko.at/Raetsel/Yakuso/index.htm>
2. (I S) <https://bertrandleplay.wixsite.com/yakuso>

## **Zehnergitter**

(I S) <https://www.janko.at/Raetsel/Zehnergitter/index.htm>

## **Zipline**

(I S) <https://www.janko.at/Raetsel/Zipline/index.htm>

## **Zwischenknick**

(I S) <https://www.janko.at/Raetsel/Zwischenknick/index.htm>